

LAPPSET®

FLORA







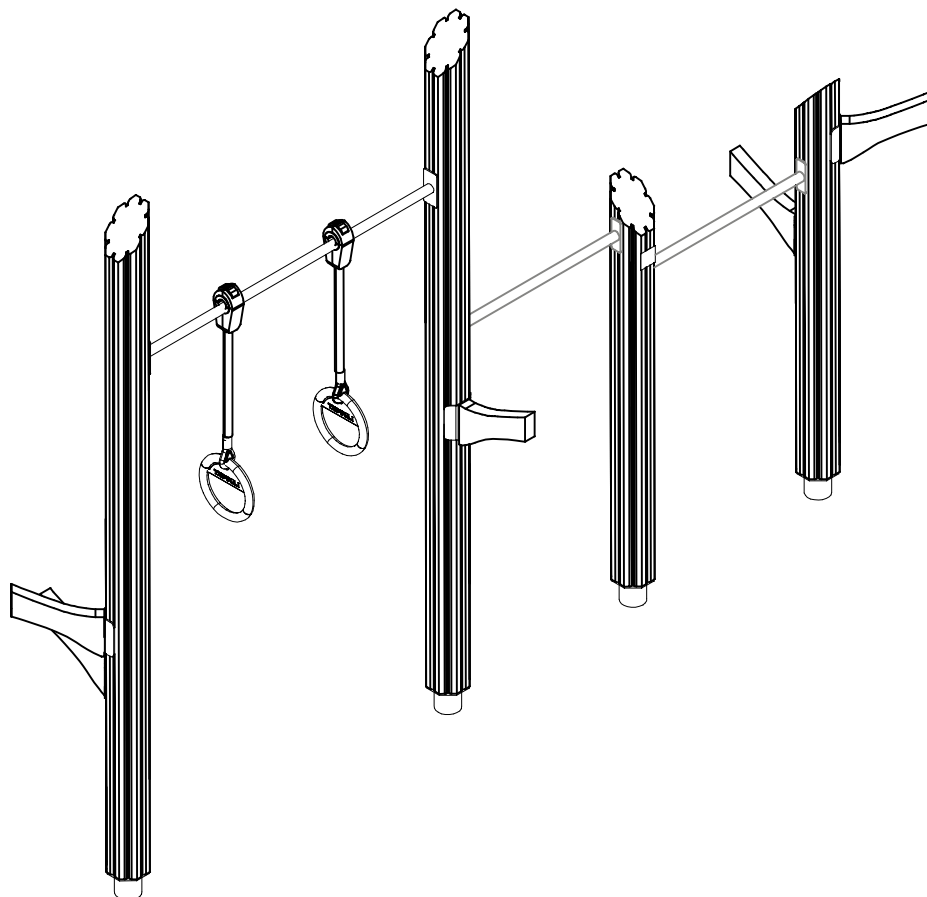



ASENNUSOHJE
MONTERINGSANSVISNING
INSTALLATION INSTRUCTION
AUFBAUANLEITUNG
NOTICE D'INSTALLATION

DATE: 5.5.2022

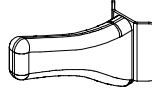
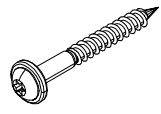
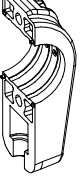
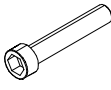
Q13179

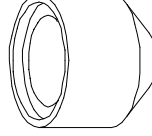
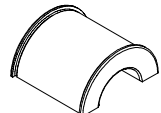
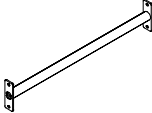
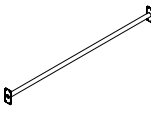

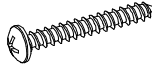
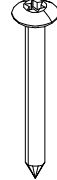
DATE: 5.5.2022

| | | | | | | | | | | | |
|--|----------|--|----------|--|----------|---|----------|---|-----------|--|-----------|
| 702286  65x65 | PCS 1 | 705040  Ø16x764 | PCS 2 | 705379  l=2594 | PCS 2 | 705393  l=1550 | PCS 2 | 705789  l=333 | PCS 5 | 900240  Ø8x70 | PCS 48 |
| 902195  150x50x50 | PCS 4 | 902232  M10x55 | PCS 2 | 902233  M10x30 | PCS 2 | 903112  l=750 | PCS 4 | 905104  M10 | PCS 32 | 906006  Ø64/36,4x59 | PCS 4 |
| 907694-216  L 704 | PCS 2 | 908017  L 1315 | PCS 1 | 909256  Ø16/8.4 | PCS 8 | 980114  Ø4x20 | PCS 4 | 980123  Ø7x60 | PCS 8 | 980161  M10 | PCS 4 |
| | PCS | | PCS | | PCS | | PCS | | PCS | | PCS |
| | PCS | | PCS | | PCS | | PCS | | PCS | | PCS |
| | PCS | | PCS | | PCS | | PCS | | PCS | | PCS |
| | PCS | | PCS | | PCS | | PCS | | PCS | | PCS |

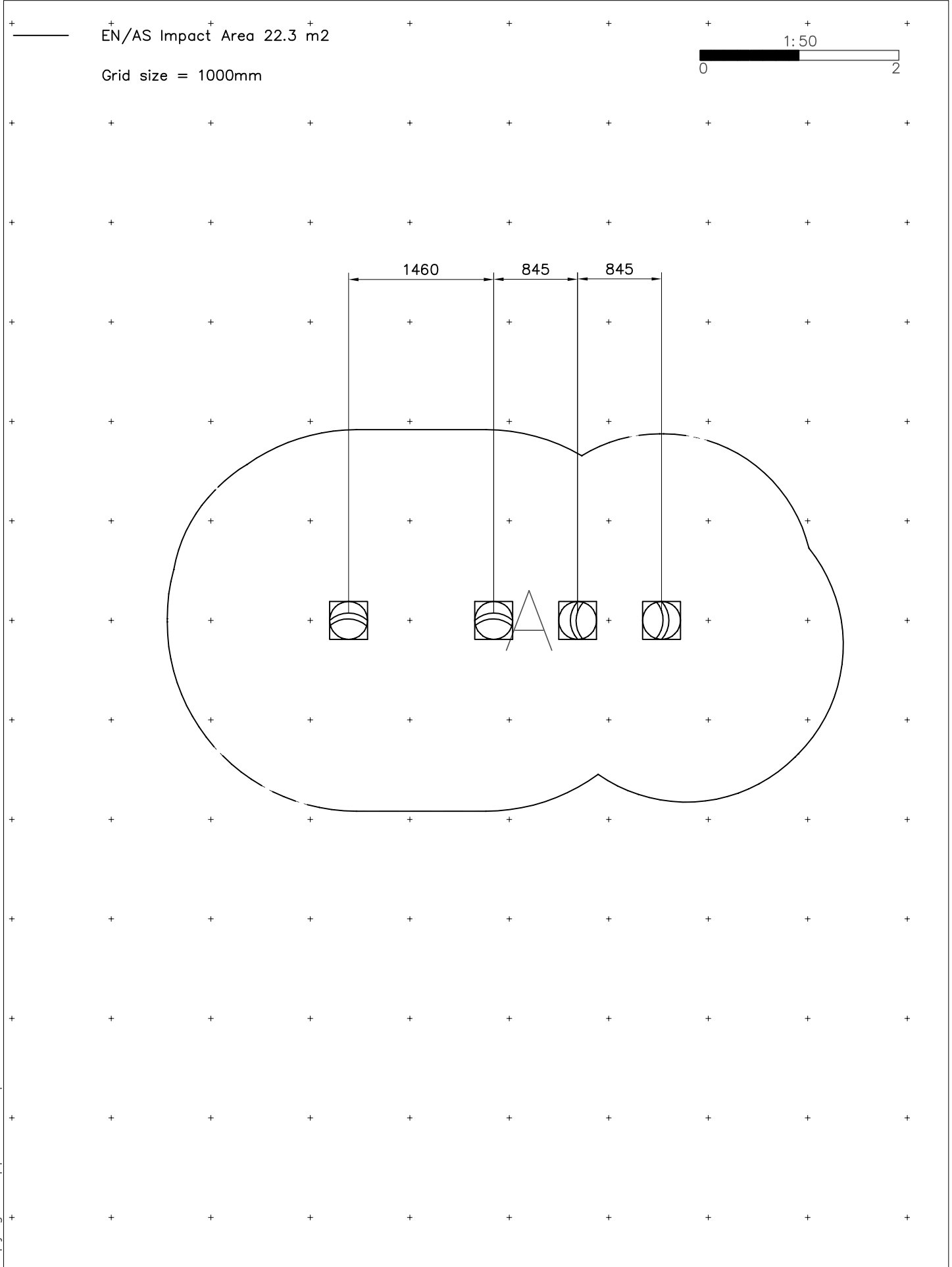

| | | |
|--|--|--|
| <p>Concrete 500x500x200</p> <p>Sand 0.2-2 mm/ Gravel 2-8 mm</p> <p>150</p> <p>600</p> <p>500</p> | <p>M10</p> <p>905104</p> <p>903112</p> | <p>Concrete 500x500x300</p> <p>Sand 0.2-2 mm/ Gravel 2-8 mm</p> <p>100</p> <p>650</p> <p>500</p> |
| | | |
| | | |
| | | |

- EN/AS Impact Area 22.3 m²
- Falling Space 22.3 m²
Max Falling Height 2100 mm

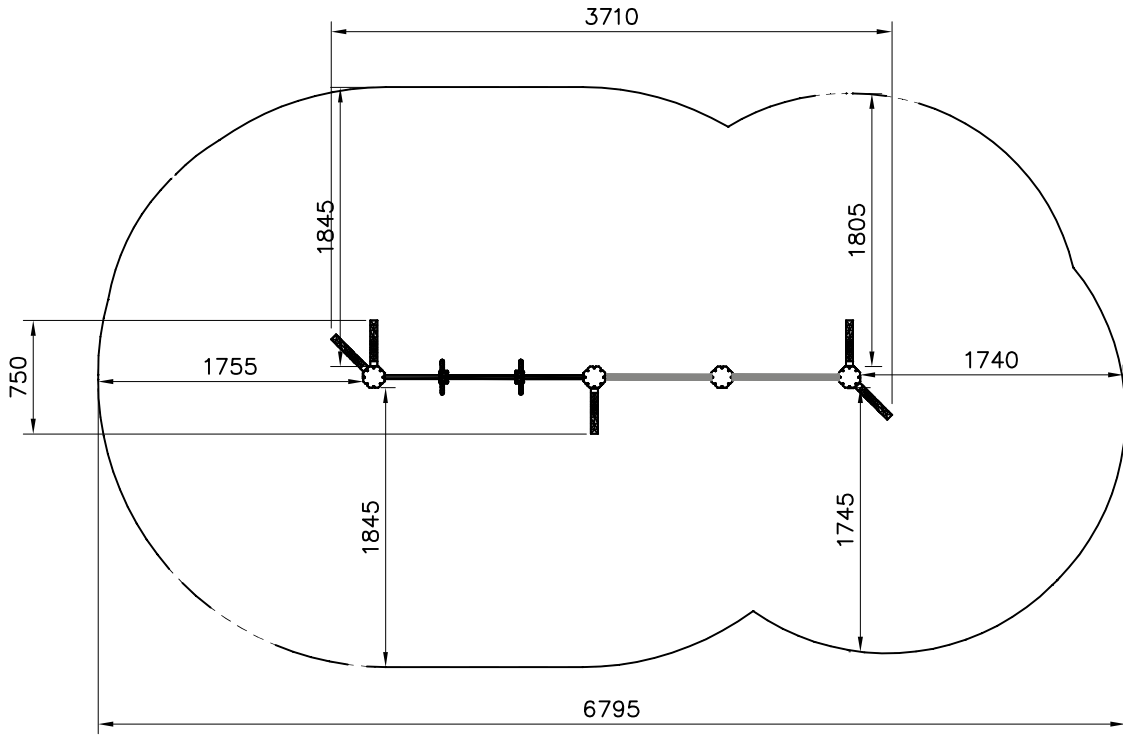
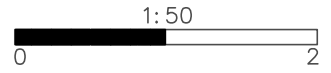

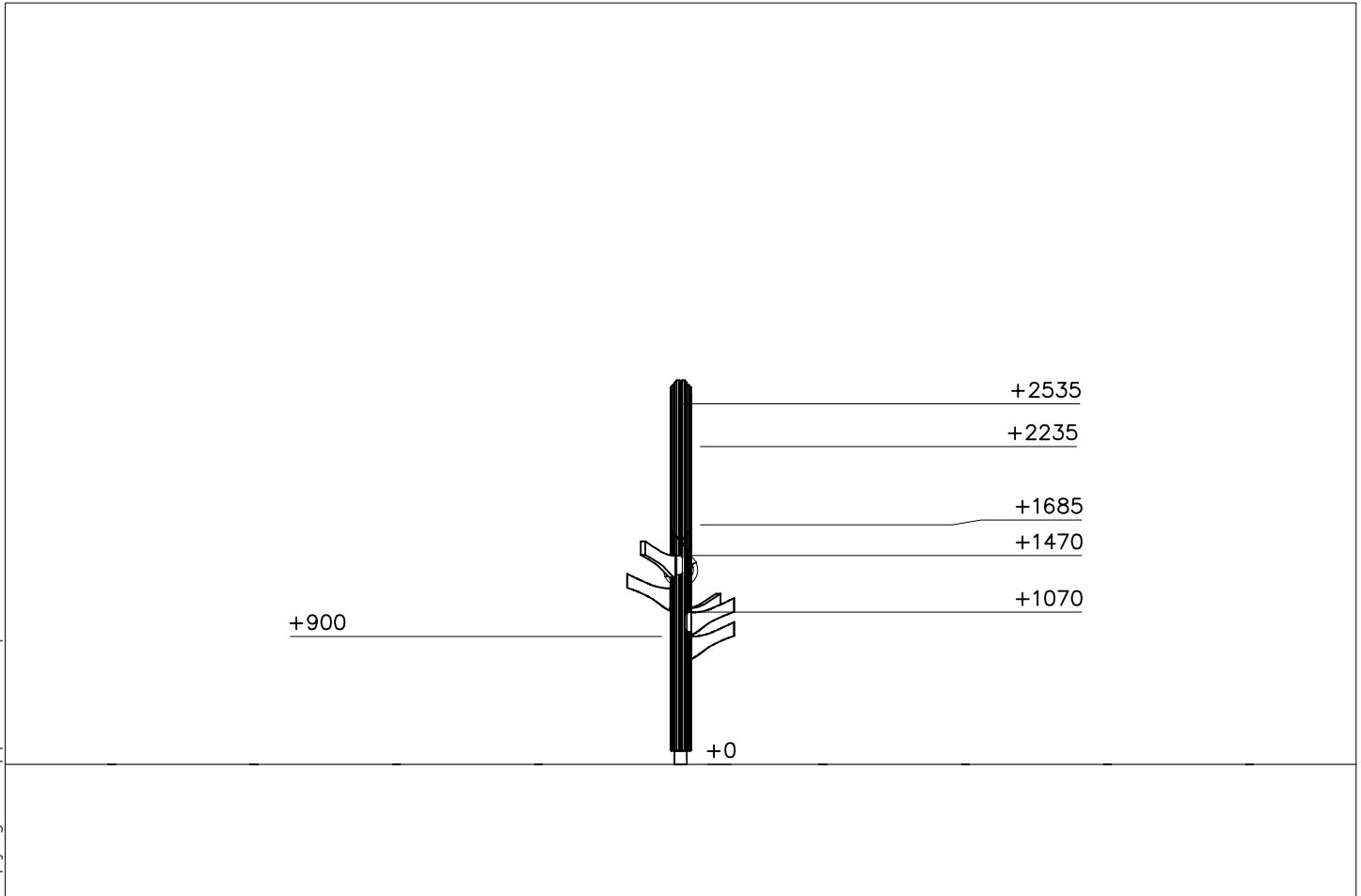
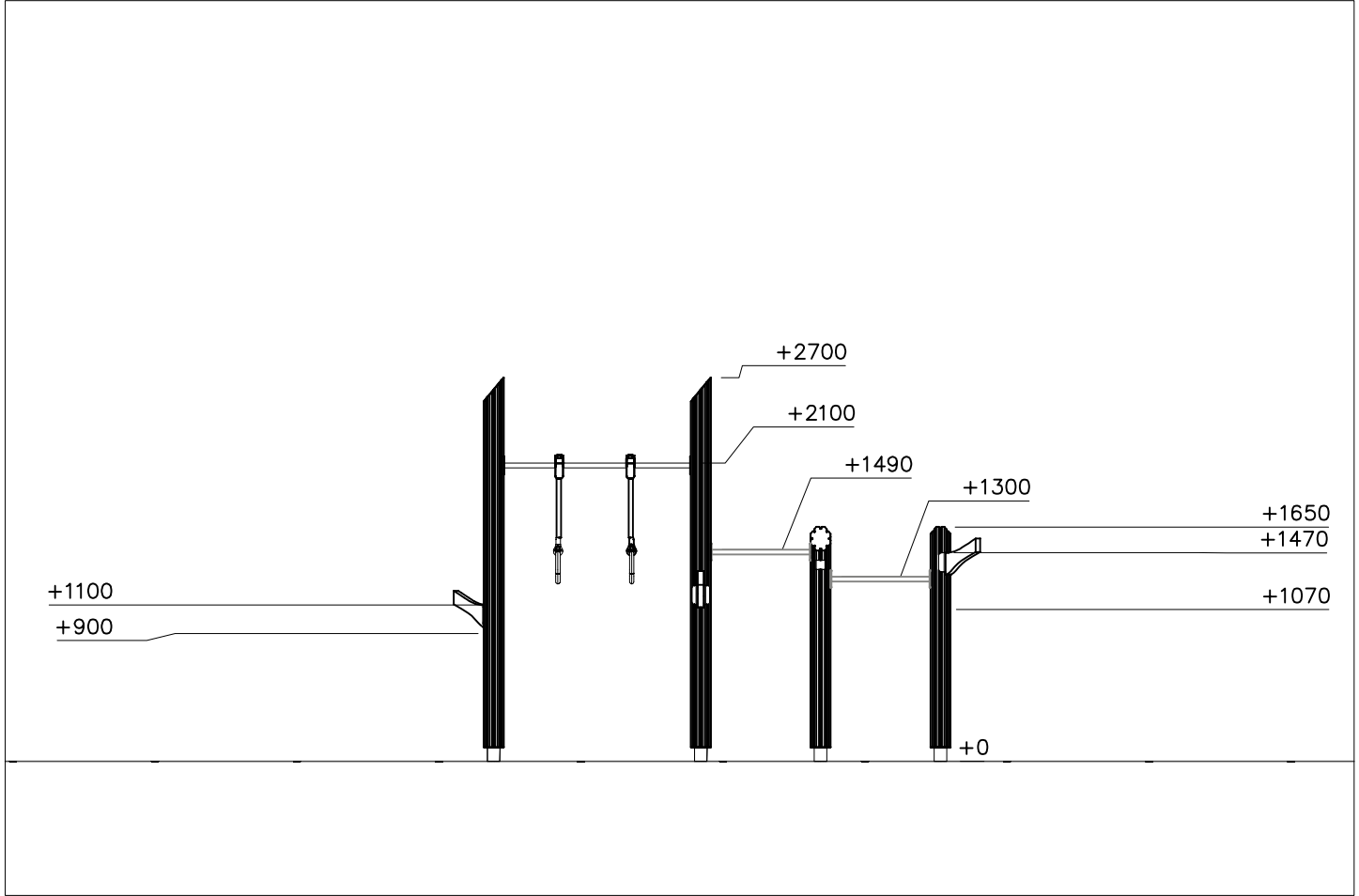

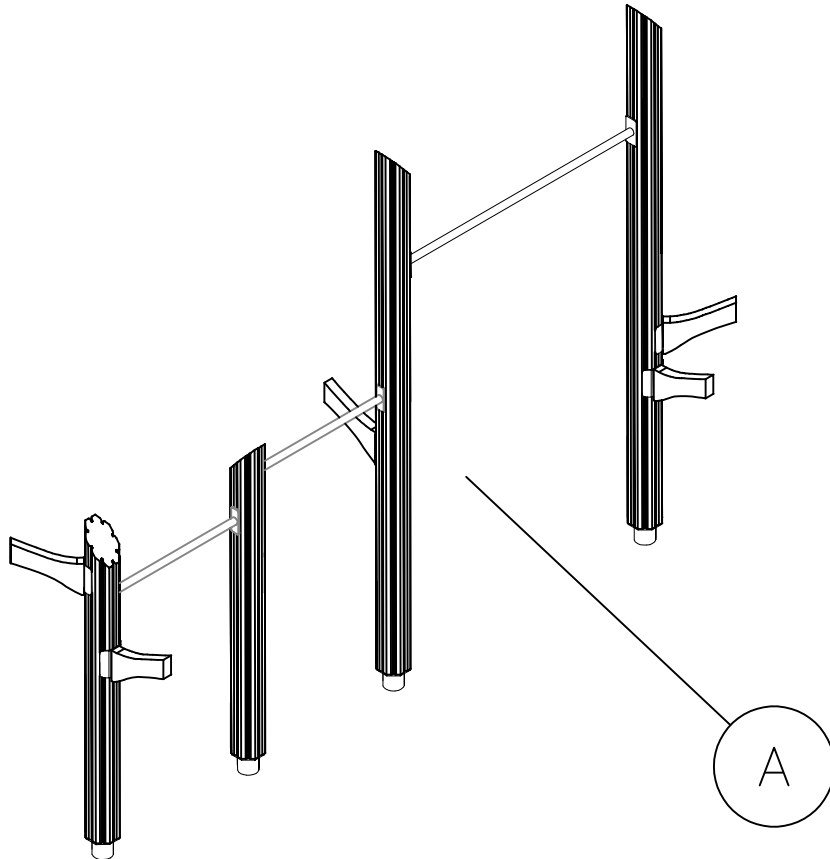
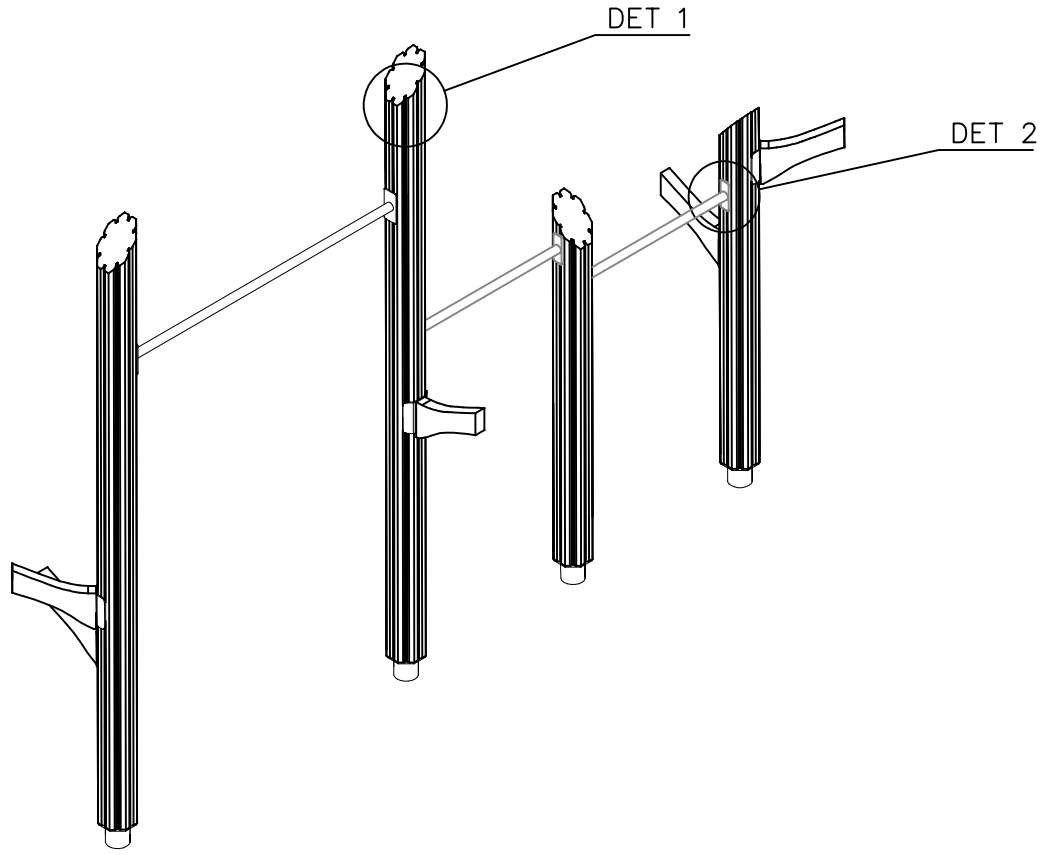

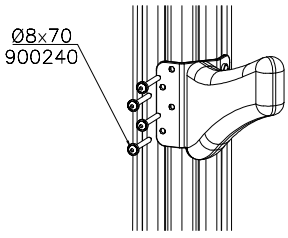
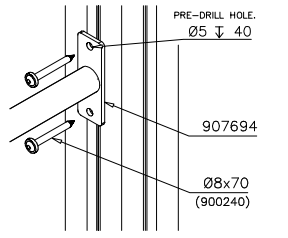
| | | | |
|--|---|--|--|
| <p>DET 1</p>  <p>Ø8x70 900240</p> | <p>DET 2</p>  <p>PRE-DRILL HOLE. Ø5 ↓ 40</p> <p>907694</p> <p>Ø8x70 (900240)</p> | | |
| | | | |
| | | | |
| | | | |
| | | | |



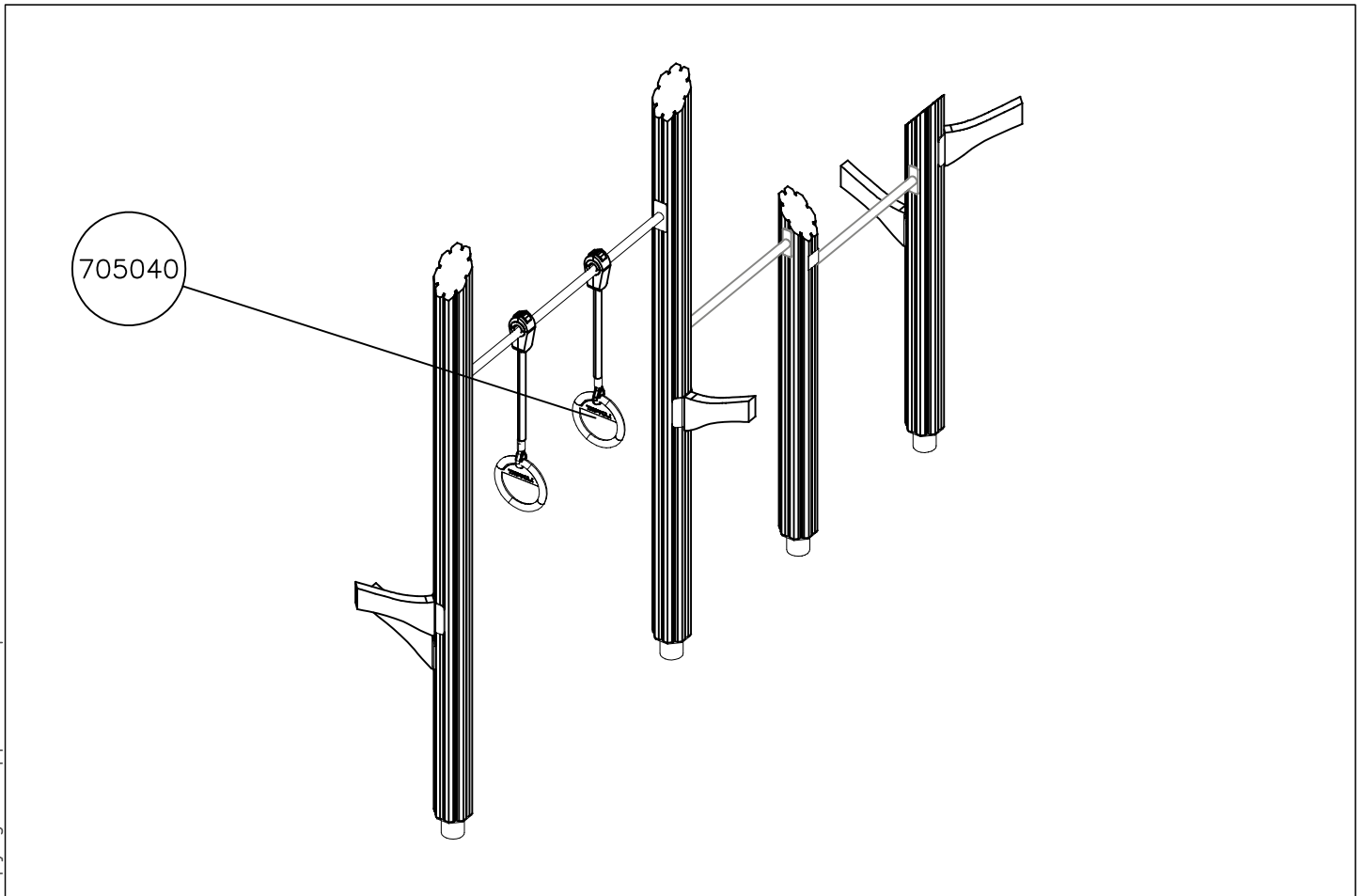
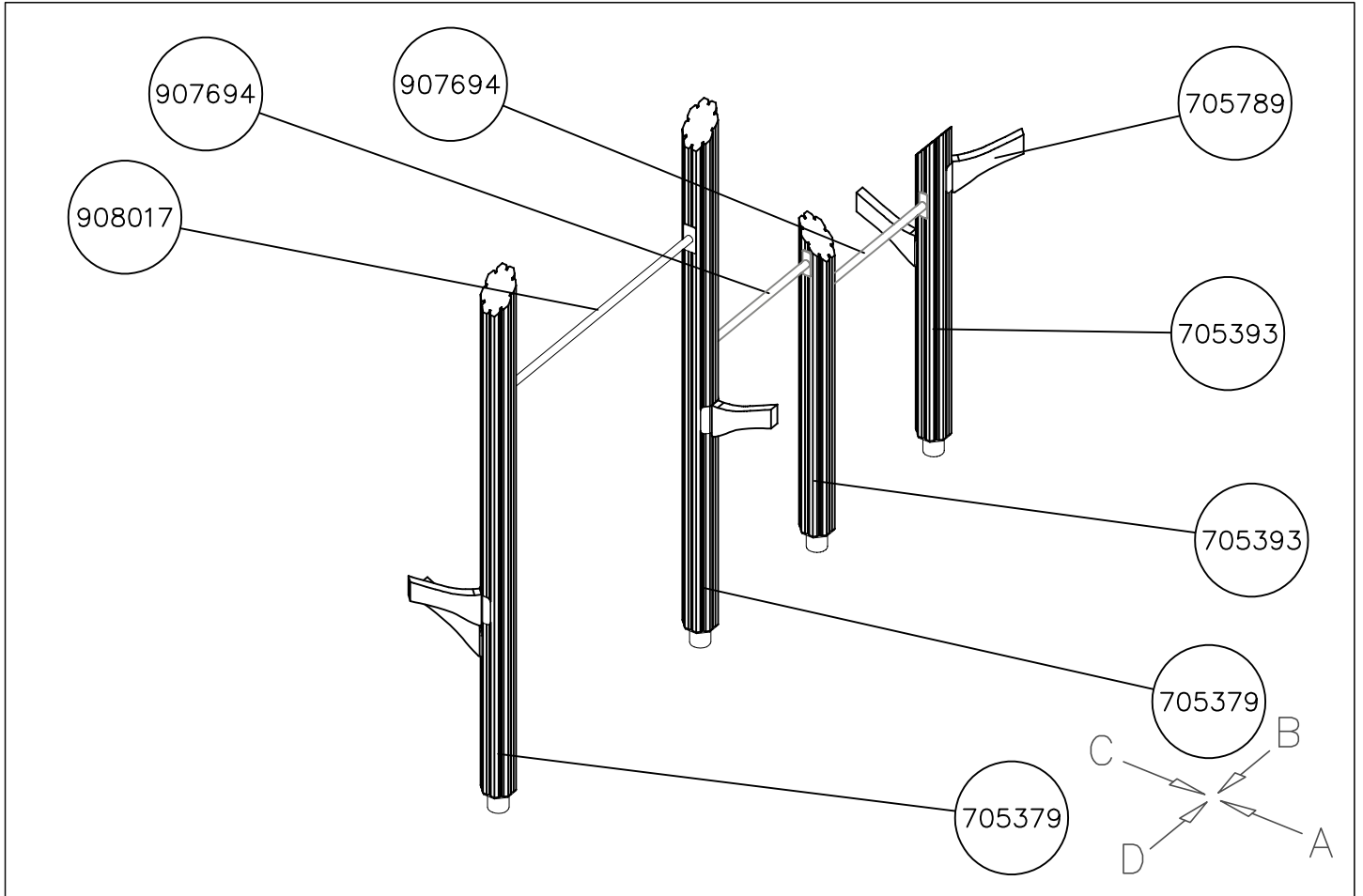

DATE: 5.5.2022

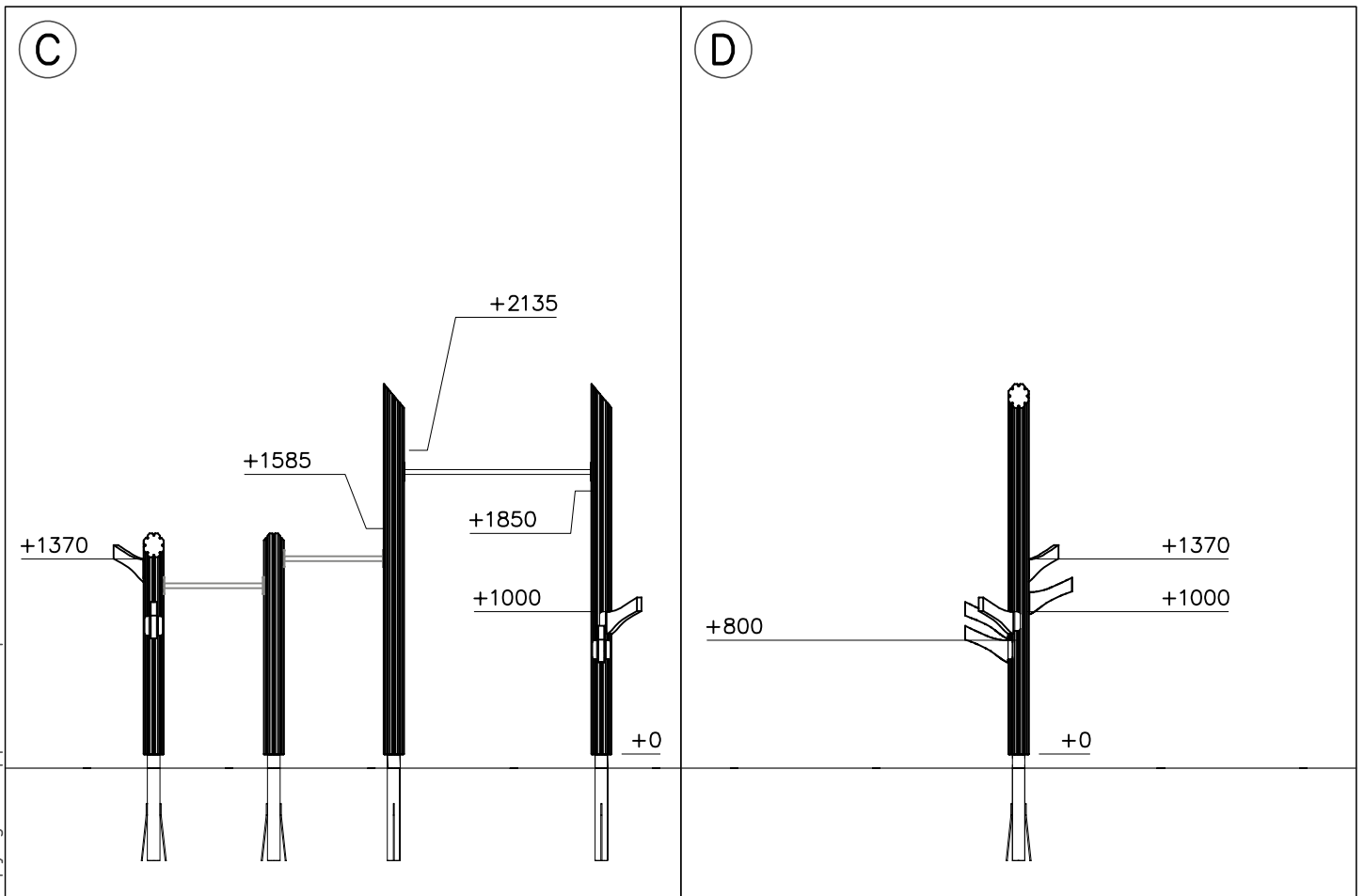
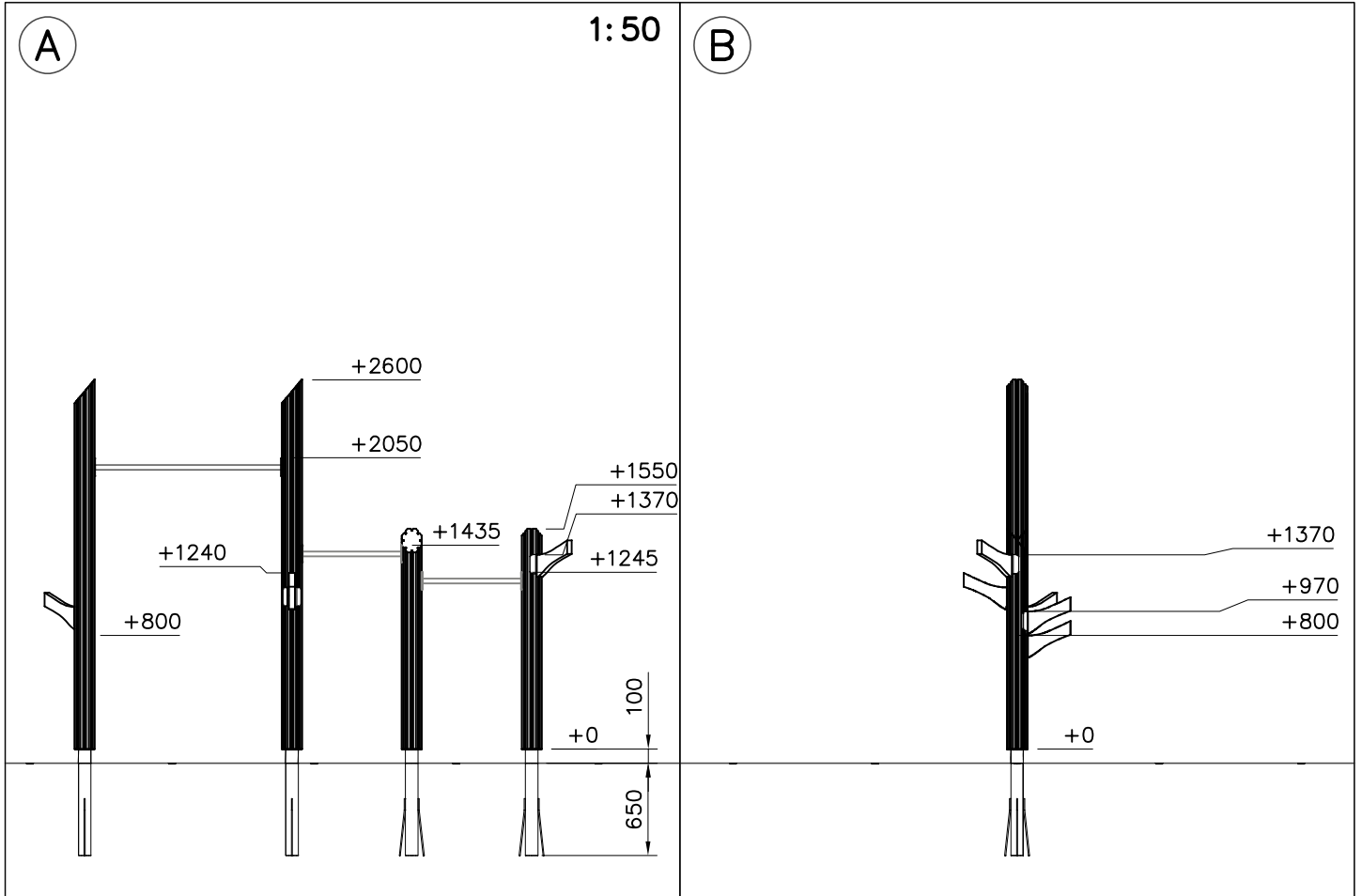

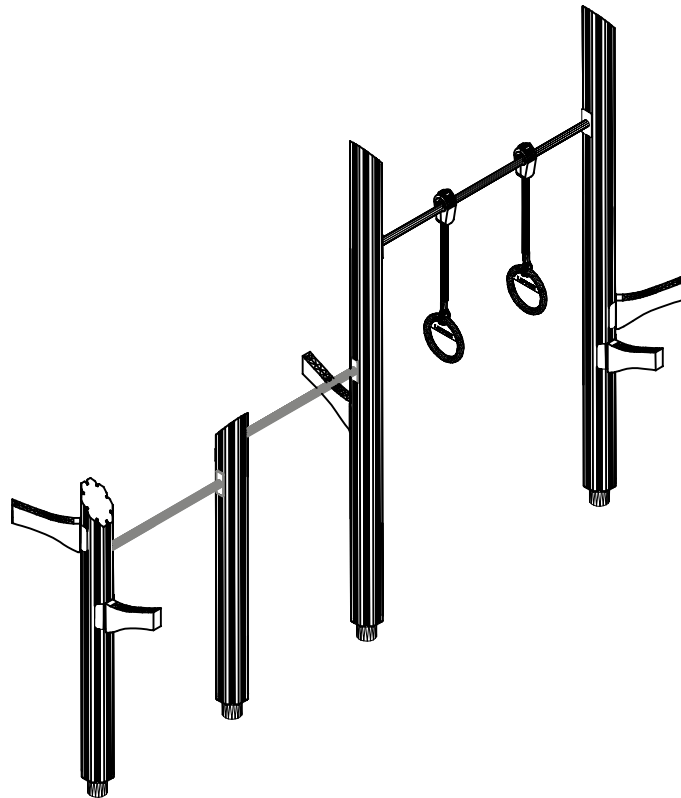
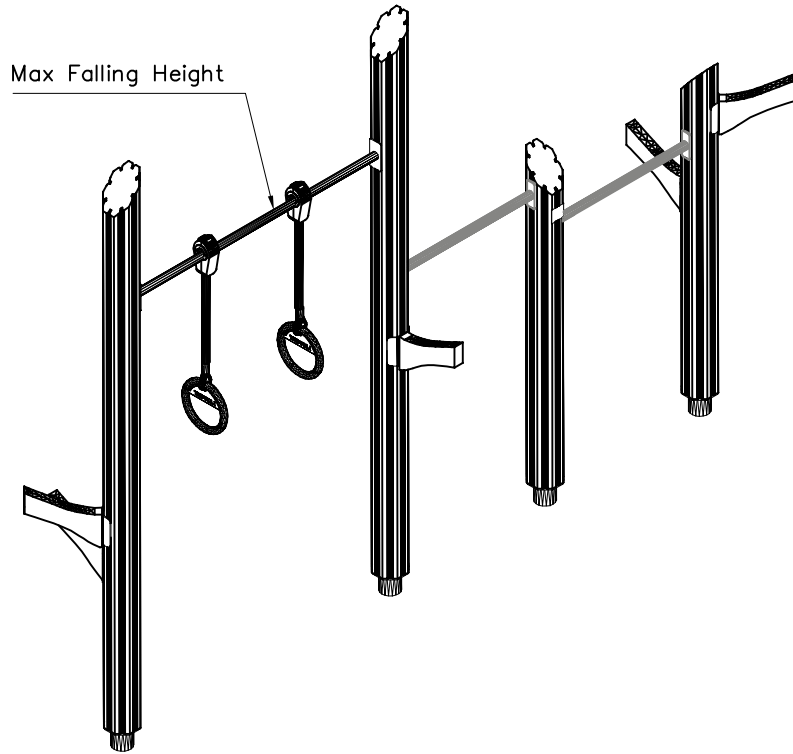
DATE: 5.5.2022

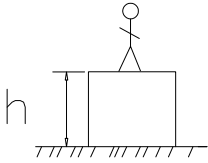

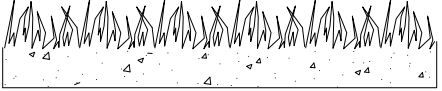
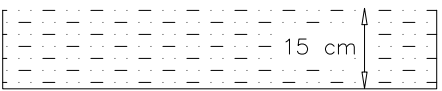
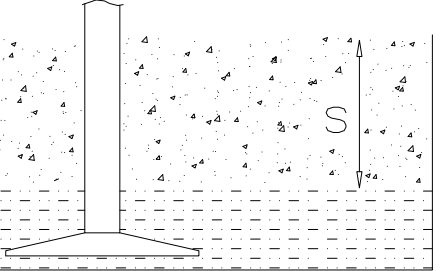
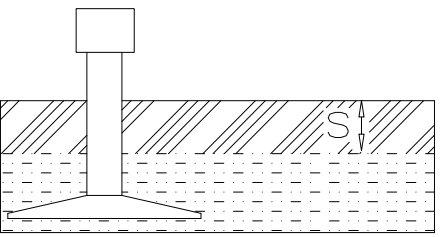

| | | | | | | | | | | | | |
|---|--|---|-----------------|-----------------|----------------|---------|----------------|---------|----------------|-------|----------------|---|
|  | | | | | | | | | | | | |
| <p>$h < 600$</p> <p>Without movement and therefore without Impact Area</p> | <p>Totally hard surfaces.</p> <p>Note. Lappset does <u>not recommend</u> totally hard surfaces at all.</p> | <p>E.g. concrete or asphalt</p>  | | | | | | | | | | |
| <p>$h < 600$</p> <p>With movement e.g. rocking</p> | <p>Materials with very limited impact attenuating properties.</p> | <p>E.g. wood</p>  | | | | | | | | | | |
| <p>$h < 1000$</p> | <p>Materials with significant impact attenuating properties.</p> | <p>fine gravel 0–8 mm</p>  <p>grass</p>  <p>unsorted sand</p>  | | | | | | | | | | |
| <p>$h < 3000$</p> | <p>Loose fill material</p> <p>E.g. sand/gravel 0,25...8 mm D60/D10<3,0 Woodchips 5...30 mm bark 20...80 mm</p> |  <table data-bbox="1024 1691 1332 1780"> <tr> <td>\underline{S}</td> <td>\underline{h}</td> </tr> <tr> <td>30 cm</td> <td>< 2,0 m</td> </tr> <tr> <td>40 cm</td> <td>< 3,0 m</td> </tr> </table> | \underline{S} | \underline{h} | 30 cm | < 2,0 m | 40 cm | < 3,0 m | | | | |
| \underline{S} | \underline{h} | | | | | | | | | | | |
| 30 cm | < 2,0 m | | | | | | | | | | | |
| 40 cm | < 3,0 m | | | | | | | | | | | |
| | <p>Syntethic granulates</p> <table data-bbox="406 1892 758 2060"> <tr> <td>\underline{S}</td> <td>\underline{h}</td> </tr> <tr> <td>40 mm</td> <td>~> 1,2...1,3 m</td> </tr> <tr> <td>50 mm</td> <td>~> 1,5...1,7 m</td> </tr> <tr> <td>60 mm</td> <td>~> 1,8...2,0 m</td> </tr> <tr> <td>70 mm</td> <td>~> 2,1...2,5 m</td> </tr> </table> <p>Note. For accurate values, see manufacturer's instructions.</p> | \underline{S} | \underline{h} | 40 mm | ~> 1,2...1,3 m | 50 mm | ~> 1,5...1,7 m | 60 mm | ~> 1,8...2,0 m | 70 mm | ~> 2,1...2,5 m |  |
| \underline{S} | \underline{h} | | | | | | | | | | | |
| 40 mm | ~> 1,2...1,3 m | | | | | | | | | | | |
| 50 mm | ~> 1,5...1,7 m | | | | | | | | | | | |
| 60 mm | ~> 1,8...2,0 m | | | | | | | | | | | |
| 70 mm | ~> 2,1...2,5 m | | | | | | | | | | | |

REMOVE SAFETY SURFACE/SAND/GRAVEL
TO CHECK FOUNDATION

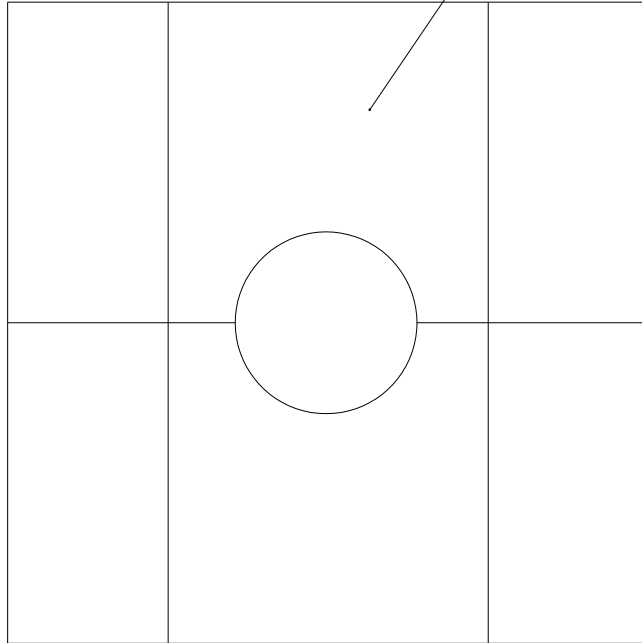

REMOVE SAFETY SURFACE/SAND/GRAVEL
TO CHECK FOUNDATION

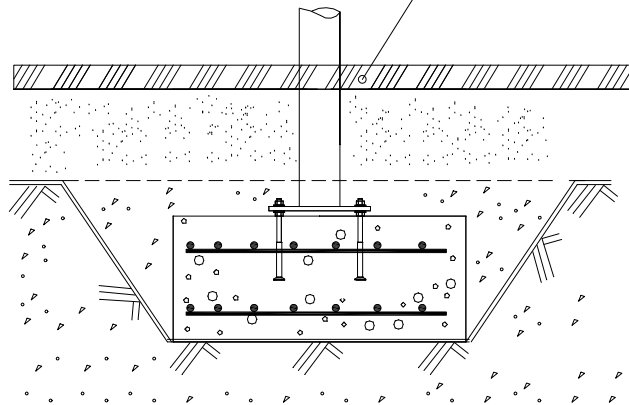

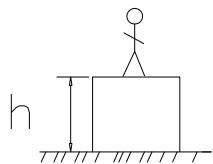

$h < 1000$

Totally hard surfaces or materials with very limited impact attenuating properties.

Totally hard surfaces.
E.g. concrete or asphalt



Case by case risk assessment is needed including e.g. evaluation whether there is forced movement, what is the intended exercise and where will the product be installed.

Materials with very limited impact attenuating properties.
E.g. wood



$h < 1200$

Materials with significant impact attenuating properties.

fine gravel 0–8 mm

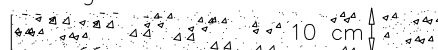

Unsorted sand/ topsoil

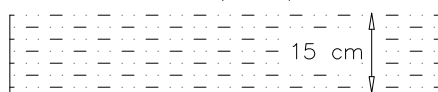

$h < 1500$

Lawn



$h < 3000$

Loose fill material

E.g.
sand/gravel 0,25...8 mm $D_{60}/D_{10} < 3,0$
Woodchips 5...30 mm
bark 20...80 mm

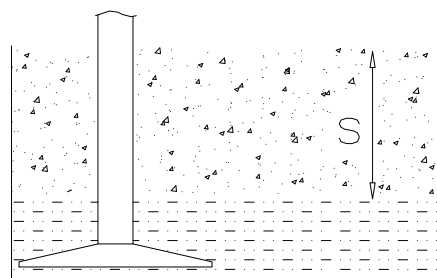

| | |
|-----------------|-----------------|
| \underline{S} | \underline{h} |
| 30 cm | $< 2,0$ m |
| 40 cm | $< 3,0$ m |

Syntetic granulates

| | |
|-----------------|----------------------|
| \underline{S} | \underline{h} |
| 40 mm | $\sim > 1,2...1,3$ m |
| 50 mm | $\sim > 1,5...1,7$ m |
| 60 mm | $\sim > 1,8...2,0$ m |
| 70 mm | $\sim > 2,1...2,5$ m |

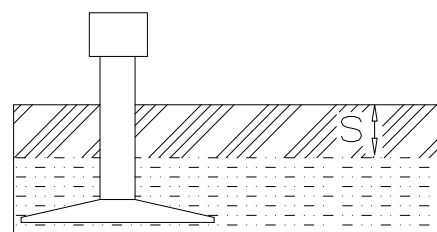

Note. For accurate values, see manufacturer's instructions.

LAPPSET® BETON FOUNDATION

FOOT

DATE: 27.10.2015

1(1)

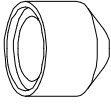
| | | | |
|---|-----|--|-----|
| ② 905104 | PCS | | PCS |
| | 4 | | |
|  | | | |
| | M10 | | |
| | PCS | | PCS |
| | | | |
| | | | |



905104

**Tuotekyltti tulee tuotteen mukana yhdellä seuraavista tavoista:****1) Metallinen tuotekyltti ja kiinnitysruuvit**

- Kiinnitä tuotekyltti ruuveilla tolppaan noin 2 metrin korkeuteen kuvan 1 mukaisesti.

2) Tuotekylttitarra

- Puhdista maalattu metalli- tai vaneripinta pölystä ja kosteudesta. Liimaa tarra kuvan 2 mukaisesti.
- Huom. Älä kiinnitä tarraa karheapintaiseen laminaattiin tai maalattuun puuhun.

Vår produktmärkning levereras på ett av följande sätt:**1) Produktskylt i metall**

- Fäst skylten med de medföljande skruvarna

2) Självhäftande produktetikett

- Rengör den pulverlackerade metallytan eller laminatyten så att den blir fri från smuts och fukt. Fäst etiketten enligt fig. 2.
- Obs! Fäst ej etiketten på detaljer med skrovlig yta eller på målat trä.

Product label is delivered by one of following ways:**1) Metal product label and screws**

- Fasten the label with screws.

2) Label sticker

- Clean the painted metal or plywood surface from dirt and moisture. Fasten the sticker as shown in the figure 2.
- Note. Do not attach the sticker to rough surfaced laminate or painted wood.

La plaque d'informations produit est livrée sous l'une de ces 3 formes :**1) Plaque métallique et vis**

- Fixez la plaque à l'aide des vis.

2) Etiquette autocollante

- Avant de coller l'étiquette, nettoyez le composant métallique peint ou la plaque de contreplaqué, de toute saleté. La surface doit être sèche (voir image 2).
- Attention, ne pas coller l'étiquette sur une surface lamellé-collée irrégulière ou sur du bois peint.

Die Auslieferung des Produktaufklebers erfolgt auf eine dieser Arten:**1) Produkt-Schild aus Metall incl. Schrauben**

- Die Befestigung des Schildes erfolgt mittels der Schrauben.

2) Aufkleber

- Entfernen Sie zunächst Schmutz und Feuchtigkeit vom lackierten Metall bzw. von der Holzoberfläche und bringen Sie den Aufkleber wie im Bild oben rechts beschrieben auf den gesäuberten Untergrund auf.
- Beachten Sie: Bringen Sie den Aufkleber nicht auf raues laminiertes oder lackiertes Holz an.