



												
<p>$h < 600$</p> <p>Without movement and therefore without Impact Area</p>	<p>Totally hard surfaces.</p> <p>Note. Lappset does <u>not recommend</u> totally hard surfaces at all.</p>	<p>E.g. concrete or asphalt</p> 										
<p>$h < 600$</p> <p>With movement e.g. rocking</p>	<p>Materials with very limited impact attenuating properties.</p>	<p>E.g. wood</p> 										
<p>$h < 1000$</p>	<p>Materials with significant impact attenuating properties.</p>	<p>fine gravel 0–8 mm</p>  <p>grass</p>  <p>unsorted sand</p> 										
<p>$h < 3000$</p>	<p>Loose fill material</p> <p>E.g.</p> <p>sand/gravel 0,25...8 mm $D_{60}/D_{10} < 3,0$</p> <p>Woodchips 5...30 mm</p> <p>bark 20...80 mm</p>	 <table data-bbox="1023 1693 1326 1787"> <tr> <td>\underline{S}</td> <td>\underline{h}</td> </tr> <tr> <td>30 cm</td> <td>$< 2,0$ m</td> </tr> <tr> <td>40 cm</td> <td>$< 3,0$ m</td> </tr> </table>	\underline{S}	\underline{h}	30 cm	$< 2,0$ m	40 cm	$< 3,0$ m				
\underline{S}	\underline{h}											
30 cm	$< 2,0$ m											
40 cm	$< 3,0$ m											
	<p>Syntethic granulates</p> <table data-bbox="408 1899 751 2056"> <tr> <td>\underline{S}</td> <td>\underline{h}</td> </tr> <tr> <td>40 mm</td> <td>$\sim > 1,2...1,3$ m</td> </tr> <tr> <td>50 mm</td> <td>$\sim > 1,5...1,7$ m</td> </tr> <tr> <td>60 mm</td> <td>$\sim > 1,8...2,0$ m</td> </tr> <tr> <td>70 mm</td> <td>$\sim > 2,1...2,5$ m</td> </tr> </table> <p>Note. For accurate values, see manufacturer's instructions.</p>	\underline{S}	\underline{h}	40 mm	$\sim > 1,2...1,3$ m	50 mm	$\sim > 1,5...1,7$ m	60 mm	$\sim > 1,8...2,0$ m	70 mm	$\sim > 2,1...2,5$ m	
\underline{S}	\underline{h}											
40 mm	$\sim > 1,2...1,3$ m											
50 mm	$\sim > 1,5...1,7$ m											
60 mm	$\sim > 1,8...2,0$ m											
70 mm	$\sim > 2,1...2,5$ m											

REMOVE SAFETY SURFACE/SAND/GRAVEL
TO CHECK FOUNDATION



REMOVE SAFETY SURFACE/SAND/GRAVEL
TO CHECK FOUNDATION

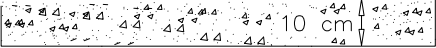
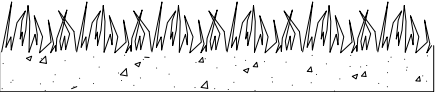

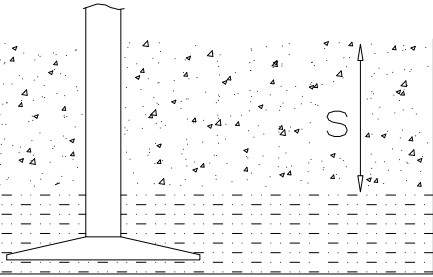
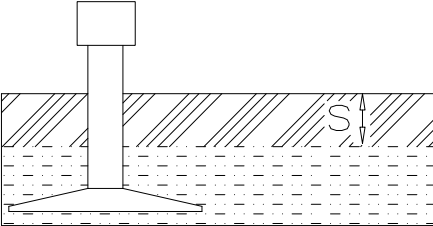
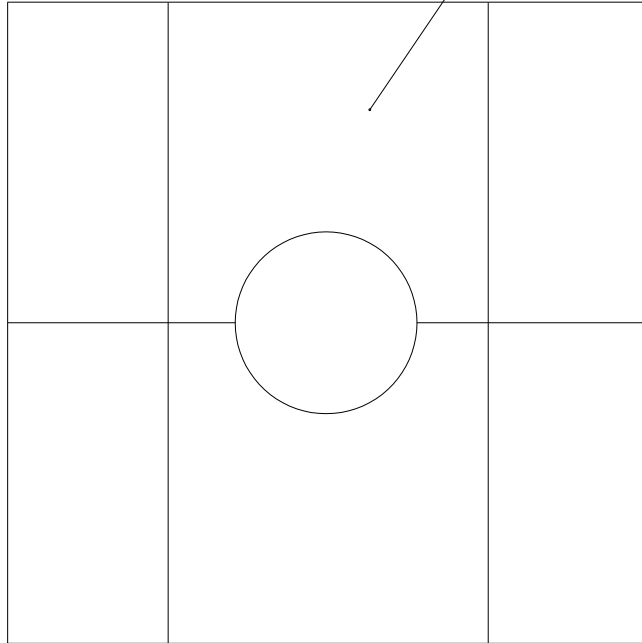
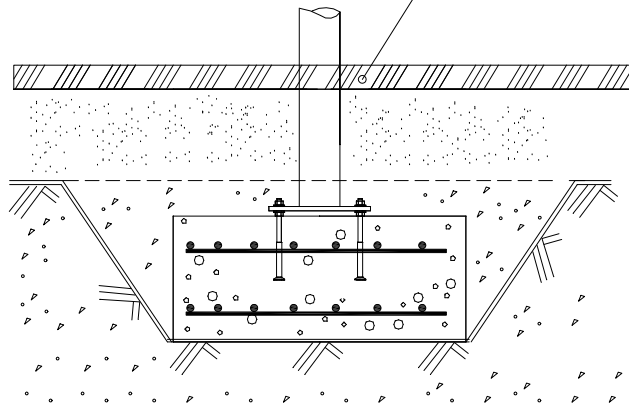



FINNO

ASENNUSOHJE
MONTERINGSANSVISNING
INSTALLATION INSTRUCTION
AUFBAUANLEITUNG
NOTICE D'INSTALLATION

DATE: 28.8.2018

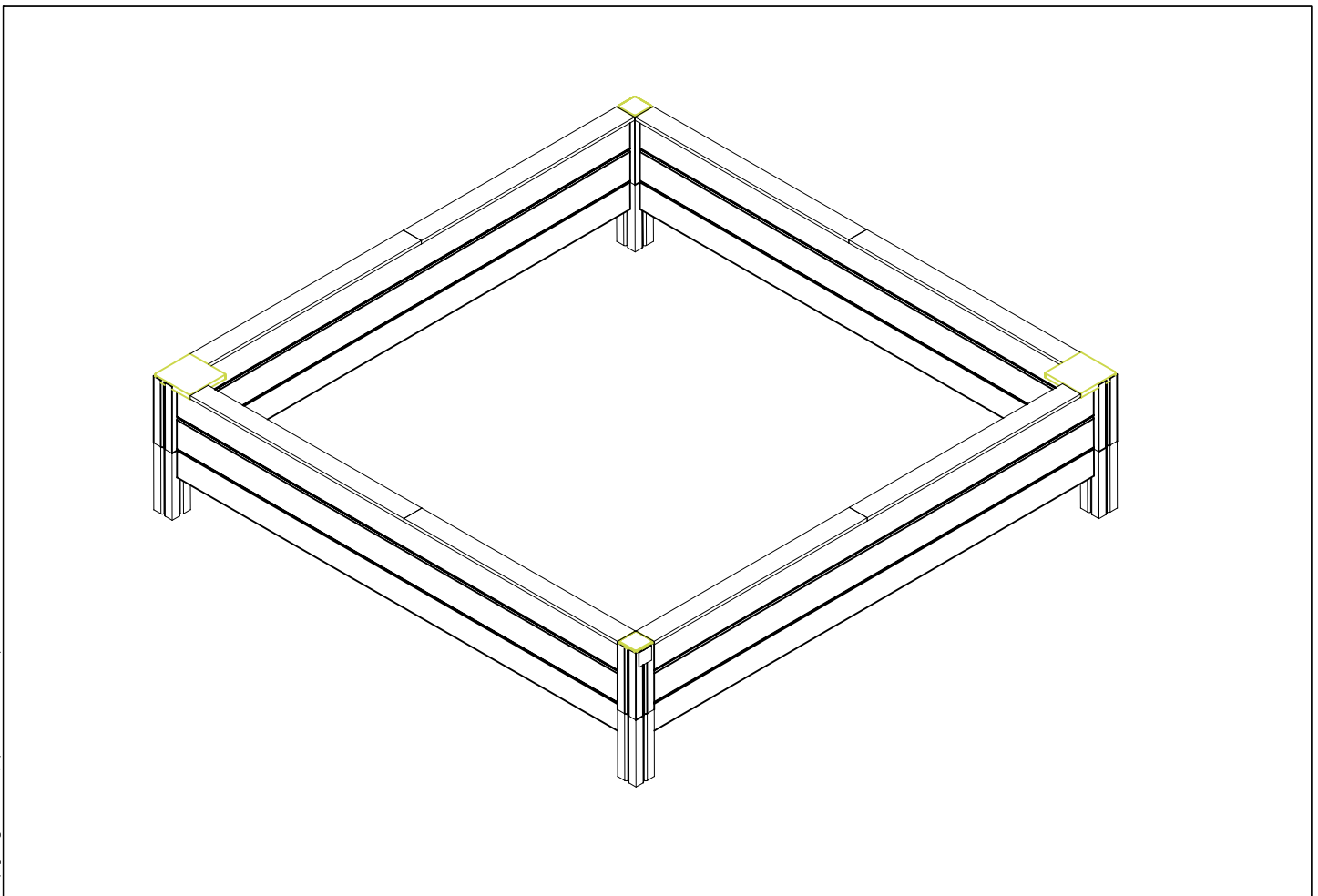
Q13173

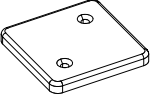
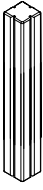
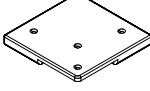
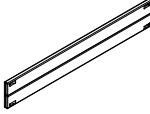
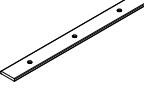
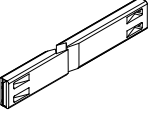
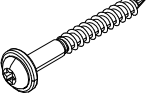
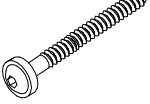
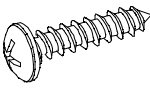
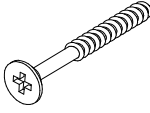

702286  65x65	PCS 1	706481-706483  83x83x10	PCS 2	706577-606579  93x93x600	PCS 4	706686-706688  45x290x2324	PCS 2	707273-607275  L 1105	PCS 4	707277  L 1105	PCS 8
707295-607297  L 2304	PCS 4	900240  Ø8x70	PCS 24	903093  Ø8x90	PCS 32	909506  Ø3.5x13	PCS 4	980107  Ø6x60	PCS 12		PCS
	PCS		PCS		PCS		PCS		PCS		PCS
	PCS		PCS		PCS		PCS		PCS		PCS
	PCS		PCS		PCS		PCS		PCS		PCS
	PCS		PCS		PCS		PCS		PCS		PCS
	PCS		PCS		PCS		PCS		PCS		PCS

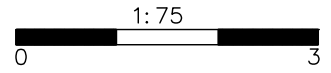

----- Falling Space 64.3 m²
Grid size = 1000mm

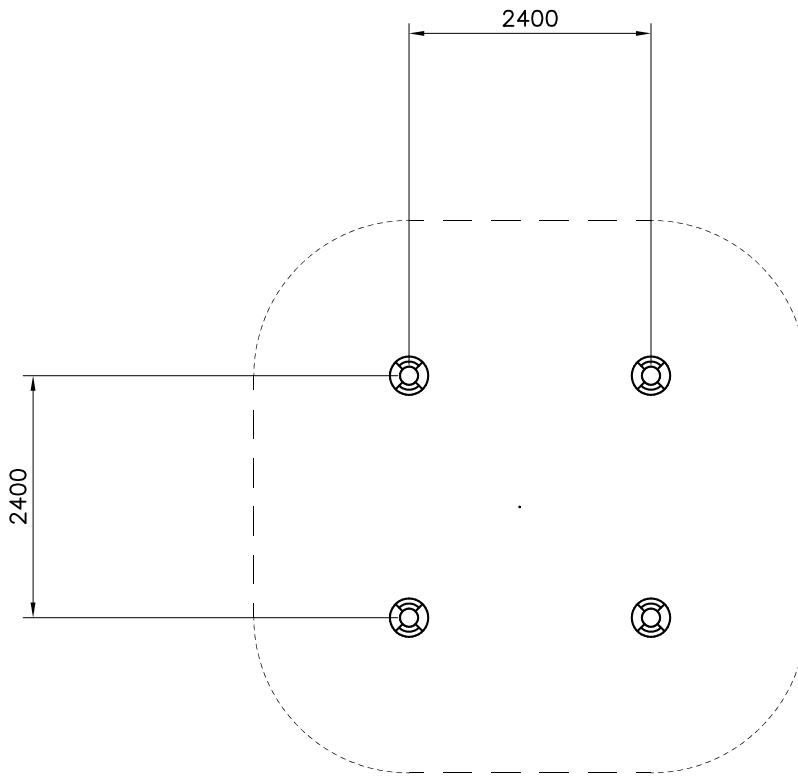

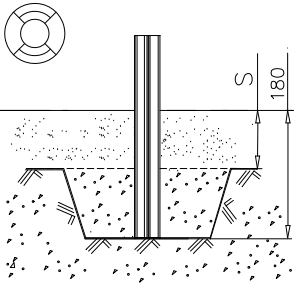

Falling Space 64.3 m²
Max Falling Height 420 mm

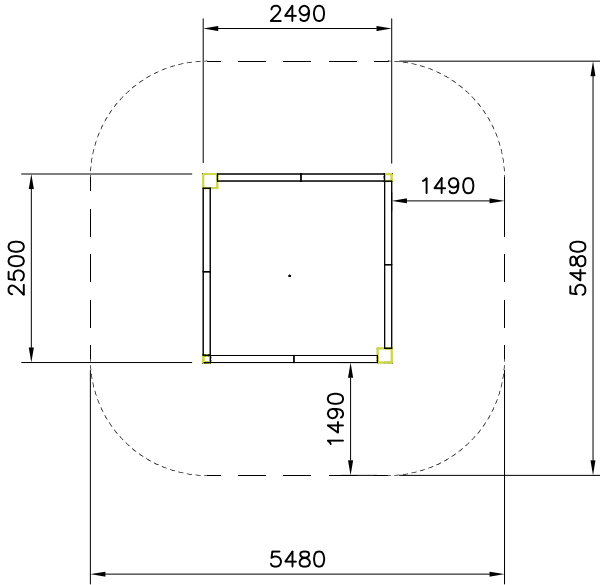
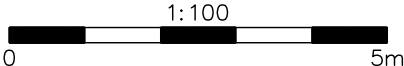

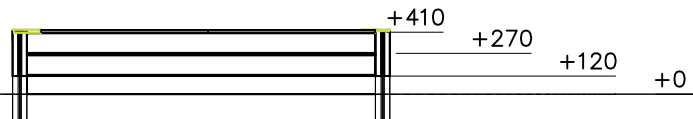
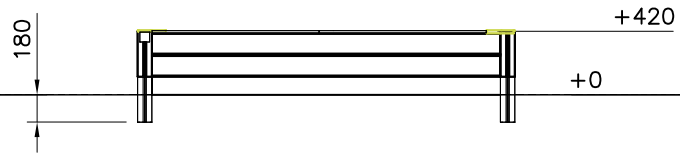

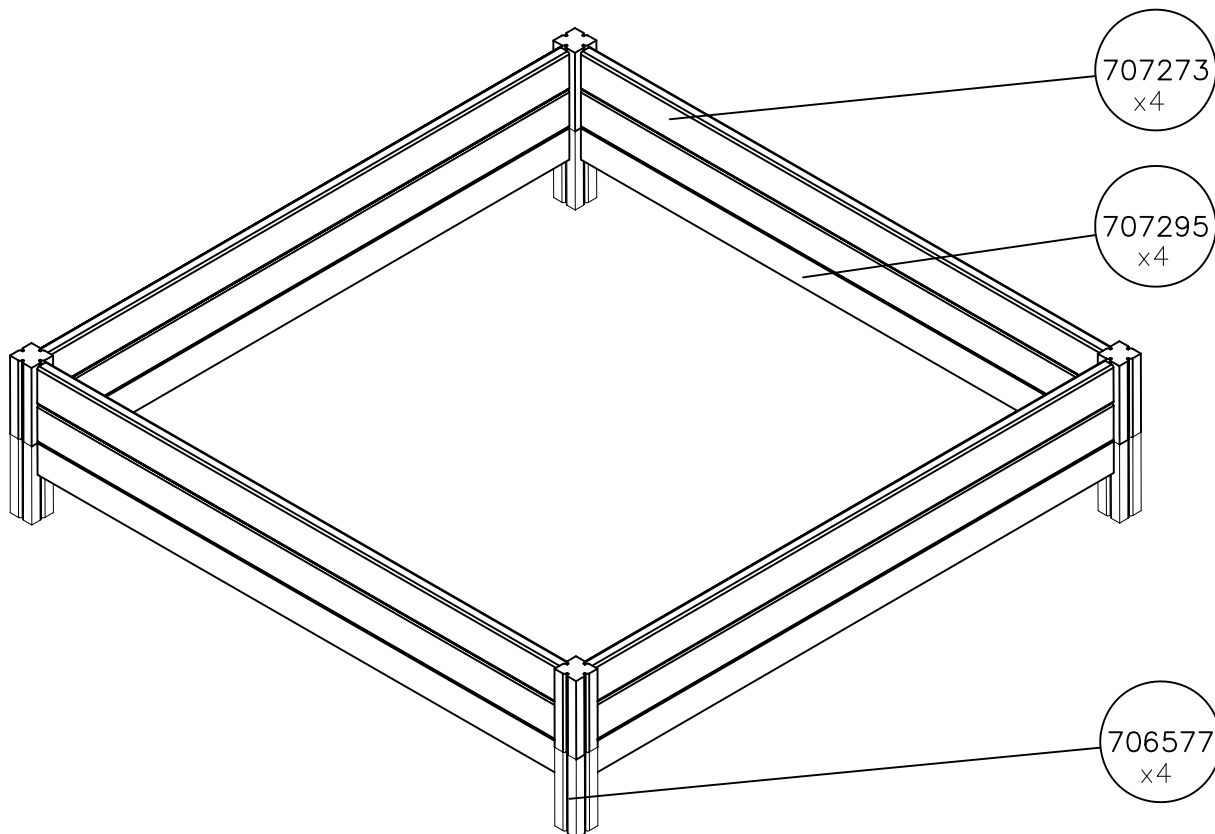
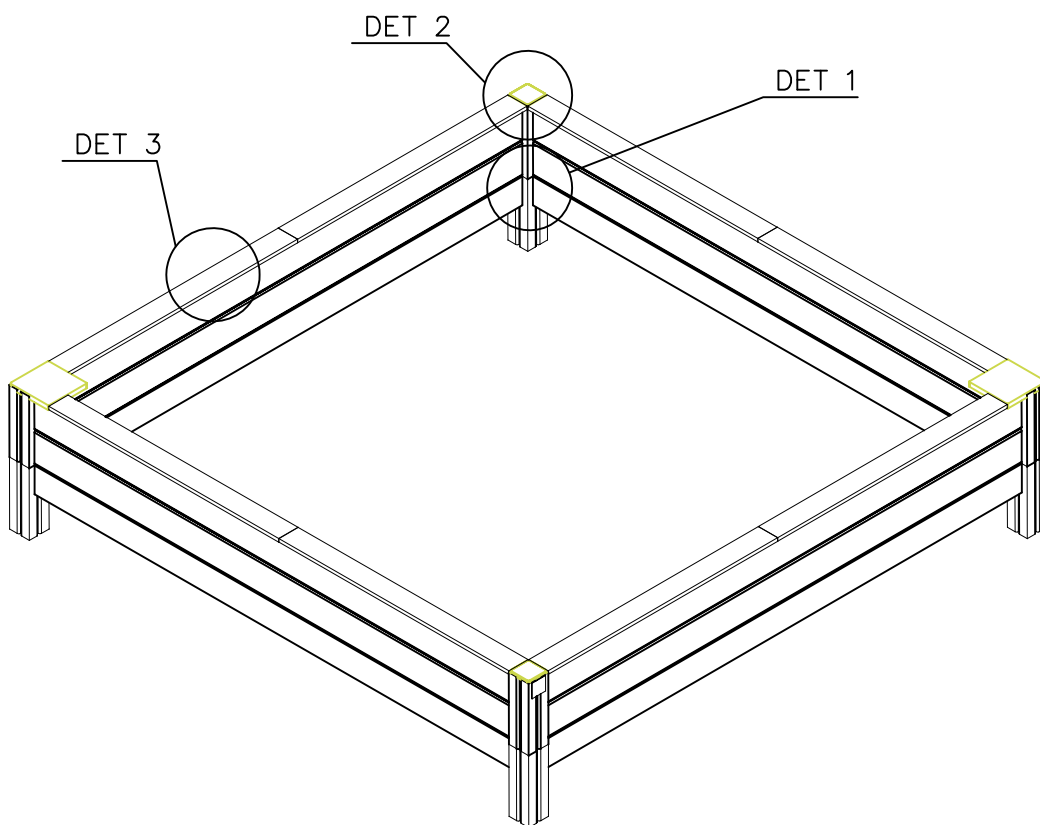

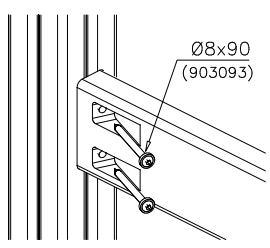
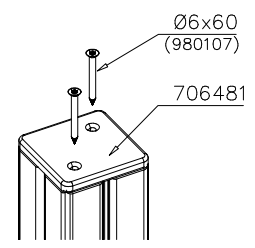
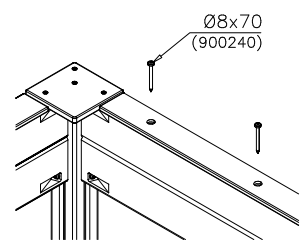
DET 1	DET 2	DET 3	
			

707277
x8

706481
x2

706686
x2

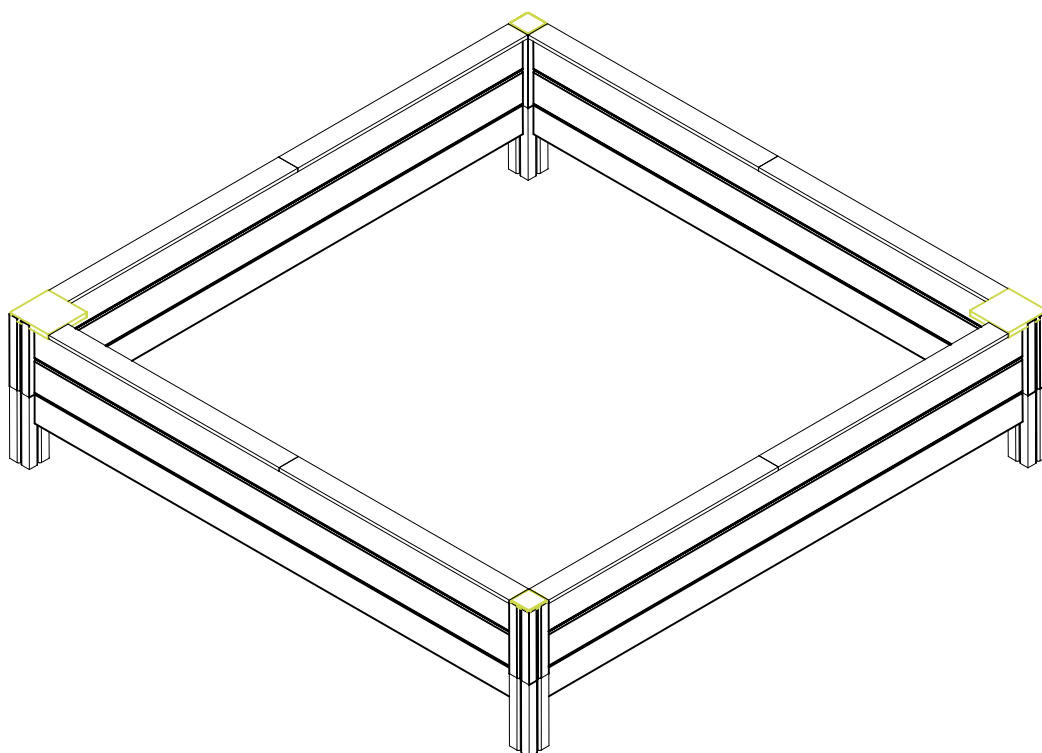
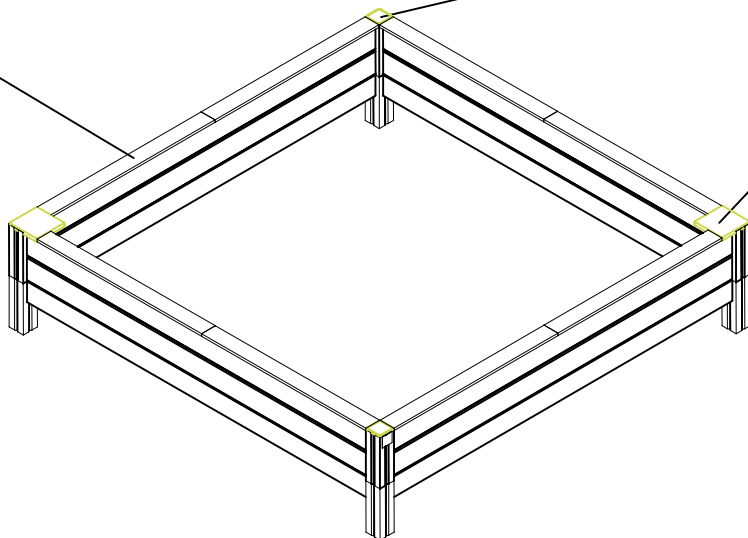

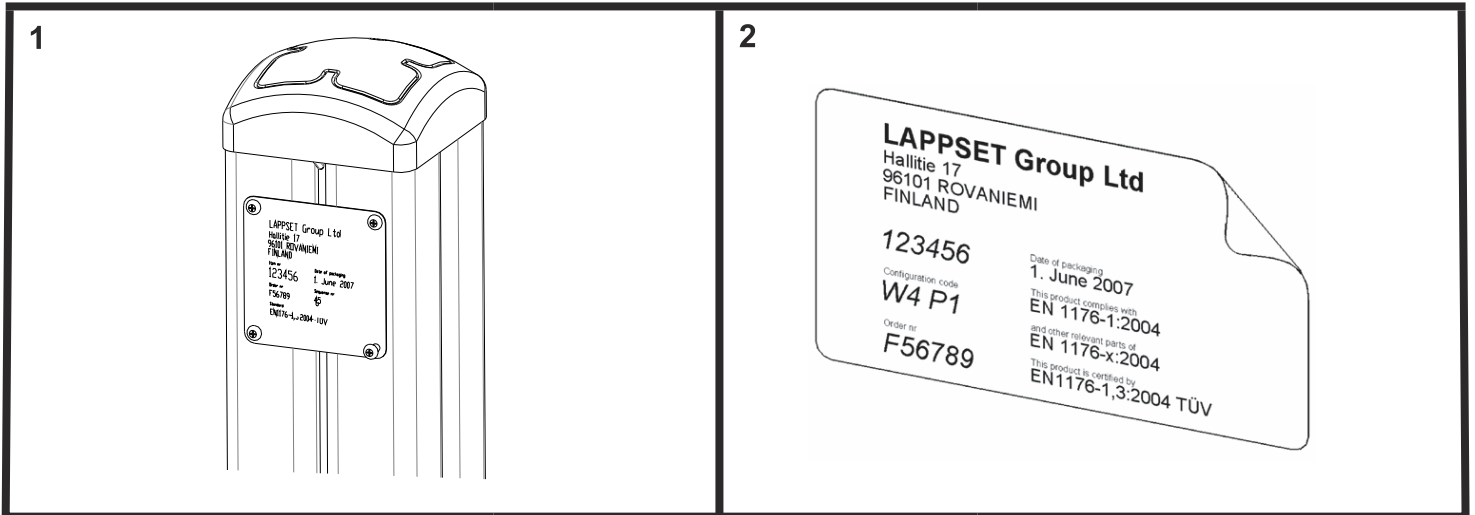
**Tuotekyltti tulee tuotteen mukana yhdellä seuraavista tavoista:****1) Metallinen tuotekyltti ja kiinnitysruuvit**

- Kiinnitä tuotekyltti ruuveilla tolppaan noin 2 metrin korkeuteen kuvan 1 mukaisesti.

2) Tuotekylttitarra

- Puhdista maalattu metalli- tai vaneripinta pölystä ja kosteudesta. Liimaa tarra kuvan 2 mukaisesti.
- Huom. Älä kiinnitä tarraa karheapintaiseen laminaattiin tai maalattuun puuhun.

Vår produktmärkning levereras på ett av följande sätt:**1) Produktskylt i metall**

- Fäst skylten med de medföljande skruvarna

2) Självhäftande produktetikett

- Rengör den pulverlackerade metallytan eller laminatyten så att den blir fri från smuts och fukt. Fäst etiketten enligt fig. 2.
- Obs! Fäst ej etiketten på detaljer med skrovlig yta eller på målat trä.

Product label is delivered by one of following ways:**1) Metal product label and screws**

- Fasten the label with screws.

2) Label sticker

- Clean the painted metal or plywood surface from dirt and moisture. Fasten the sticker as shown in the figure 2.
- Note. Do not attach the sticker to rough surfaced laminate or painted wood.

La plaque d'informations produit est livrée sous l'une de ces 3 formes :**1) Plaque métallique et vis**

- Fixez la plaque à l'aide des vis.

2) Etiquette autocollante

- Avant de coller l'étiquette, nettoyez le composant métallique peint ou la plaque de contreplaqué, de toute saleté. La surface doit être sèche (voir image 2).
- Attention, ne pas coller l'étiquette sur une surface lamellé-collée irrégulière ou sur du bois peint.

Die Auslieferung des Produktaufklebers erfolgt auf eine dieser Arten:**1) Produkt-Schild aus Metall incl. Schrauben**

- Die Befestigung des Schildes erfolgt mittels der Schrauben.

2) Aufkleber

- Entfernen Sie zunächst Schmutz und Feuchtigkeit vom lackierten Metall bzw. von der Holzoberfläche und bringen Sie den Aufkleber wie im Bild oben rechts beschrieben auf den gesäuberten Untergrund auf.
- Beachten Sie: Bringen Sie den Aufkleber nicht auf raues laminiertes oder lackiertes Holz an.