

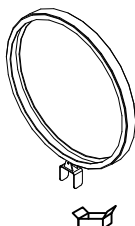

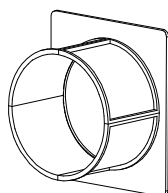

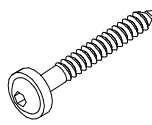

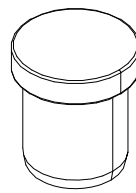

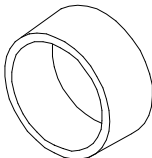
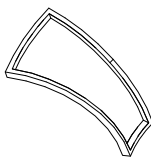
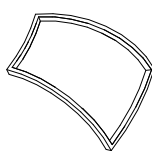
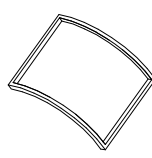
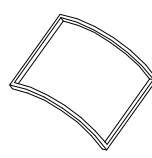

	PCS	004914	PCS	707918-705	PCS	900240	PCS	903533	PCS	905086	PCS
			1				14		6		4
						Ø8x70		SRL12		Ø44/13.5	
905112	PCS	905801	PCS	905811	PCS	905821	PCS	905829	PCS	905831	PCS
	528		6		6		10		10		456
BLACK Ø22		GREY		GREY		GREY		TRANSPARENT		BLACK	
905850	PCS	905859	PCS	905860	PCS	909205	PCS	909248	PCS	909274	PCS
	1		2		2		228		4		4
		6x80x850				8x60		M12		8x30	
980150	PCS	980151	PCS		PCS		PCS		PCS		PCS
	232		8								
M8		Ø16/8.4									
	PCS		PCS		PCS		PCS		PCS		PCS
	PCS		PCS		PCS		PCS		PCS		PCS

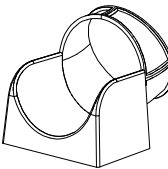

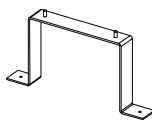
<p>905850</p>  <p>Access- and maintenance panel. Asennus- ja huolto luukku.</p>	<p>905850 SURFACE MOUNT OPTION</p> 	<p>905850</p> 
<p>905850</p> 	<p>905850</p> 	<p>905850</p> 



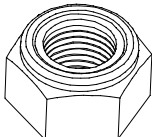
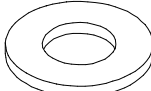
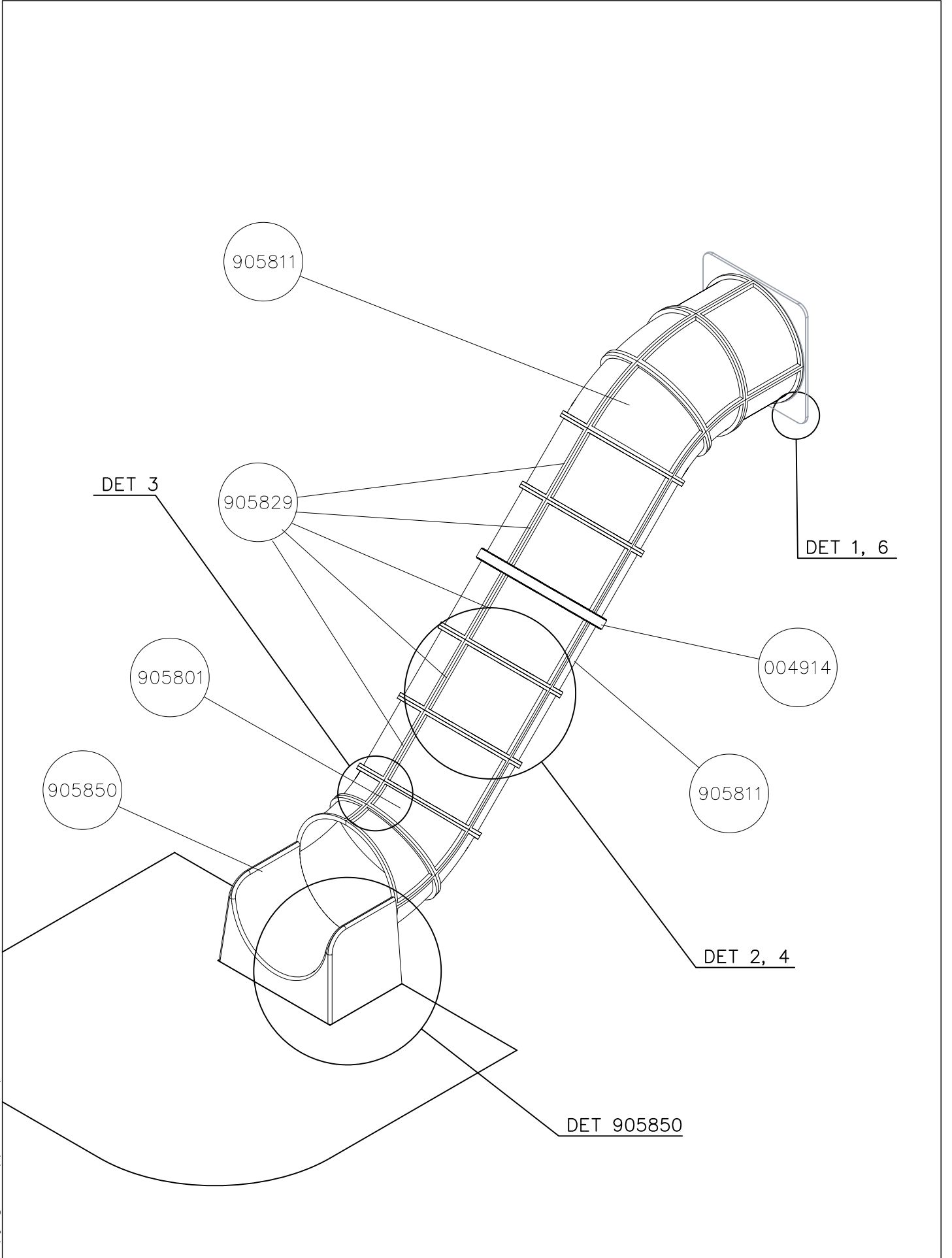
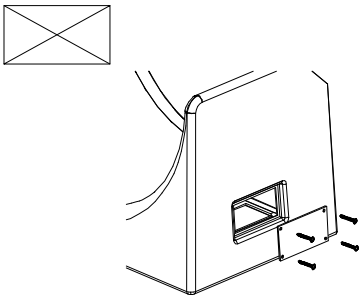
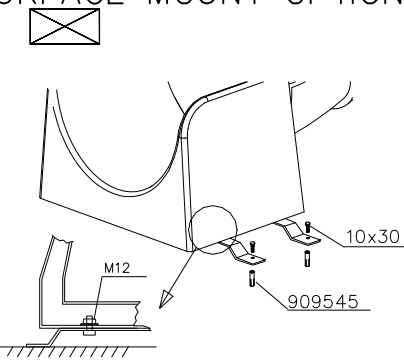
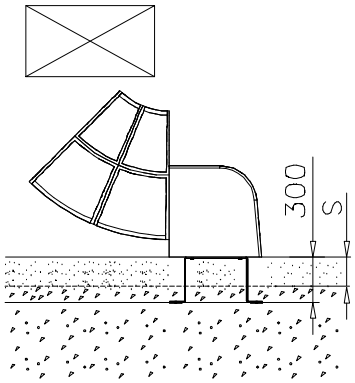
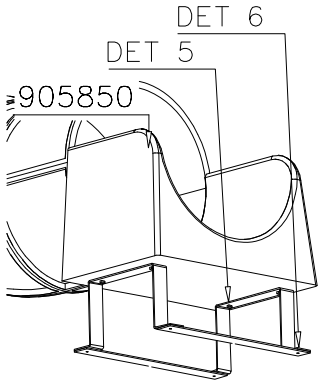
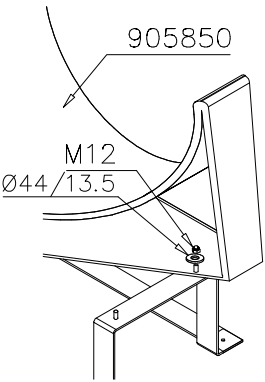
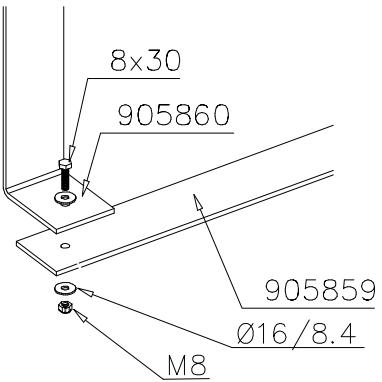
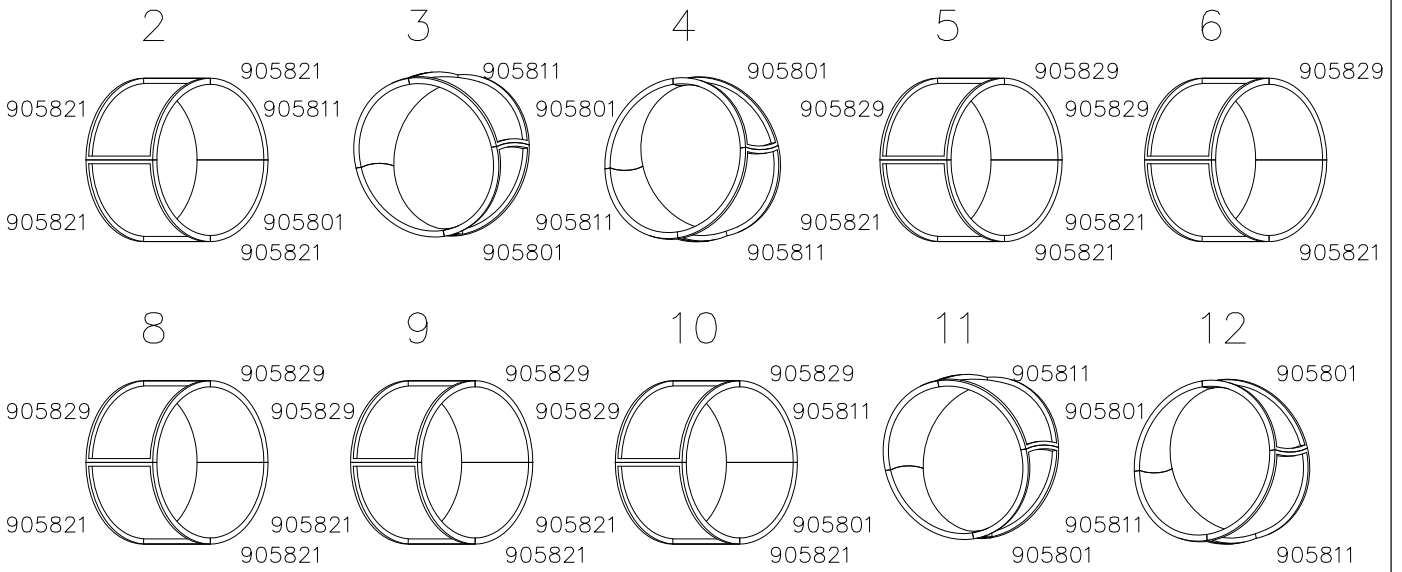





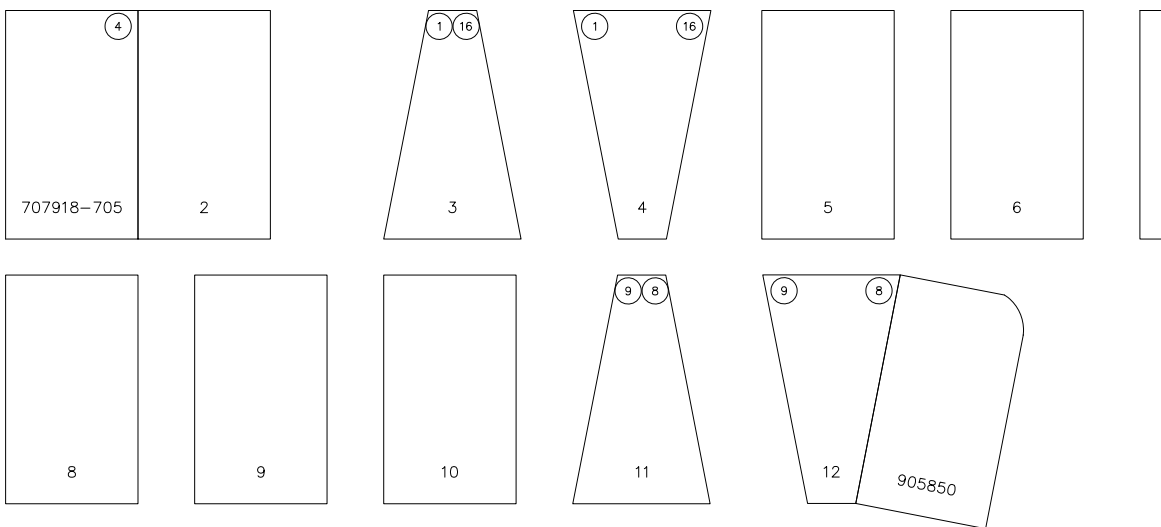
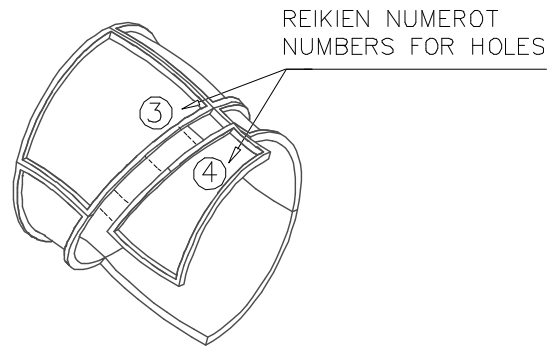



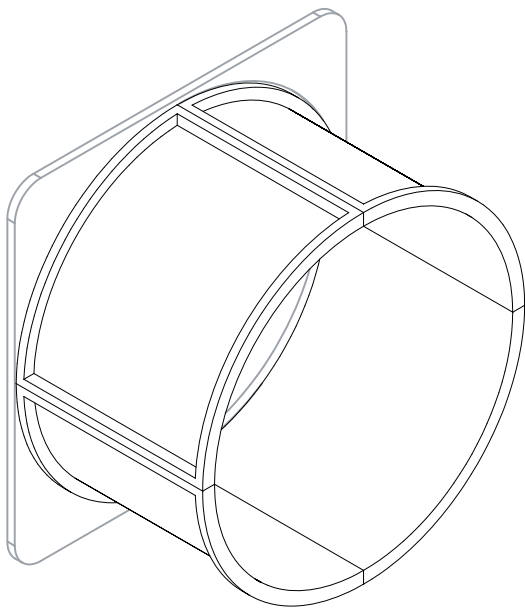
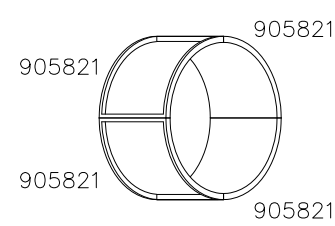
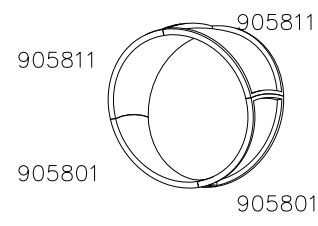



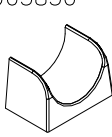





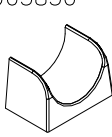







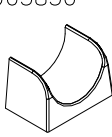









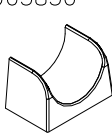

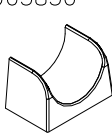

Esimerkki putken kokoamisesta
Example of installation

LIUKUPINTAAN EI SAA TULLA
LÄPINÄKYVIÄ MODUULEJA!!

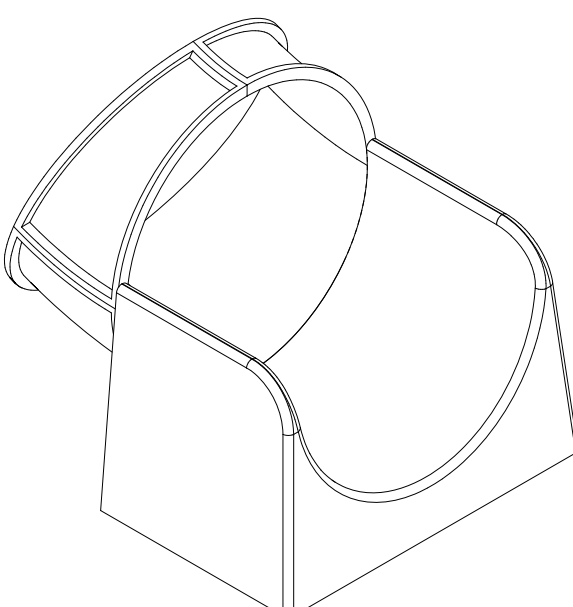
NO TRANSPARENT PIECES ON
SLIDING SURFACE!!

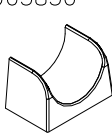

Valmiiksi kasattujen osien osakokoonpanot ja vara-osa listat.
Ready installed component subassemblies and spare part list.

	<p style="text-align: center;">2</p> 								
<p style="text-align: center;">12</p>  <table border="1" data-bbox="159 1724 734 2105"> <tr> <td>909205 x 16 909206 x 8 </td> <td>980150 x 16 </td> <td>905831 x 32 </td> </tr> <tr> <td>905850 </td> <td>909208 x 8 </td> <td>980151 x 8 </td> </tr> </table>	909205 x 16 909206 x 8 	980150 x 16 	905831 x 32 	905850 	909208 x 8 	980151 x 8 	<p>707918-705 x 4 </p>	<p>909205 x 12 </p>	<p>980150 x 12 </p>
909205 x 16 909206 x 8 	980150 x 16 	905831 x 32 							
905850 	909208 x 8 	980151 x 8 							
<p>909252 x 13 </p>	<p>700413 x 1 </p>	<p>905831 x 40 </p>	<p>909208 x 16 </p>	<p>909119 x 16 </p>					
<table border="1" data-bbox="159 1724 734 2105"> <tr> <td>909205 x 16 909206 x 8 </td> <td>980150 x 16 </td> <td>905831 x 32 </td> </tr> <tr> <td>905850 </td> <td>909208 x 8 </td> <td>980151 x 8 </td> </tr> </table>			909205 x 16 909206 x 8 	980150 x 16 	905831 x 32 	905850 	909208 x 8 	980151 x 8 	 <p style="text-align: center;">Position of the box: 90 degrees</p>
909205 x 16 909206 x 8 	980150 x 16 	905831 x 32 							
905850 	909208 x 8 	980151 x 8 							

DET 1



DET 2



DET 3



DET 4

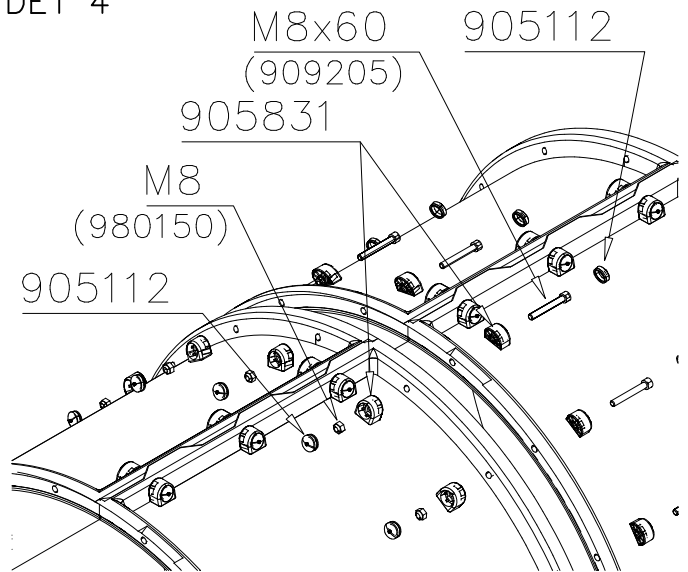

DET 5



DET 6





Tuotekyltti tulee tuotteen mukana yhdellä seuraavista tavoista:

1) Metallinen tuotekyltti ja kiinnitysruuvit

- Kiinnitä tuotekyltti ruuveilla tolppaan noin 2 metrin korkeuteen kuvan 1 mukaisesti.

2) Tuotekylttitarra

- Puhdista maalattu metalli- tai vaneripinta pölystä ja kosteudesta. Liimaa tarra kuvan 2 mukaisesti.
- Huom. Älä kiinnitä tarraa karheapintaiseen laminaattiin tai maalattuun puuhun.

Vår produktmärkning levereras på ett av följande sätt:

1) Produktskylt i metall

- Fäst skylten med de medföljande skruvarna

2) Självhäftande produktetikett

- Rengör den pulverlackerade metallytan eller laminatyten så att den blir fri från smuts och fukt. Fäst etiketten enligt fig. 2.
- Obs! Fäst ej etiketten på detaljer med skrovlig yta eller på målat trä.

Product label is delivered by one of following ways:

1) Metal product label and screws

- Fasten the label with screws.

2) Label sticker

- Clean the painted metal or plywood surface from dirt and moisture. Fasten the sticker as shown in the figure 2.
- Note. Do not attach the sticker to rough surfaced laminate or painted wood.

La plaque d'informations produit est livrée sous l'une de ces 3 formes :

1) Plaque métallique et vis

- Fixez la plaque à l'aide des vis.

2) Etiquette autocollante

- Avant de coller l'étiquette, nettoyez le composant métallique peint ou la plaque de contreplaqué, de toute saleté. La surface doit être sèche (voir image 2).
- Attention, ne pas coller l'étiquette sur une surface lamellé-collée irrégulière ou sur du bois peint.

Die Auslieferung des Produktaufklebers erfolgt auf eine dieser Arten:

1) Produkt-Schild aus Metall incl. Schrauben

- Die Befestigung des Schildes erfolgt mittels der Schrauben.

2) Aufkleber

- Entfernen Sie zunächst Schmutz und Feuchtigkeit vom lackierten Metall bzw. von der Holzoberfläche und bringen Sie den Aufkleber wie im Bild oben rechts beschrieben auf den gesäuberten Untergrund auf.
- Beachten Sie: Bringen Sie den Aufkleber nicht auf raues laminiertes oder lackiertes Holz an.

LAPPSET®
BETON FOUNDATION

FOOT

DATE: 27.10.2015





1(1)

② 905104	PCS		PCS
	4		
 M10	PCS		PCS

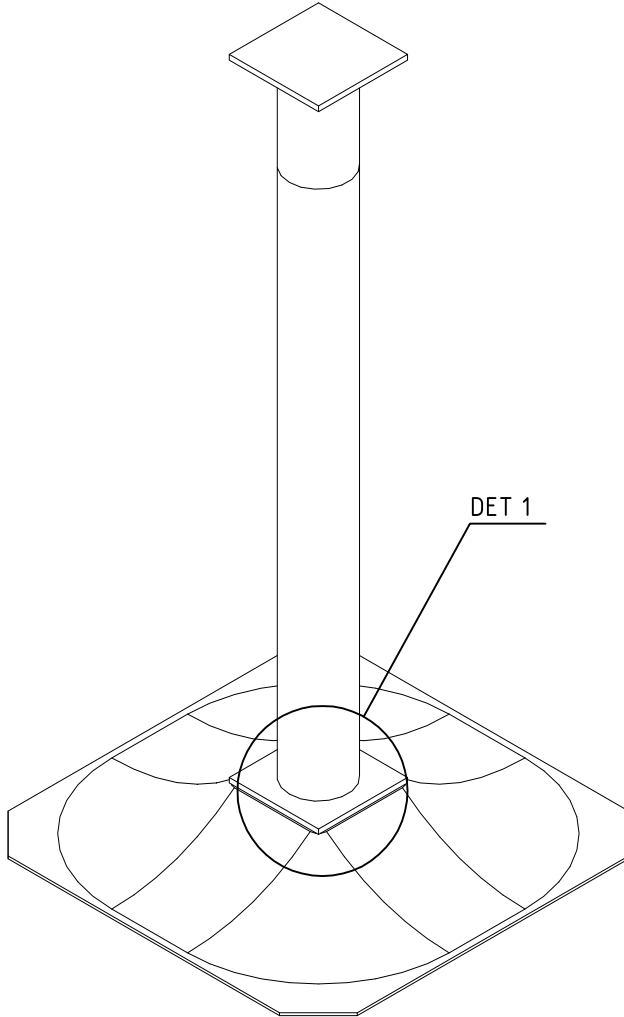

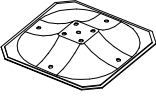
905104



①	909511	PCS	②	909519	PCS
		1			1
③	909637	PCS	④	909638	PCS
		4			8
	M10			Ø20/10.5	
⑤	909639	PCS			PCS
		4			
	M10x25				
		PCS			PCS
		PCS			PCS
		PCS			PCS
		PCS			PCS

DET 1

