

# **LAPPSET®**

## **PROMENADE**







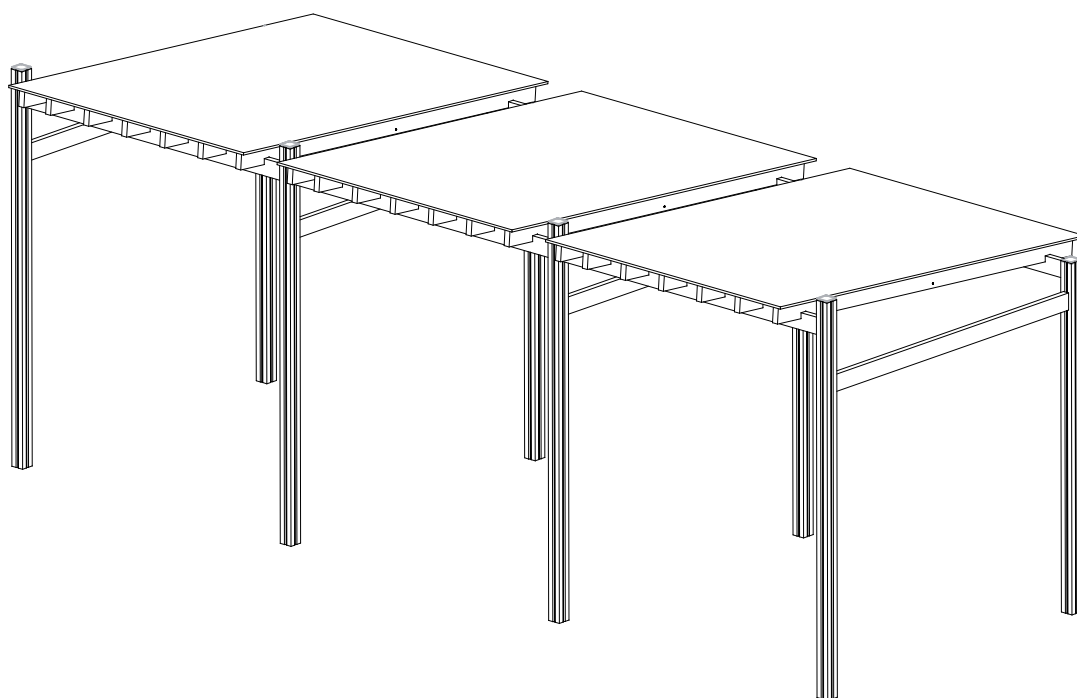

ASENNUSOHJE  
MONTERINGSANSVISNING  
INSTALLATION INSTRUCTION  
AUFBAUANLEITUNG  
NOTICE D'INSTALLATION

DATE: 6.4.2018

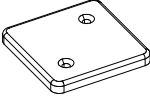
### **Q11749**

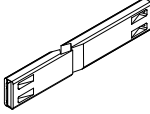
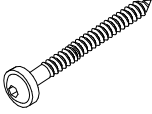
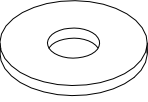
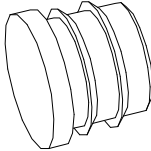

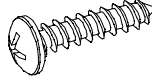
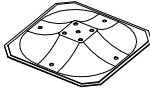
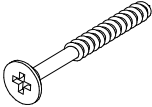
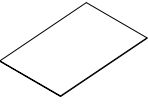
DATE: 6.4.2018

702286  65x65	PCS 1	706444-604  93x93x3200	PCS 4	706481-705  83x83x10	PCS 8	706568-604  93x93x3000	PCS 4	707295-604  L 2304	PCS 10	903093  Ø8x90	PCS 40
905051  Ø24/8.4	PCS 42	905066  S30H	PCS 42	909232  8x120	PCS 42	909506  Ø3.5x13	PCS 4	909519  50x380x380	PCS 8	980107  Ø6x60	PCS 16
P05117  16x2100x3000	PCS 3	P10563-604  L 2900	PCS 21		PCS		PCS		PCS		PCS
	PCS		PCS		PCS		PCS		PCS		PCS
	PCS		PCS		PCS		PCS		PCS		PCS
	PCS		PCS		PCS		PCS		PCS		PCS
	PCS		PCS		PCS		PCS		PCS		PCS

—— EN/AS Impact Area 44.9 m<sup>2</sup>

- - - - Falling Space 44.9 m<sup>2</sup>

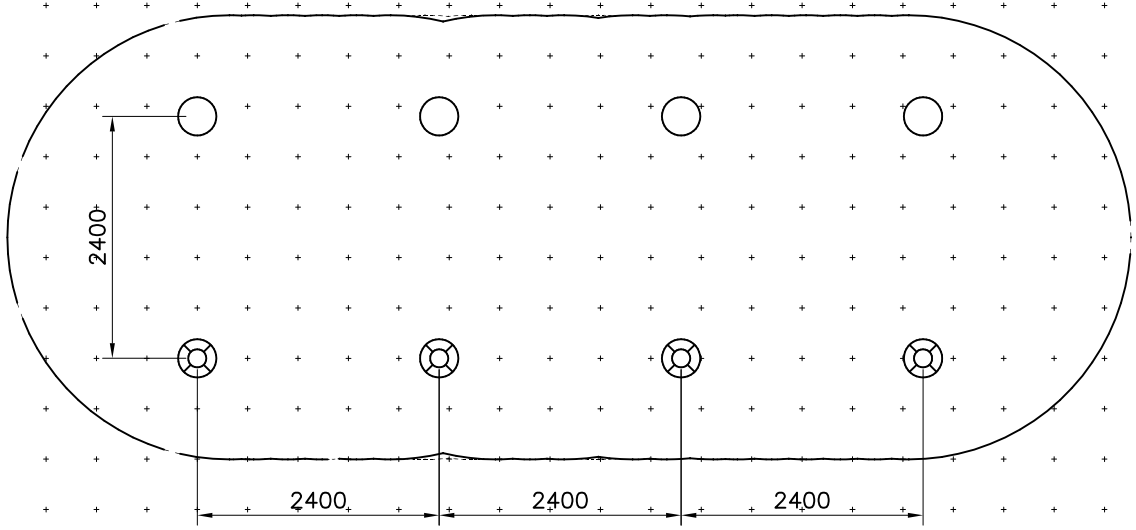
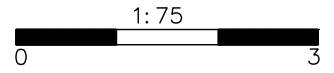

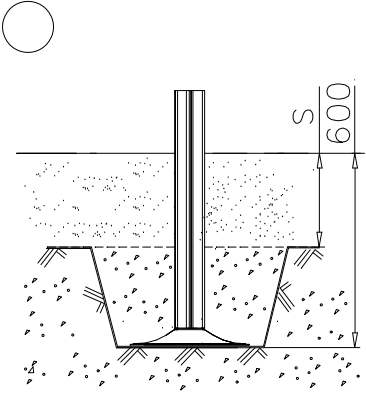
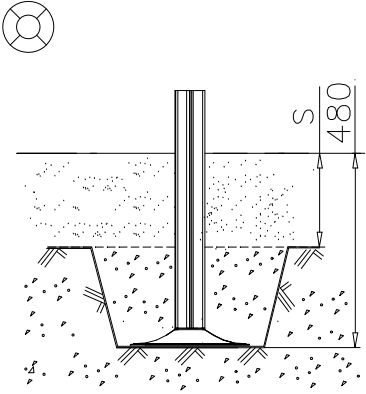
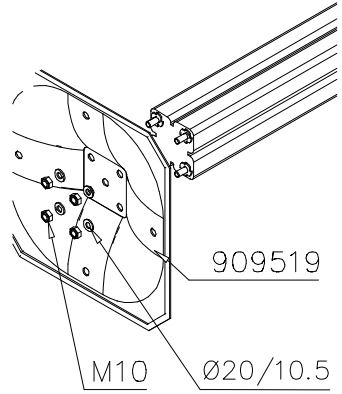

—— EN/AS Impact Area 44.9 m<sup>2</sup>

----- Falling Space 44.9 m<sup>2</sup>

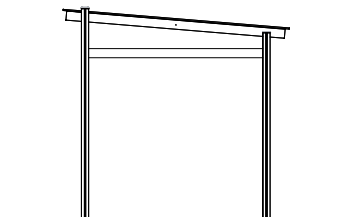
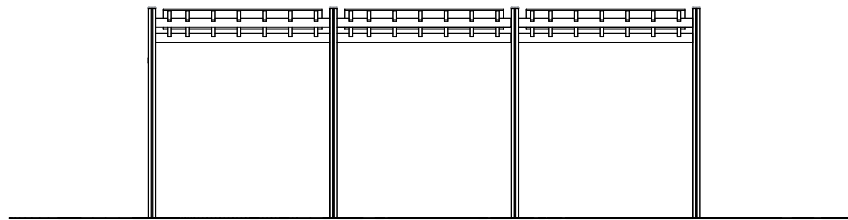
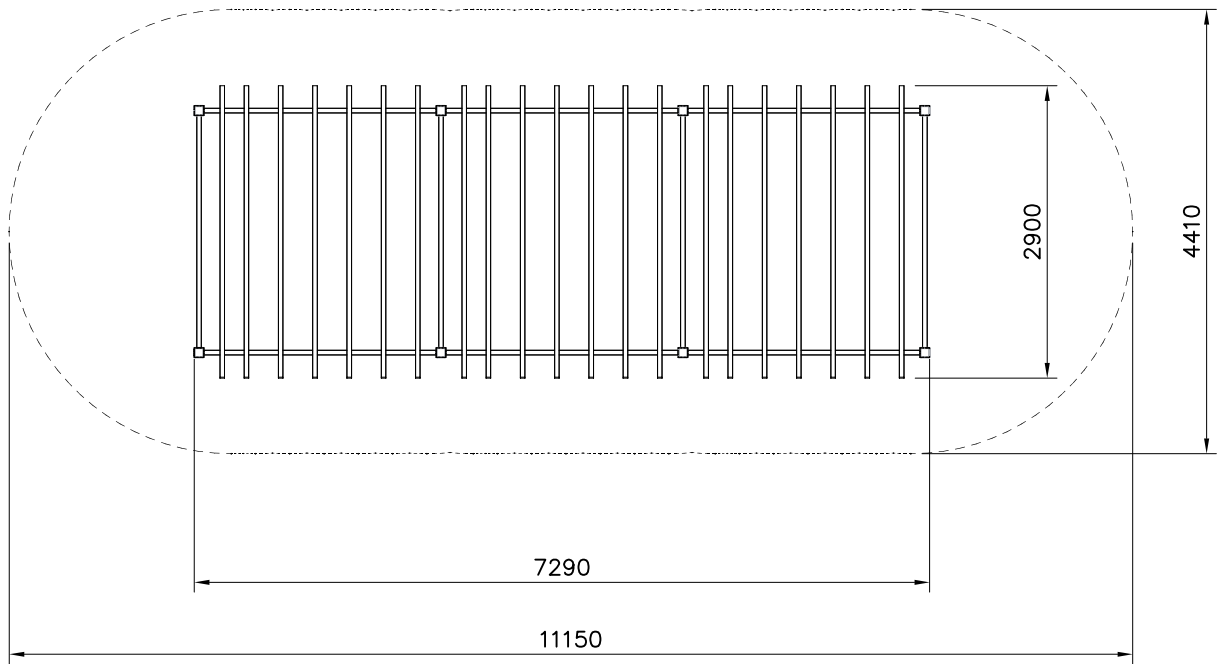
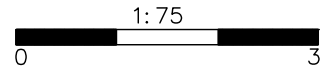

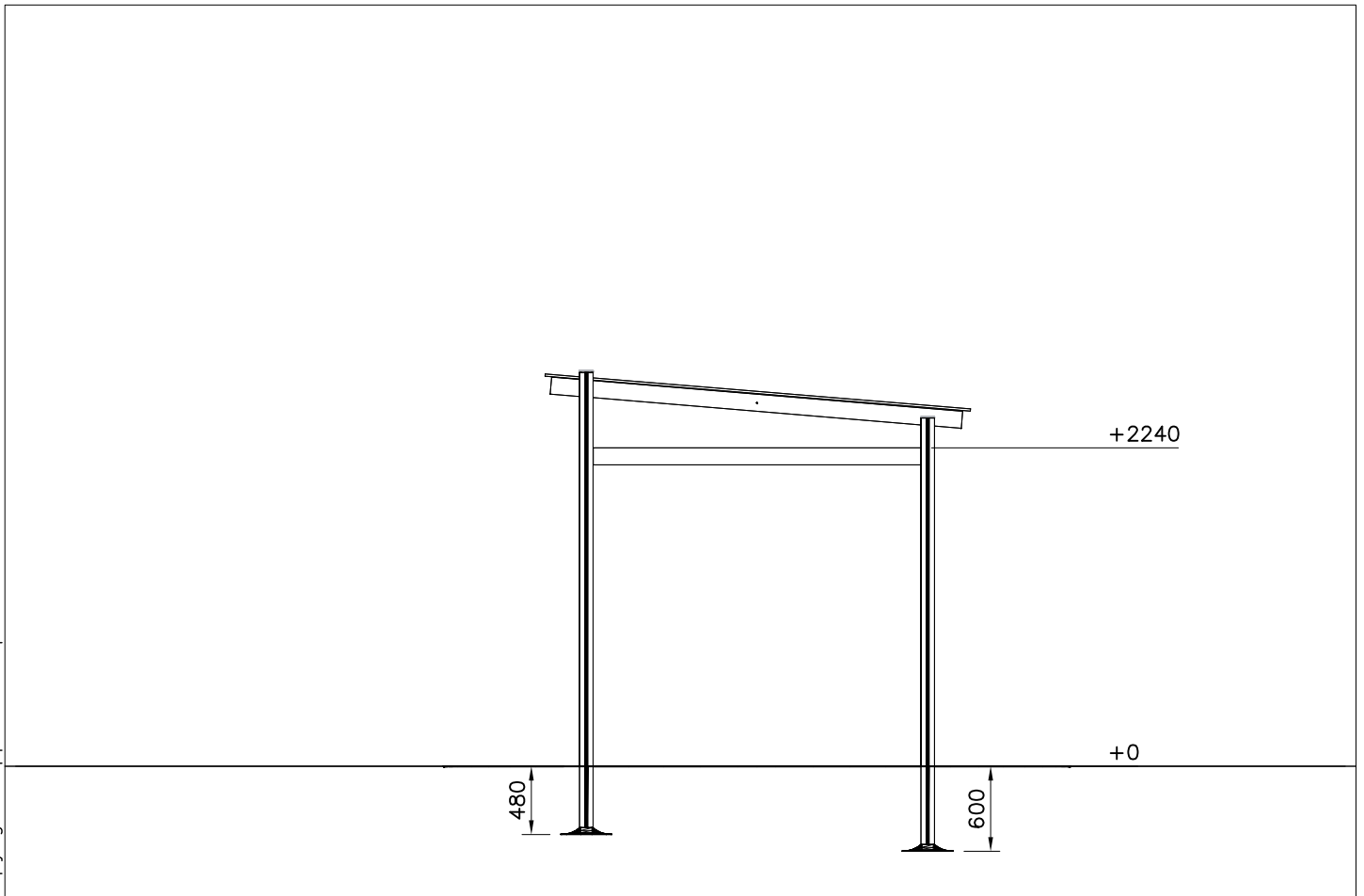
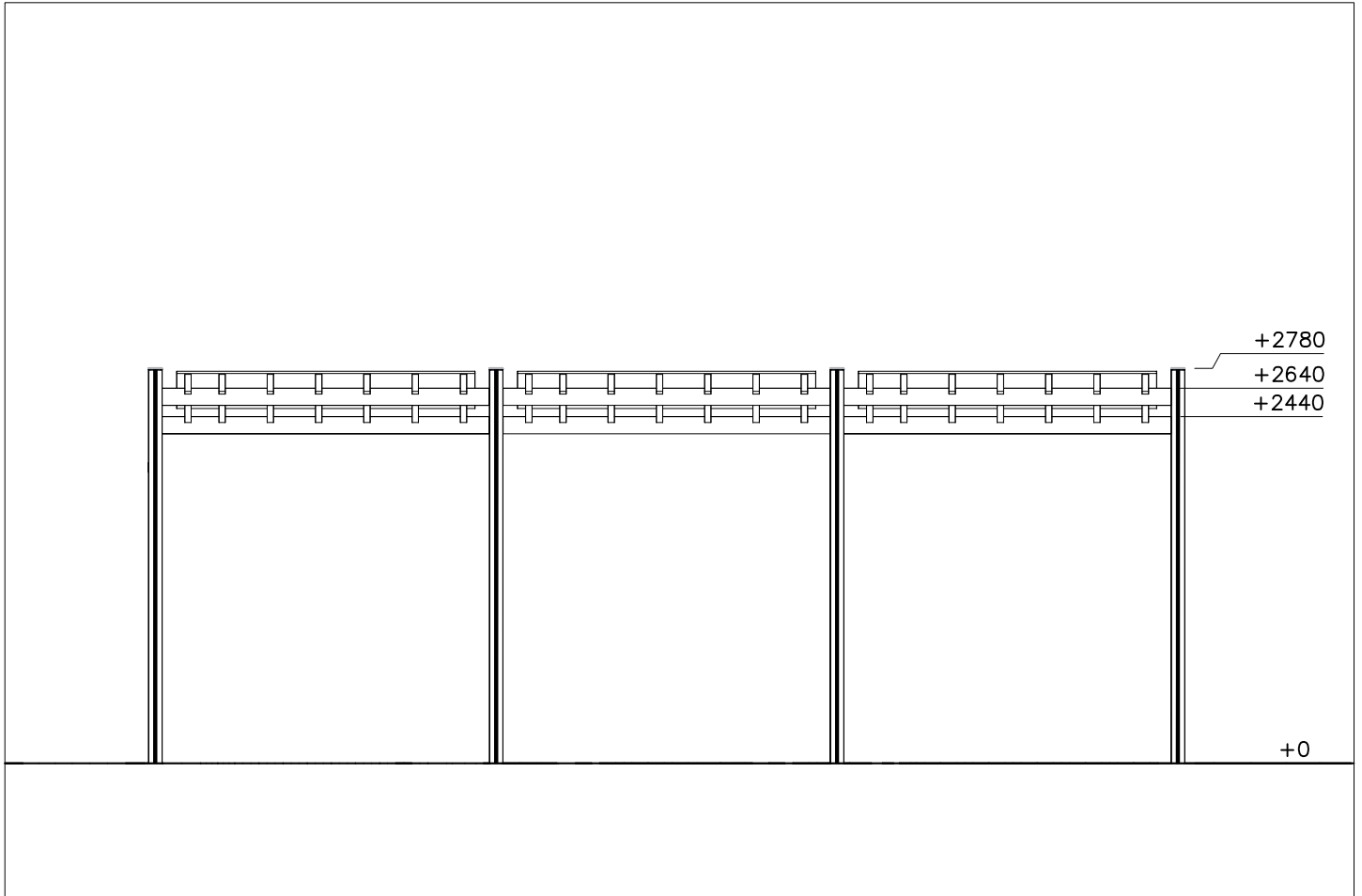

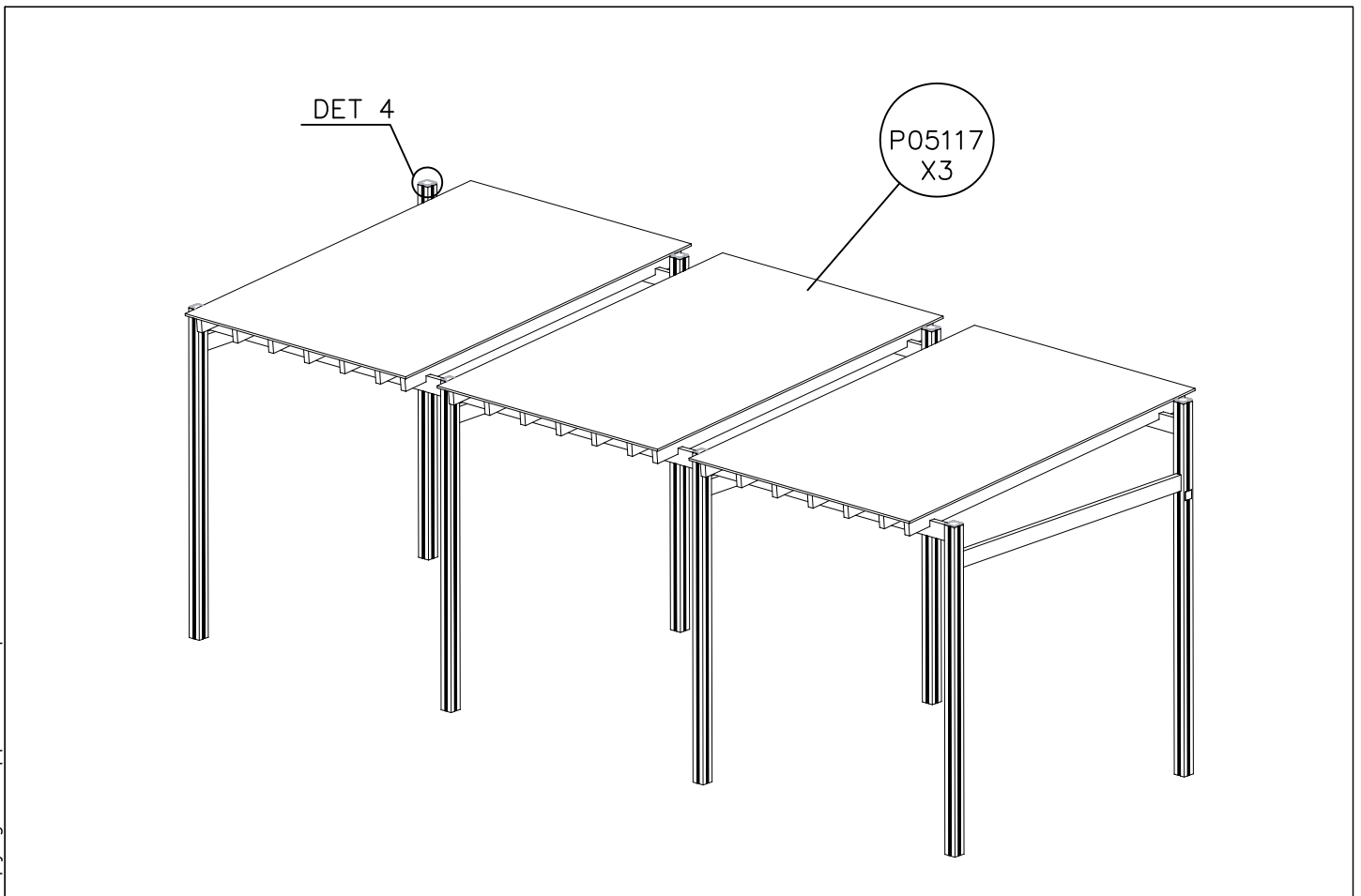
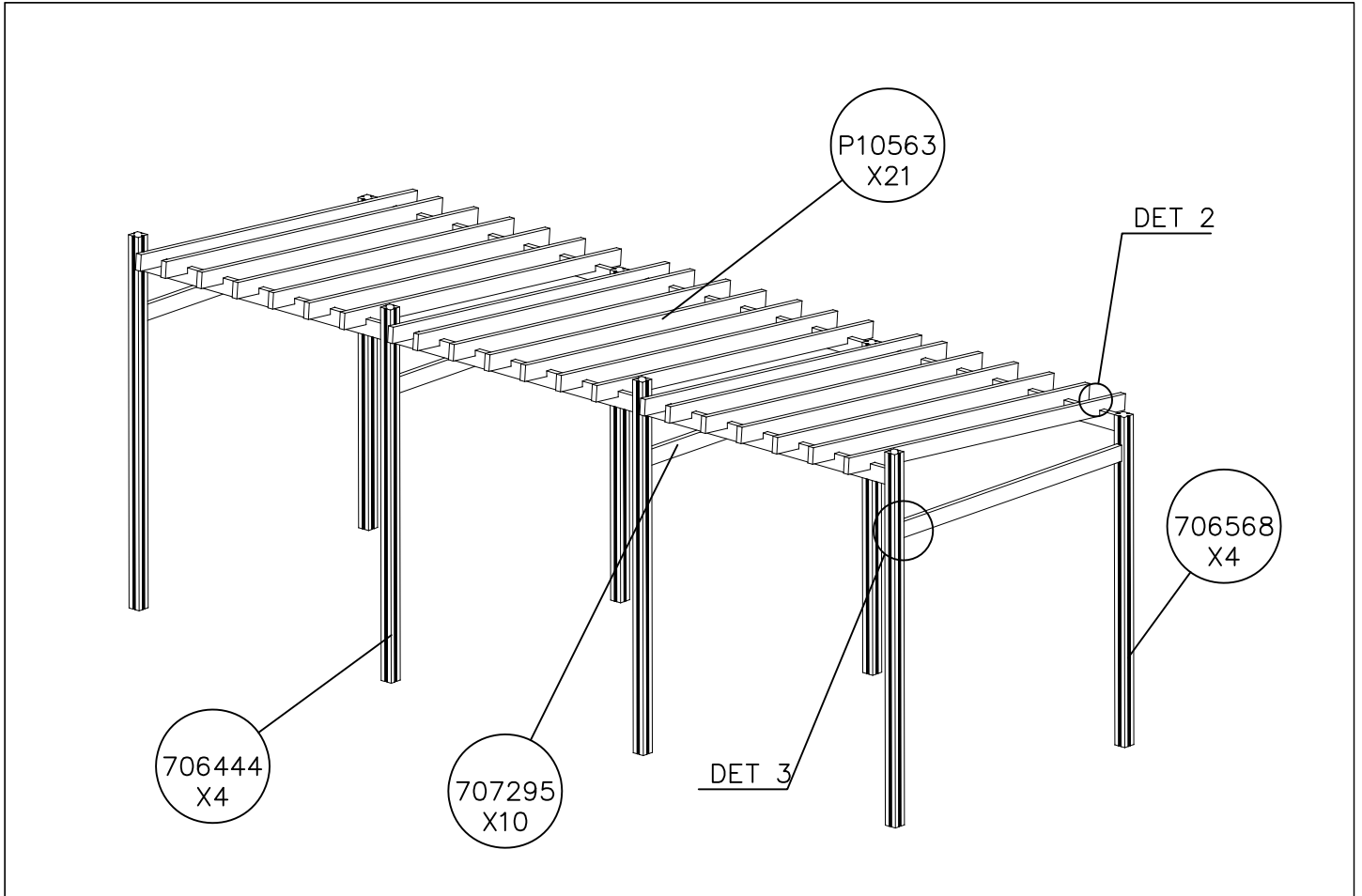

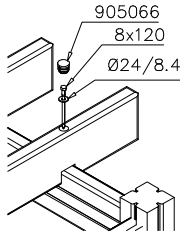
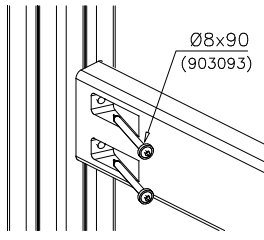
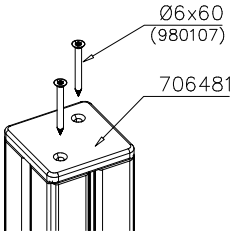
	DET 2 	DET 3 	DET 4 



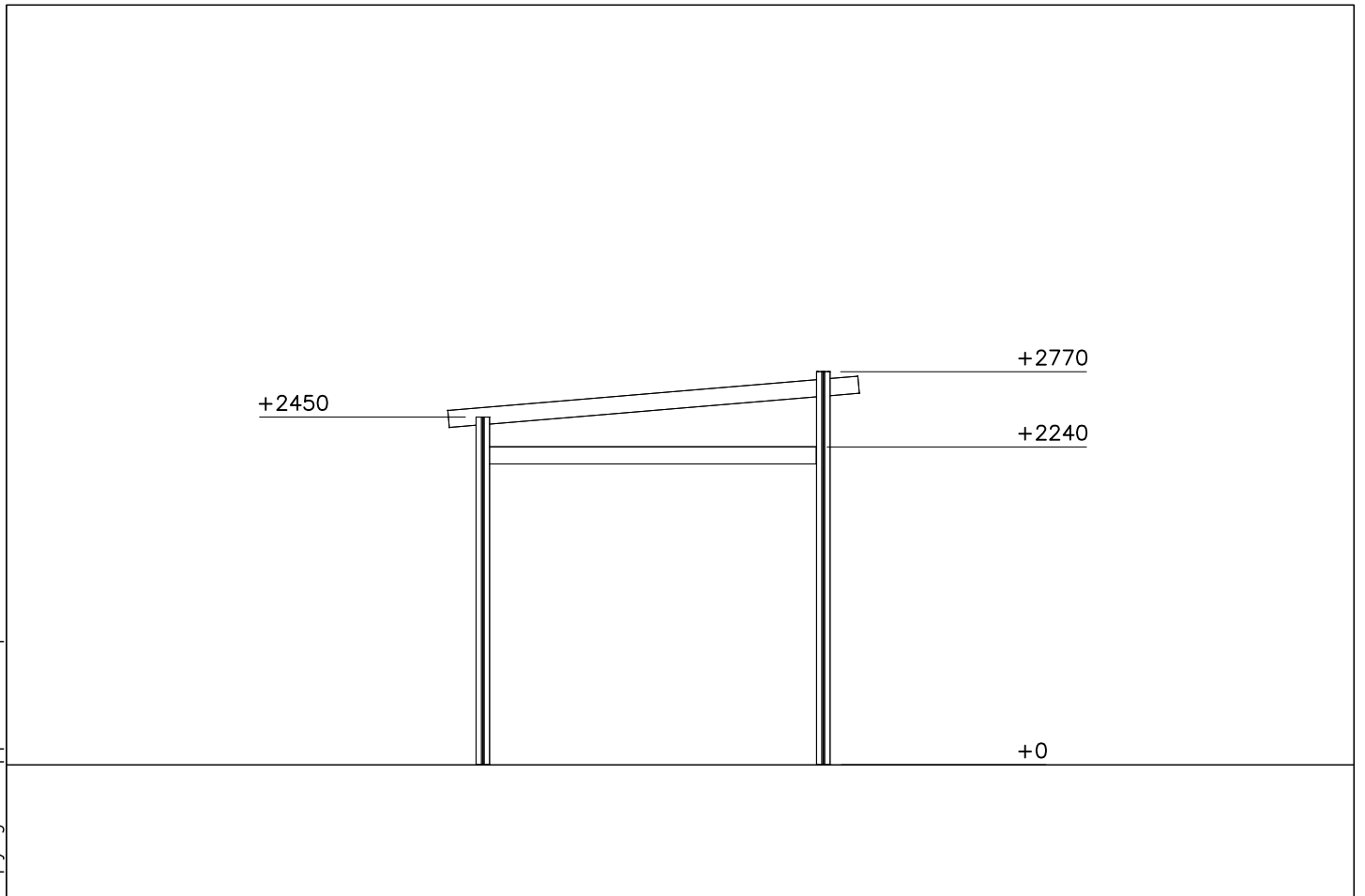
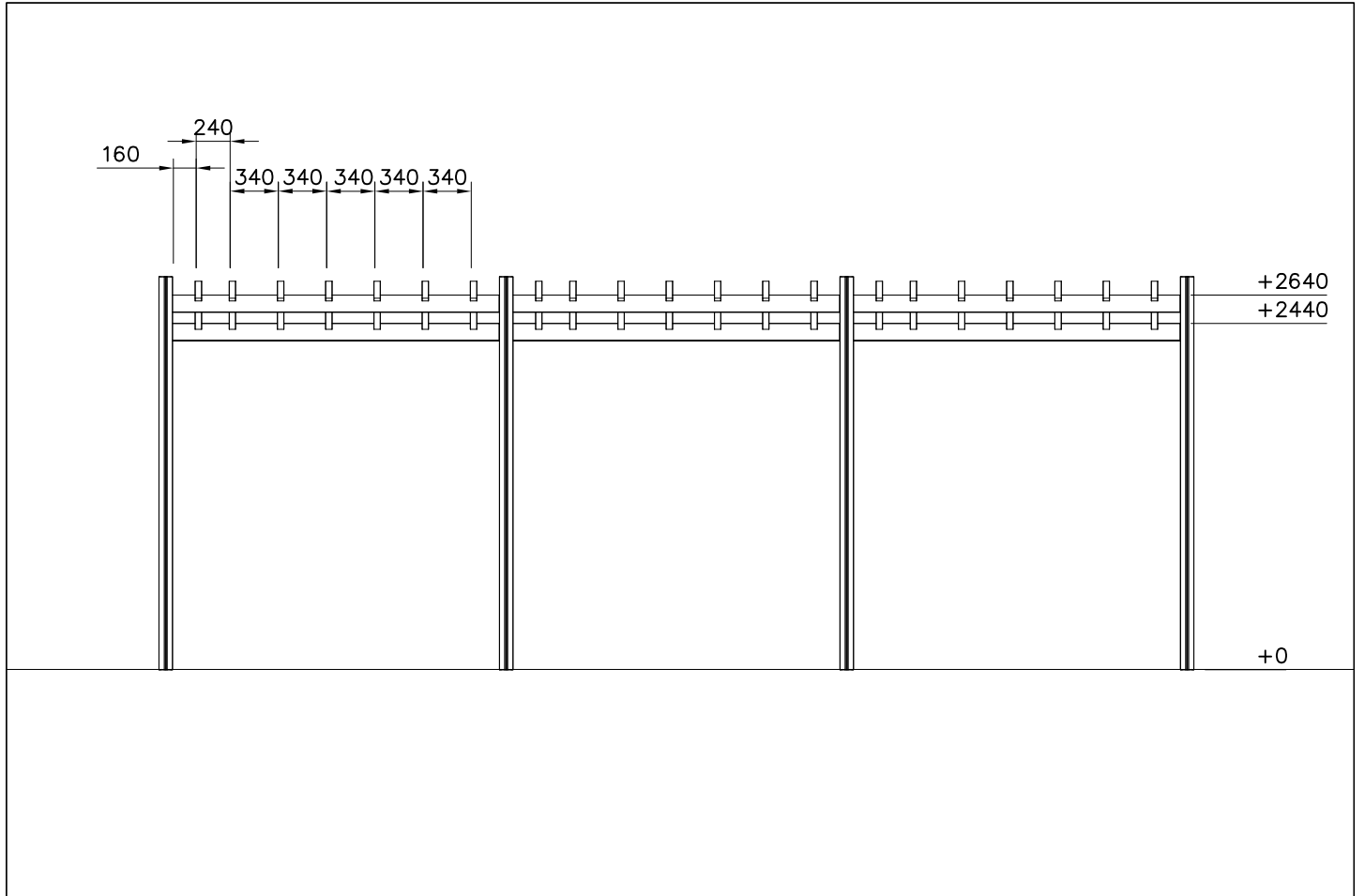

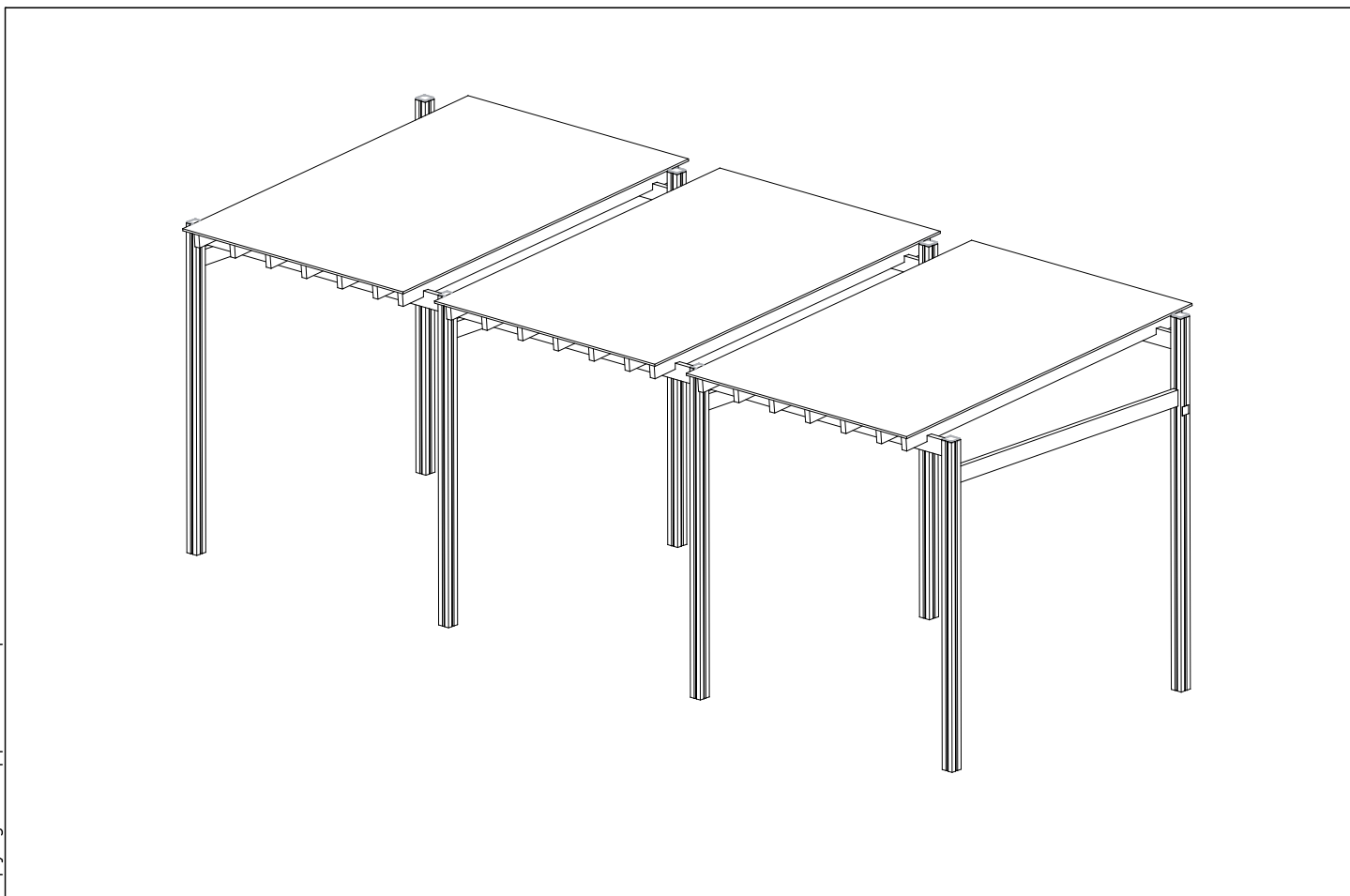
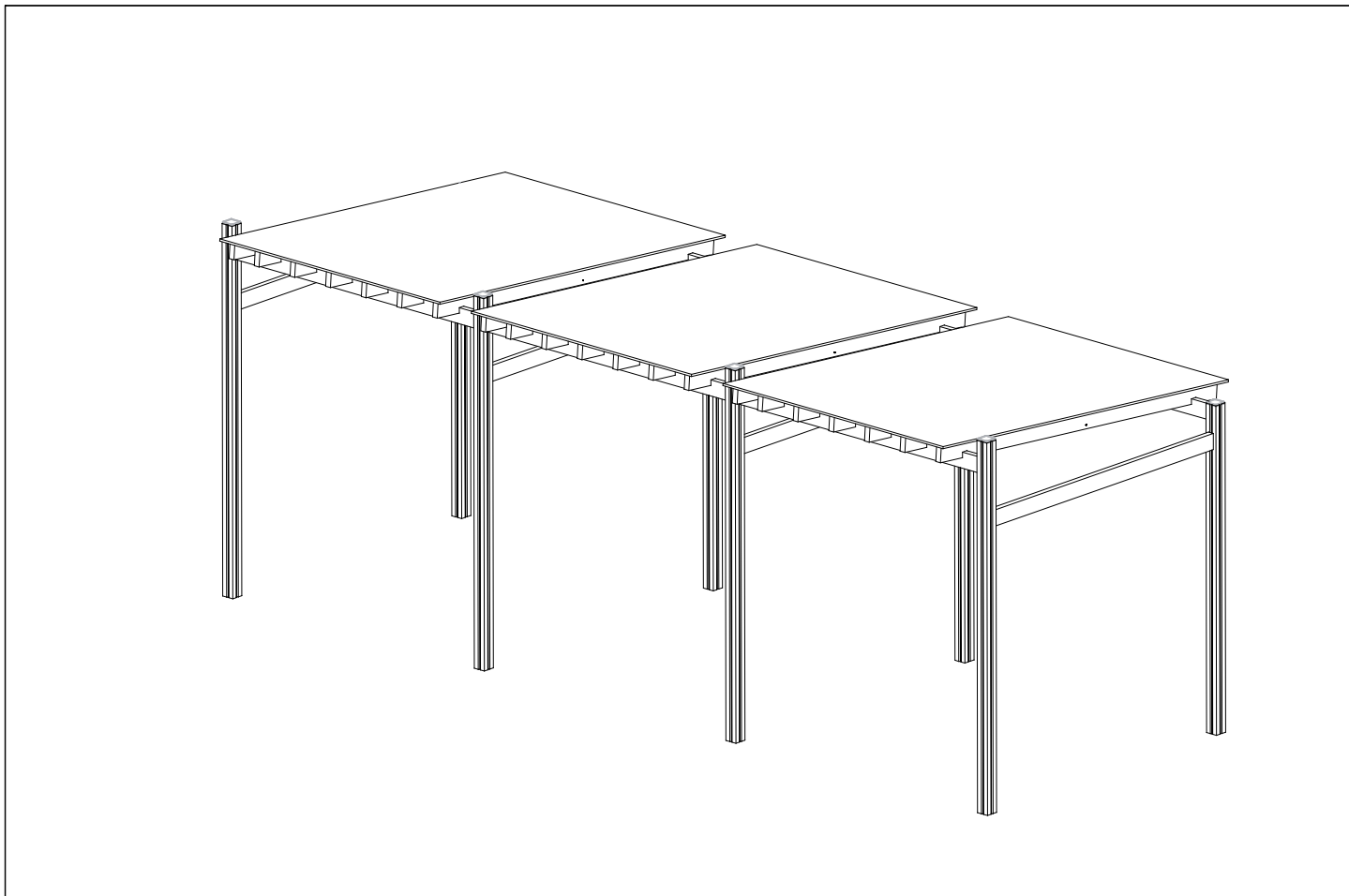

# PC- kerroslevyt

## Kylmät tilat -asennus PC-muovisin H-listoin

PC-kerroslevyistä voi H-listojen avulla helposti rakentaa tasomaisen valokatteen. Katteisiin soveltuvat 10 ja 16 mm paksuiset levyt.

**Huom! Asennus H-listan kanssa onnistuu parhaiten max. 3,5 m pituisilla levyillä.**

Asennus tapahtuu vaakaruoteiden päälle. Yleensä valokate päättyy ala- ja sivureunoilla alumiinisiin päätyprofiileihin. Kate ylittää ruoderungon vähintään 35 mm

H-listat saattavat kerätä likaa ilman epäpuhtauksista. Alumiinisilla valokatelistoilla asennettuna sauma pysyy puhtaampana.

Asennustapa PC-H

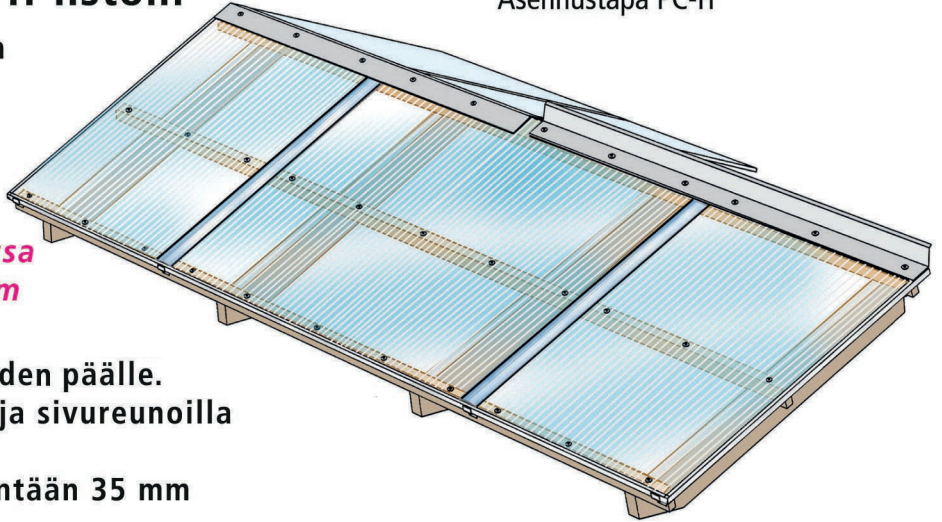

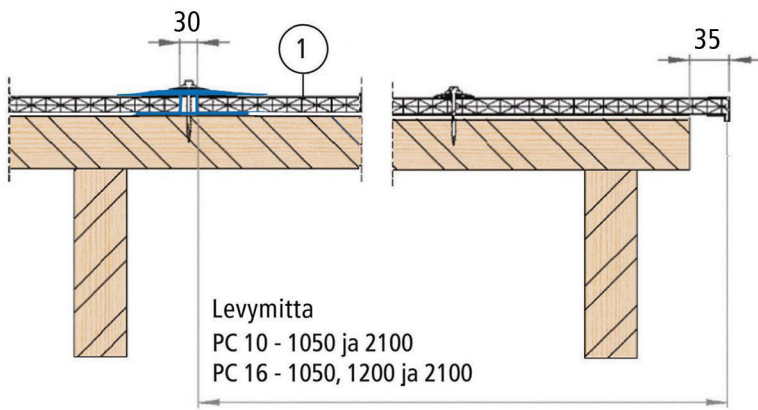

Levyymitta  
PC 10 - 1050 ja 2100  
PC 16 - 1050, 1200 ja 2100

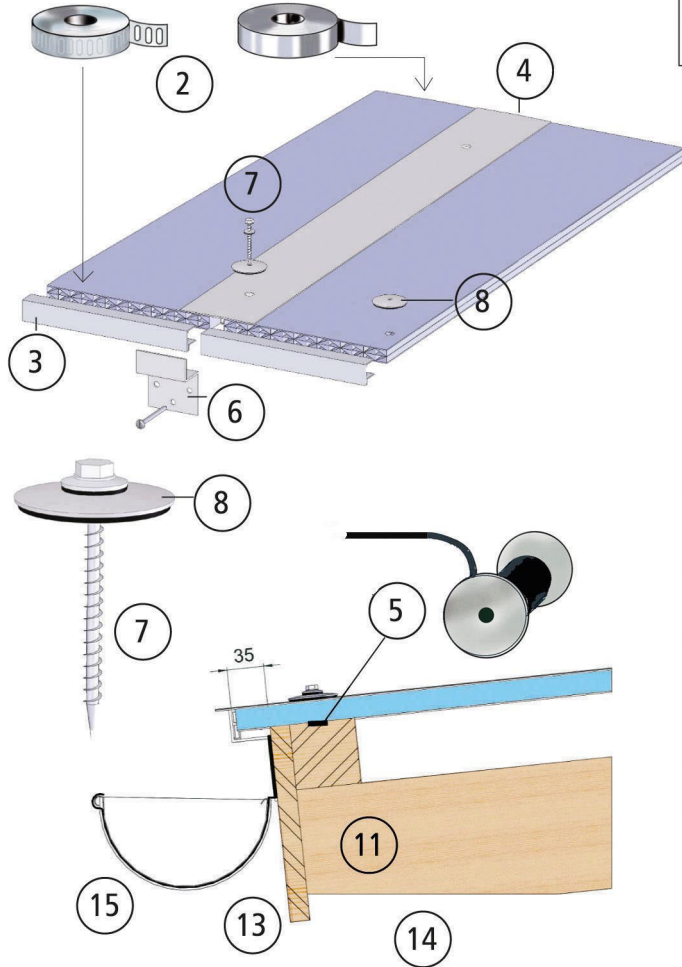
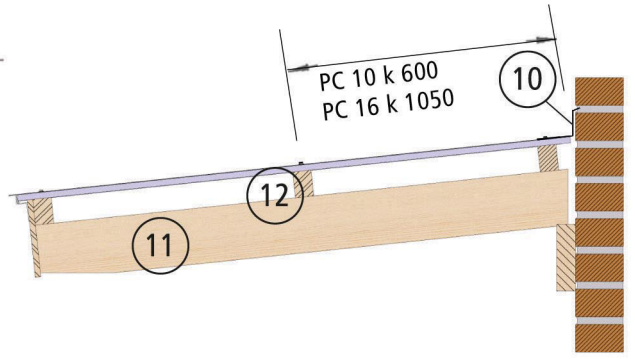

## Kylmät tilat - asennus H-listoin

1. PC-monikerroslevy  
paks. 10 mm, leveys 1050 ja 2100 mm  
paks. 16 mm, leveys 1050, 1200 ja 2100 mm
2. Suodatinteippi alareunaan ja alumiiniteippi yläreunaan
3. Päätelista, U-profiili, alumiinia, ala- ja sivureunoille
4. H-lista levyjen saumoissa, alapään sahaus muotoiltu ks. kuva
5. Vaakatiiviste 9 x 3 mm ruoteeseen nitoon
6. Z-toppari levysaumojen kohdalle ja metrin välein
7. Kateruuvi RST 4,8 x 50...60 mm, ylä- ja alareunassa k 500, loput tasaisesti 4-6 kpl / m<sup>2</sup>, esireikä 8 mm
8. Aluslevy ø 38 mm, 4-6 kpl / m<sup>2</sup>
10. Vesipelti, seinäliittymä 70 x 115 mm, RR 21
11. Kattokannattajat rakennesuunnitelman mukaan
12. Vaakaruoteet esim. 45 x 70, k 600...1050 mm
13. Otsalauta
14. Runko, perustus ja lattia rakennesuunnitelman mukaan
15. Mahdollinen räystäskouru

**Huom!**  
Levyt asennetaan siten, että painatuskuviot tulee ylös- / ulospäin (UV-suojaus)

## Muovilevyjen käsittelyohjeet



Levynipun säilytys sisällä tai hyvin peitettynä varjossa

Käytä erikoisporia



Liiku varovasti muovikatteen päällä. Käytä apuvälineinä vaahтомуovilla pehmustettuja lankkuja tai lapetikkaita

+5 °C

Suosittelava minimi lämpötila muovilevyjen asennuksessa

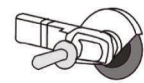

Paloittelu ohuella katkaisulaikalla

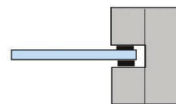

Muista lämpöliikunta 5 mm / m



Pesu runsaalla vedellä ja pehmeällä liinalla. Suositeltava pesuaine Fairy

**Tuotekyltti tulee tuotteen mukana yhdellä seuraavista tavoista:****1) Metallinen tuotekyltti ja kiinnitysruuvit**

- Kiinnitä tuotekyltti ruuveilla tolppaan noin 2 metrin korkeuteen kuvan 1 mukaisesti.

**2) Tuotekylttitarra**

- Puhdista maalattu metalli- tai vaneripinta pölystä ja kosteudesta. Liimaa tarra kuvan 2 mukaisesti.
- Huom. Älä kiinnitä tarraa karheapintaiseen laminaattiin tai maalattuun puuhun.

**Vår produktmärkning levereras på ett av följande sätt:****1) Produktskylt i metall**

- Fäst skylten med de medföljande skruvarna

**2) Självhäftande produktetikett**

- Rengör den pulverlackerade metallytan eller laminatyten så att den blir fri från smuts och fukt. Fäst etiketten enligt fig. 2.
- Obs! Fäst ej etiketten på detaljer med skrovlig yta eller på målat trä.

**Product label is delivered by one of following ways:****1) Metal product label and screws**

- Fasten the label with screws.

**2) Label sticker**

- Clean the painted metal or plywood surface from dirt and moisture. Fasten the sticker as shown in the figure 2.
- Note. Do not attach the sticker to rough surfaced laminate or painted wood.

**La plaque d'informations produit est livrée sous l'une de ces 3 formes :****1) Plaque métallique et vis**

- Fixez la plaque à l'aide des vis.

**2) Etiquette autocollante**

- Avant de coller l'étiquette, nettoyez le composant métallique peint ou la plaque de contreplaqué, de toute saleté. La surface doit être sèche (voir image 2).
- Attention, ne pas coller l'étiquette sur une surface lamellé-collée irrégulière ou sur du bois peint.

**Die Auslieferung des Produktaufklebers erfolgt auf eine dieser Arten:****1) Produkt-Schild aus Metall incl. Schrauben**

- Die Befestigung des Schildes erfolgt mittels der Schrauben.

**2) Aufkleber**

- Entfernen Sie zunächst Schmutz und Feuchtigkeit vom lackierten Metall bzw. von der Holzoberfläche und bringen Sie den Aufkleber wie im Bild oben rechts beschrieben auf den gesäuberten Untergrund auf.
- Beachten Sie: Bringen Sie den Aufkleber nicht auf raues laminiertes oder lackiertes Holz an.