

LAPPSET®

CLOVER



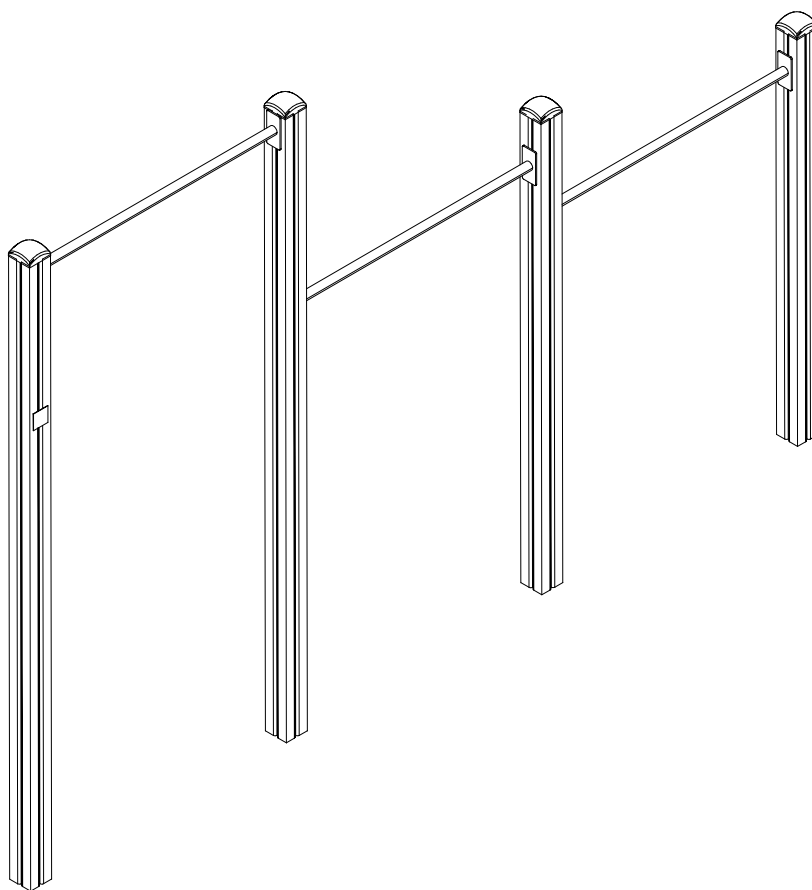

ASENNUSOHJE
MONTERINGSANSVISNING
INSTALLATION INSTRUCTION
AUFBAUANLEITUNG
NOTICE D'INSTALLATION

DATE: 18.7.2017

Q11582

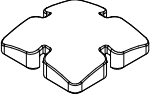
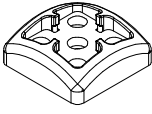
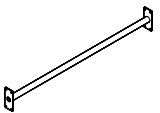
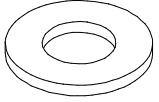
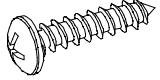
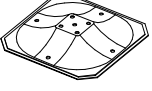
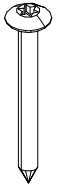
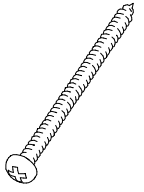

DATE: 18.7.2017

| | | | | | | | | | | | |
|---|----------|---|-----------|---|----------|---|----------|--|-----------|--|-----------|
| 702286  65x65 | PCS 1 | 706484  93x93x2150 | PCS 1 | 706568  93x93x3000 | PCS 2 | 706669  93x93x2400 | PCS 1 | 905138  GRAY | PCS 4 | 905196  GRAY | PCS 4 |
| 905838-216  L 1060 | PCS 3 | 909256  Ø16/8.4 | PCS 24 | 909506  Ø3.5x13 | PCS 4 | 909519  50x380x380 | PCS 4 | 980123  Ø7x60 | PCS 24 | 980131  Ø6x60 | PCS 16 |
| | PCS | | PCS | | PCS | | PCS | | PCS | | PCS |
| | PCS | | PCS | | PCS | | PCS | | PCS | | PCS |
| | PCS | | PCS | | PCS | | PCS | | PCS | | PCS |
| | PCS | | PCS | | PCS | | PCS | | PCS | | PCS |
| | PCS | | PCS | | PCS | | PCS | | PCS | | PCS |

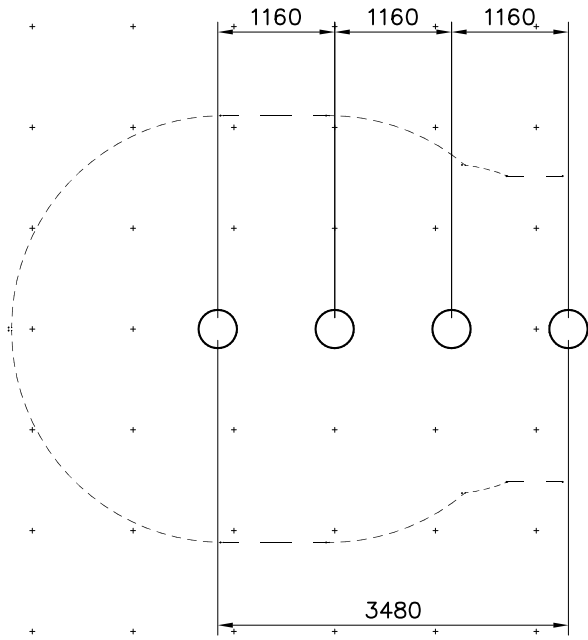
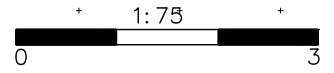

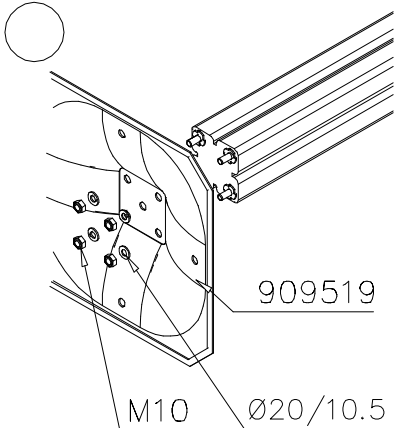
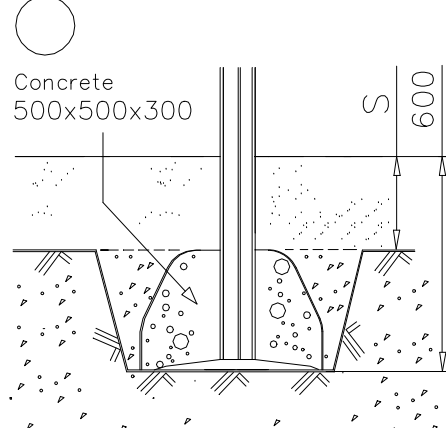
| | | |
|---|---|--|
|  <p>909519</p> <p>M10 Ø20/10.5</p> |  <p>Concrete 500x500x300</p> <p>600</p> | |
| | | |
| | | |
| | | |

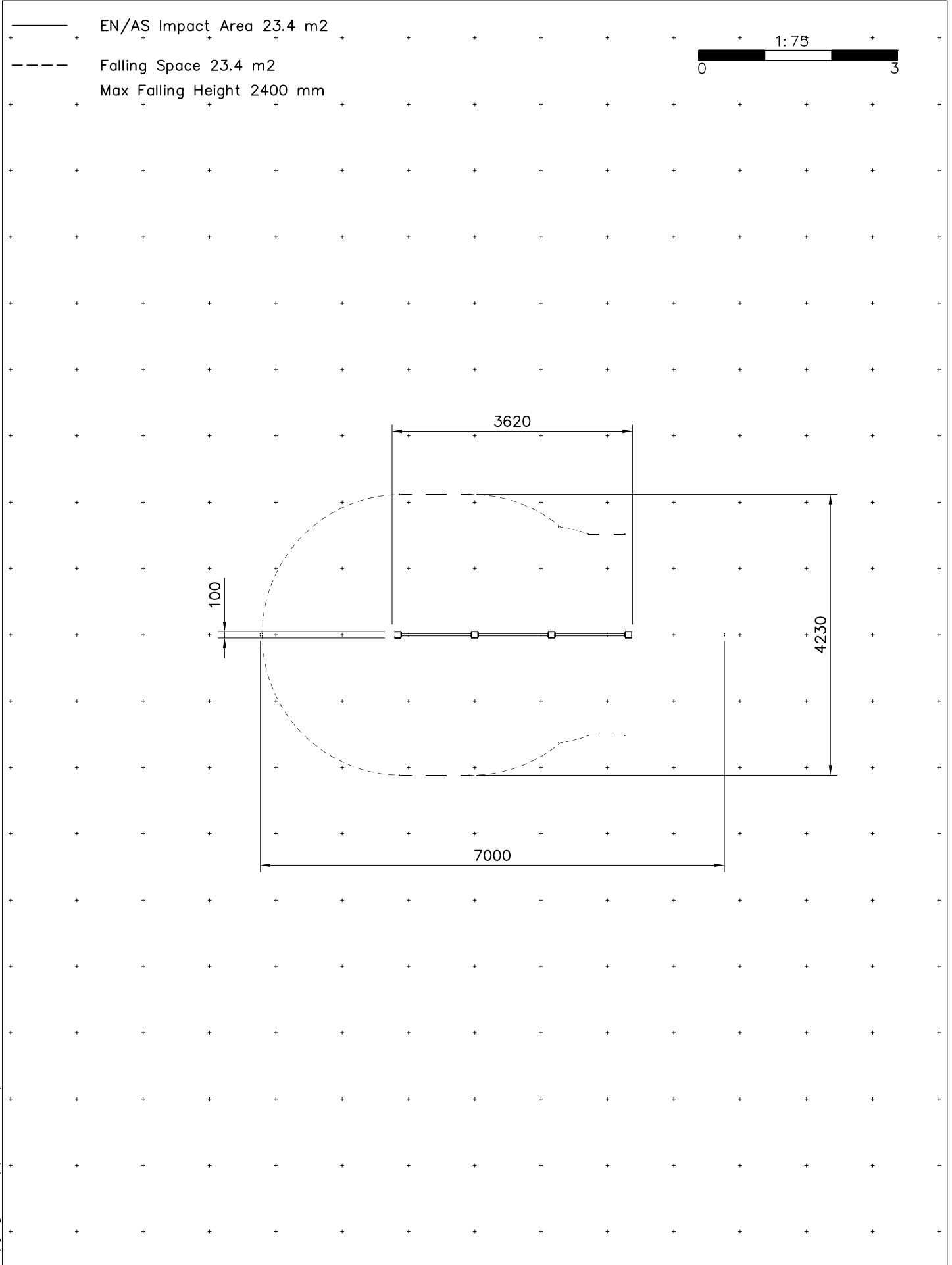

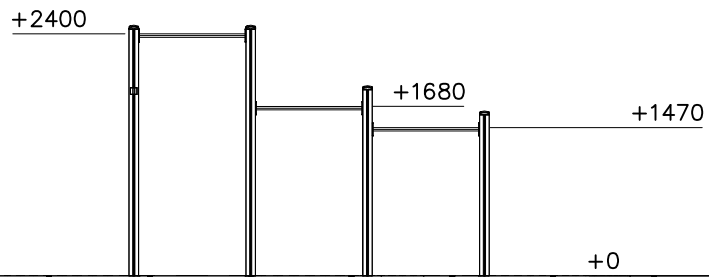

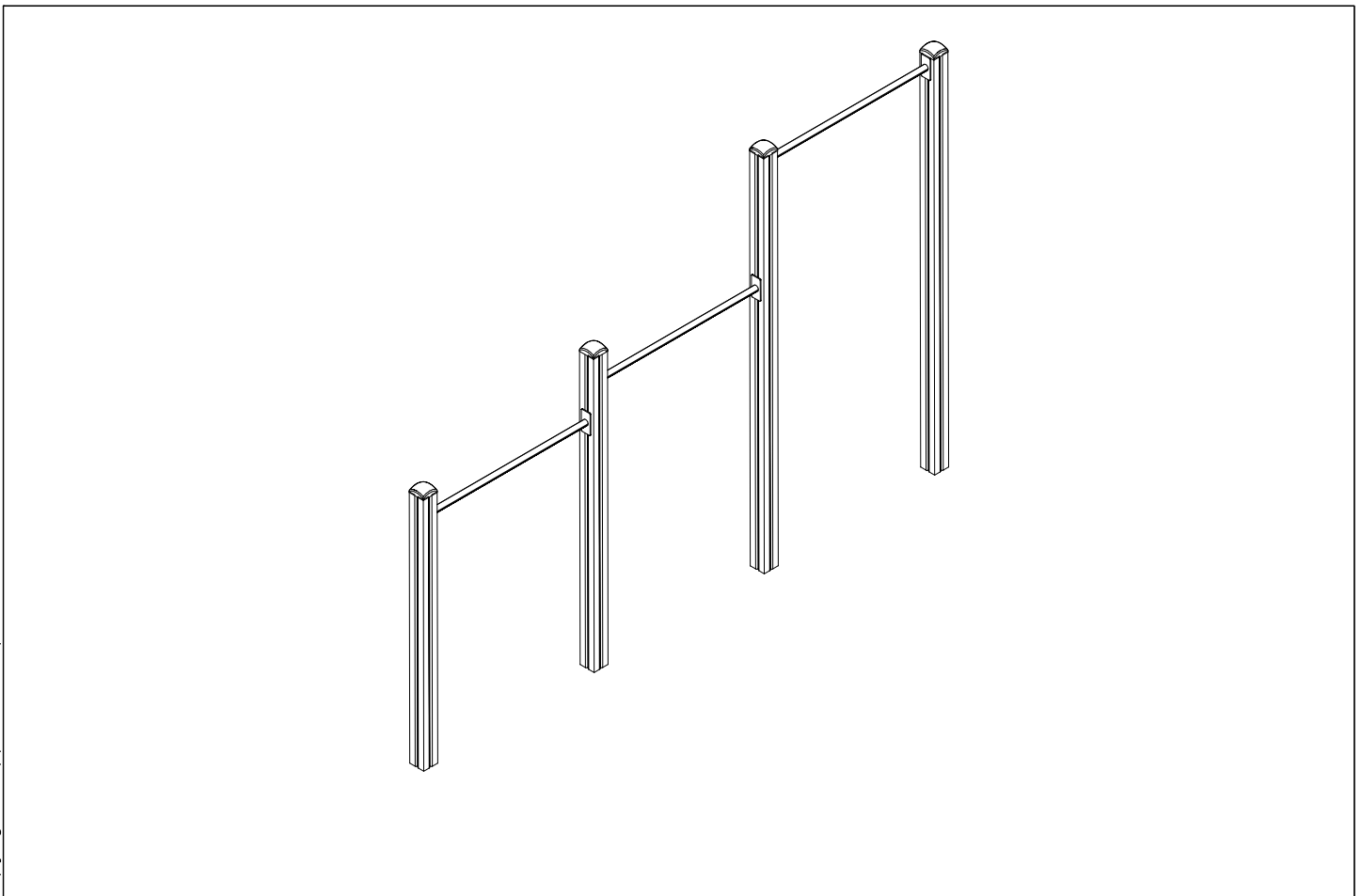
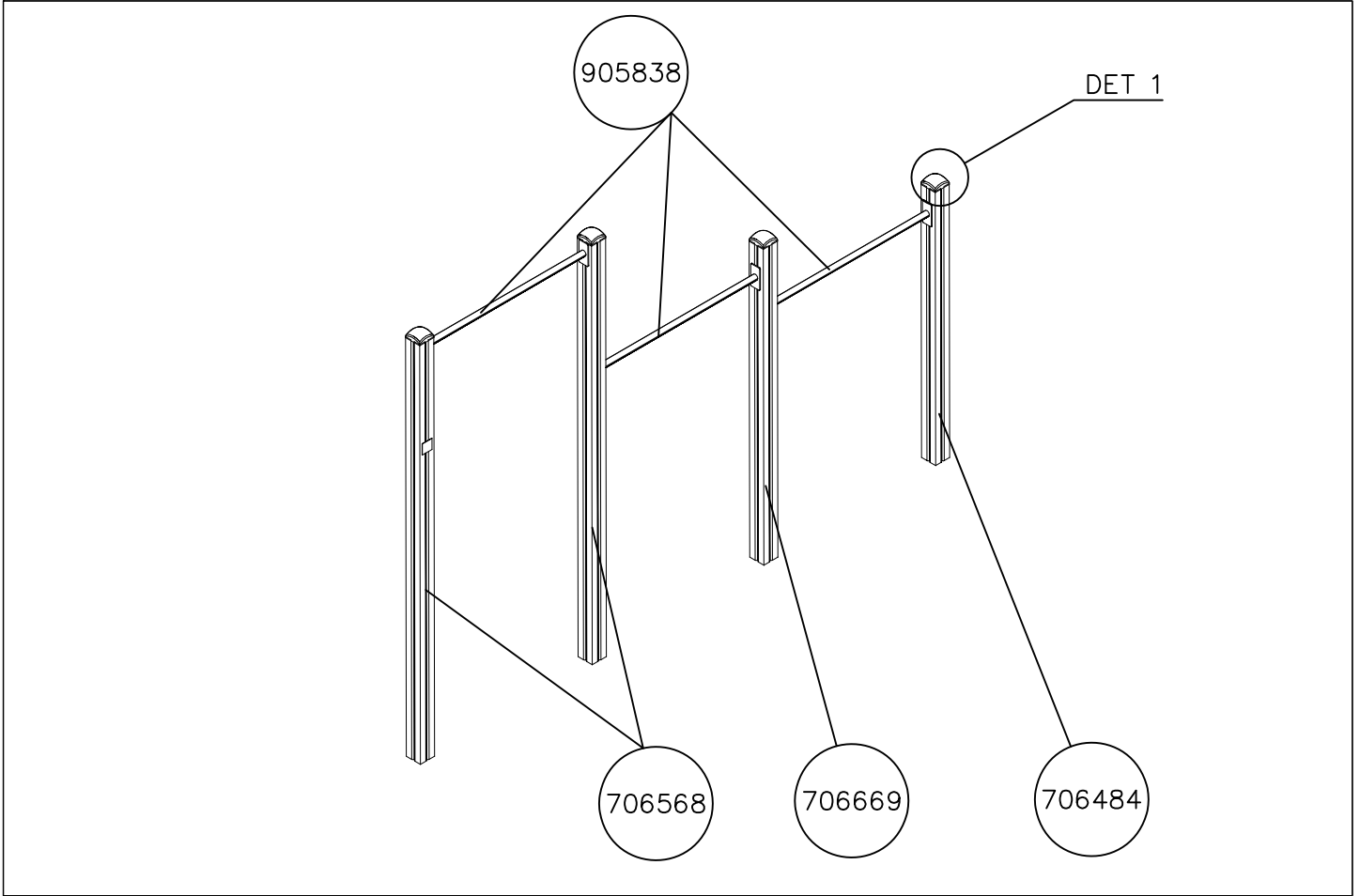

| | | | |
|--|--|--|--|
| <p>DET 1</p> <p>905138 Ø6x60 (980131) 905196</p> | | | |
| | | | |
| | | | |
| | | | |
| | | | |

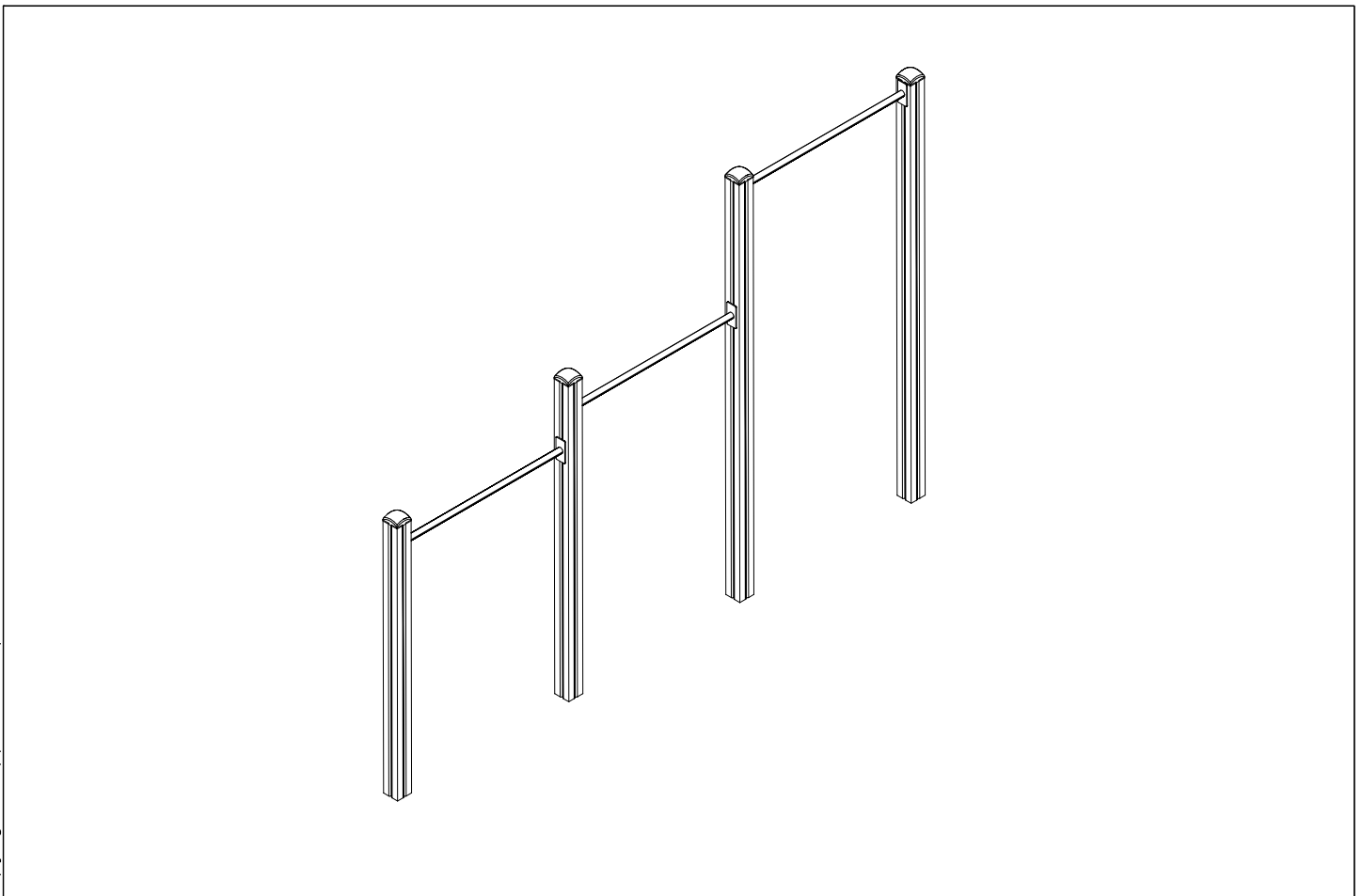
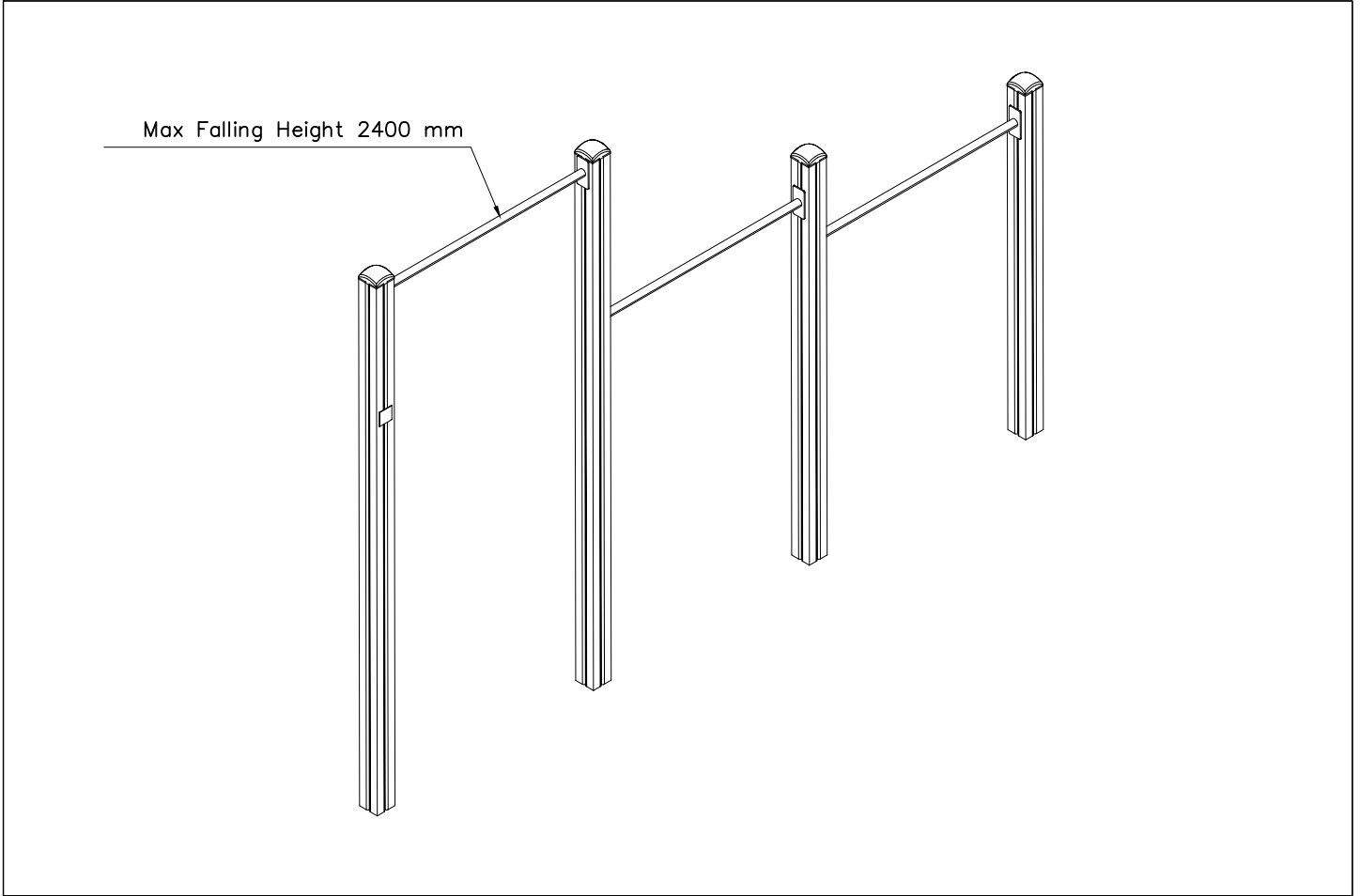



Tuotekyltti tulee tuotteen mukana yhdellä seuraavista tavoista:

1) Metallinen tuotekyltti ja kiinnitysruuvit

- Kiinnitä tuotekyltti ruuveilla tolppaan noin 2 metrin korkeuteen kuvan 1 mukaisesti.

2) Tuotekylttitarra

- Puhdista maalattu metalli- tai vaneripinta pölystä ja kosteudesta. Liimaa tarra kuvan 2 mukaisesti.
- Huom. Älä kiinnitä tarraa karheapintaiseen laminaattiin tai maalattuun puuhun.

Vår produktmärkning levereras på ett av följande sätt:

1) Produktskylt i metall

- Fäst skylten med de medföljande skruvarna

2) Självhäftande produktetikett

- Rengör den pulverlackerade metallytan eller laminatyten så att den blir fri från smuts och fukt. Fäst etiketten enligt fig. 2.
- Obs! Fäst ej etiketten på detaljer med skrovlig yta eller på målat trä.

Product label is delivered by one of following ways:

1) Metal product label and screws

- Fasten the label with screws.

2) Label sticker

- Clean the painted metal or plywood surface from dirt and moisture. Fasten the sticker as shown in the figure 2.
- Note. Do not attach the sticker to rough surfaced laminate or painted wood.

La plaque d'informations produit est livrée sous l'une de ces 3 formes :

1) Plaque métallique et vis

- Fixez la plaque à l'aide des vis.

2) Etiquette autocollante

- Avant de coller l'étiquette, nettoyez le composant métallique peint ou la plaque de contreplaqué, de toute saleté. La surface doit être sèche (voir image 2).
- Attention, ne pas coller l'étiquette sur une surface lamellé-collée irrégulière ou sur du bois peint.

Die Auslieferung des Produktaufklebers erfolgt auf eine dieser Arten:

1) Produkt-Schild aus Metall incl. Schrauben

- Die Befestigung des Schildes erfolgt mittels der Schrauben.

2) Aufkleber

- Entfernen Sie zunächst Schmutz und Feuchtigkeit vom lackierten Metall bzw. von der Holzoberfläche und bringen Sie den Aufkleber wie im Bild oben rechts beschrieben auf den gesäuberten Untergrund auf.
- Beachten Sie: Bringen Sie den Aufkleber nicht auf raues laminiertes oder lackiertes Holz an.