

LAPPSET®

THEME







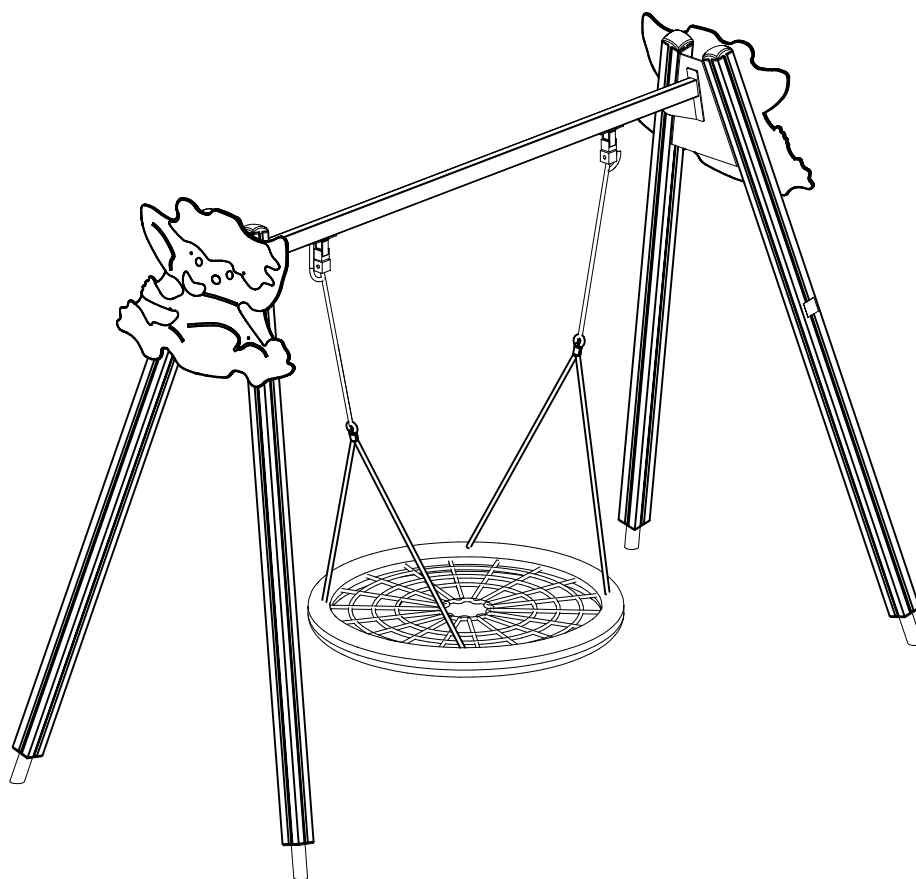



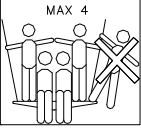

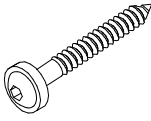

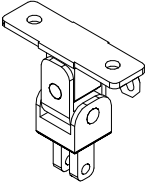

ASENNUSOHJE
MONTERINGSANSVISNING
INSTALLATION INSTRUCTION
AUFBAUANLEITUNG
NOTICE D'INSTALLATION

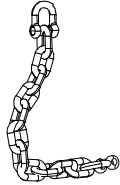
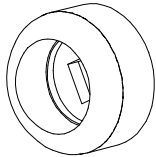
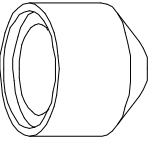
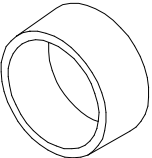
DATE: 8.6.2017

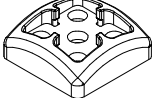
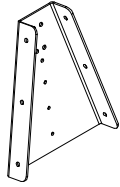
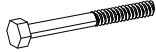
Q11455

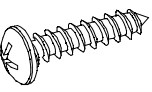
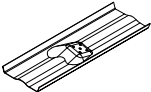
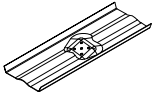
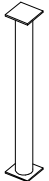
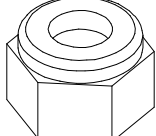
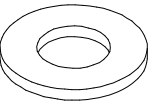
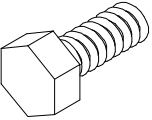
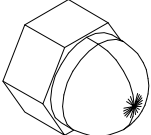
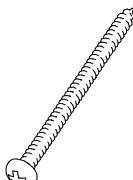

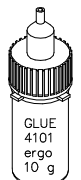
DATE: 30.4.2017

702286  65x65	PCS 1	702533  118x78	PCS 1	703248  L2650	PCS 1	706564-603  L2650	PCS 4	900240  8x70	PCS 8	900965  M10	PCS 4
901958 	PCS 2	901959  L2940	PCS 1	902234  M12	PCS 4	903149  M12x30	PCS 4	903577 	PCS 2	905090  Ø45	PCS 12
905104  M10	PCS 16	905115  Ø30	PCS 12	905138 	PCS 4	905196 	PCS 4	905991 	PCS 2	906499  M12x110	PCS 4
909347  M12x35	PCS 12	909506  Ø3.5x13	PCS 8	909507  L 1000	PCS 2	909508  L 1000	PCS 2	909511  L650	PCS 4	909637  M10	PCS 16
909638  Ø20/10.5	PCS 40	909639  M10x25	PCS 20	909644  M12	PCS 4	980131  Ø6x60	PCS 16	980154  Ø24/13	PCS 28	999561  10g	PCS 1
P11080 	PCS 2		PCS		PCS		PCS		PCS		PCS
	PCS		PCS		PCS		PCS		PCS		PCS

EN/AS Impact Area 19.9 m²

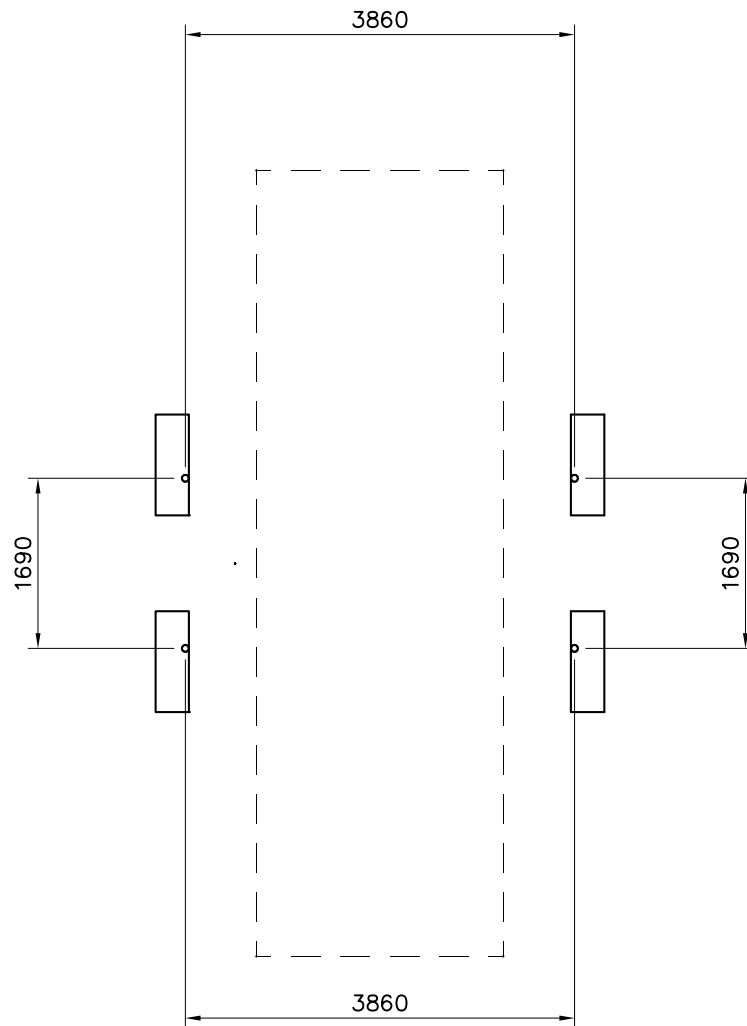
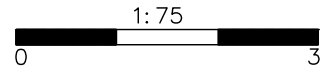

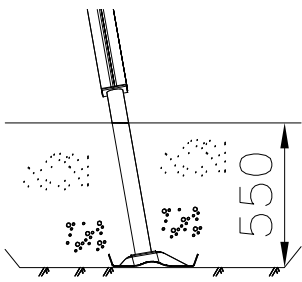
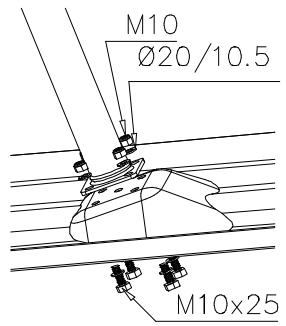
 <p>550</p>	 <p>M10 Ø20/10.5 M10x25</p>	

- EN/AS Impact Area 19.0 m²
- - - - Falling Space 19.0 m²
- Max Falling Height 1400 mm

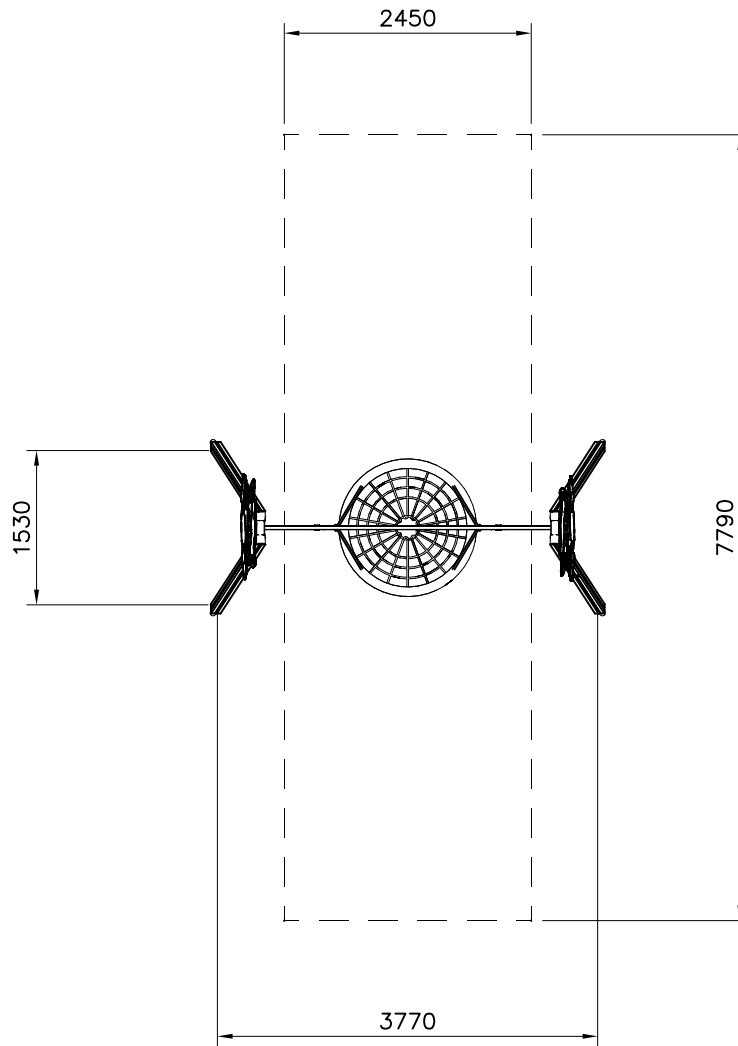
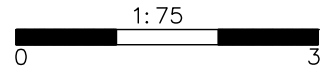

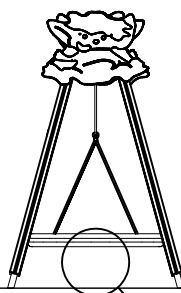
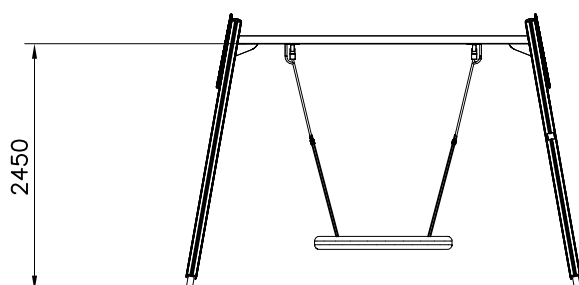

DET 5

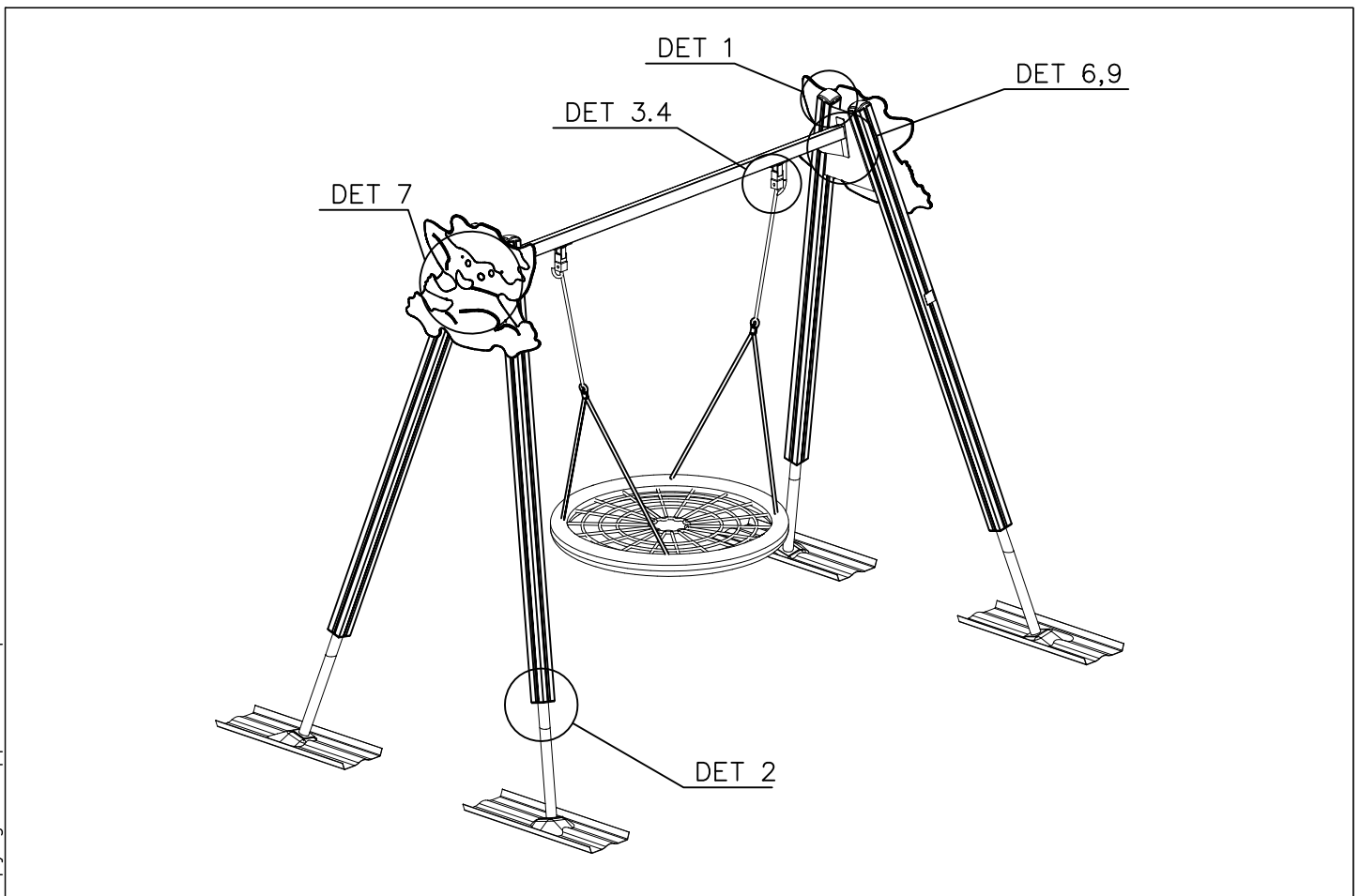
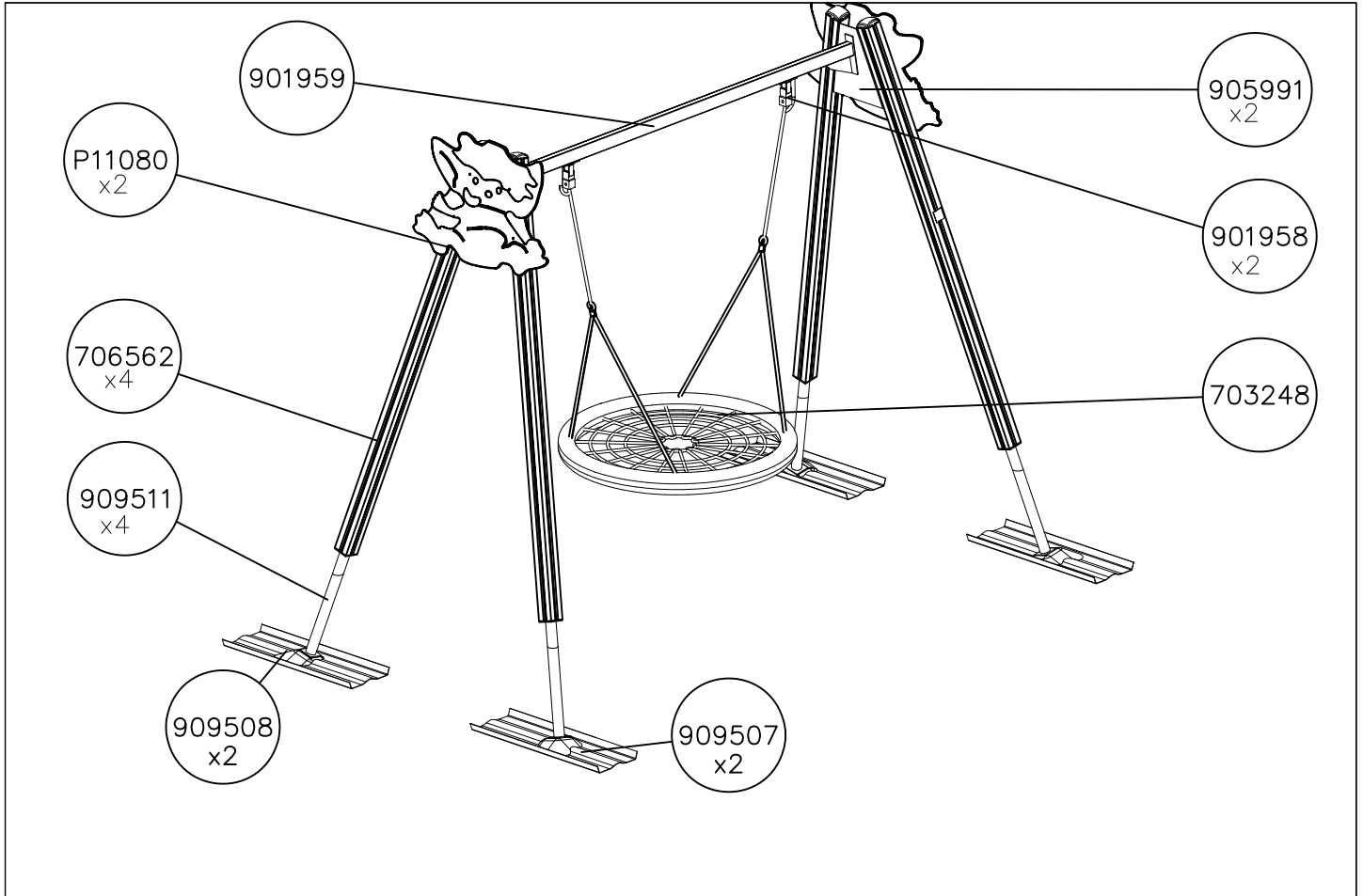

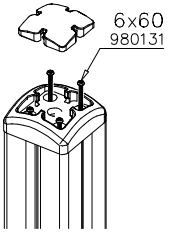
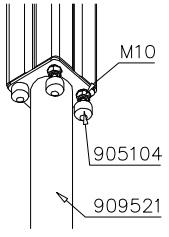
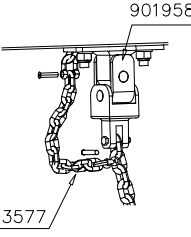
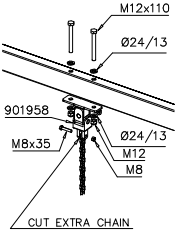
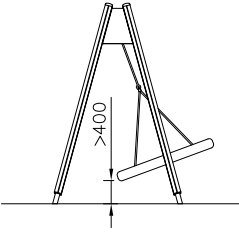
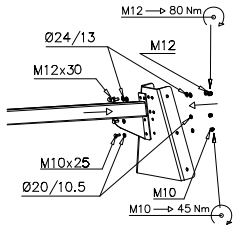
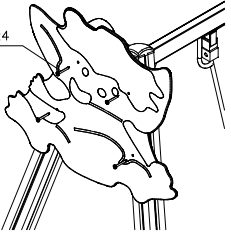
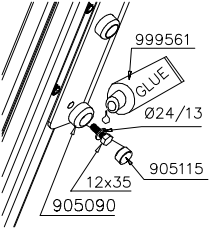
<p>DET 1</p>  <p>6x60 980131</p>	<p>DET 2</p>  <p>M10 905104 909521</p>	<p>DET 3</p>  <p>901958 903577</p>	<p>DET 4</p>  <p>M12x110 Ø24/13 901958 Ø24/13 M8x35 M12 M8 CUT EXTRA CHAIN</p>
<p>DET 5</p>  <p>>400</p>	<p>DET 6</p>  <p>M12 → 80 Nm Ø24/13 M12 M12x30 M10x25 Ø20/10.5 M10 → 45 Nm</p>	<p>DET 7</p>  <p>900240x4</p>	
<p>DET 9</p>  <p>999561 GLUE Ø24/13 12x35 905115 905090</p>			

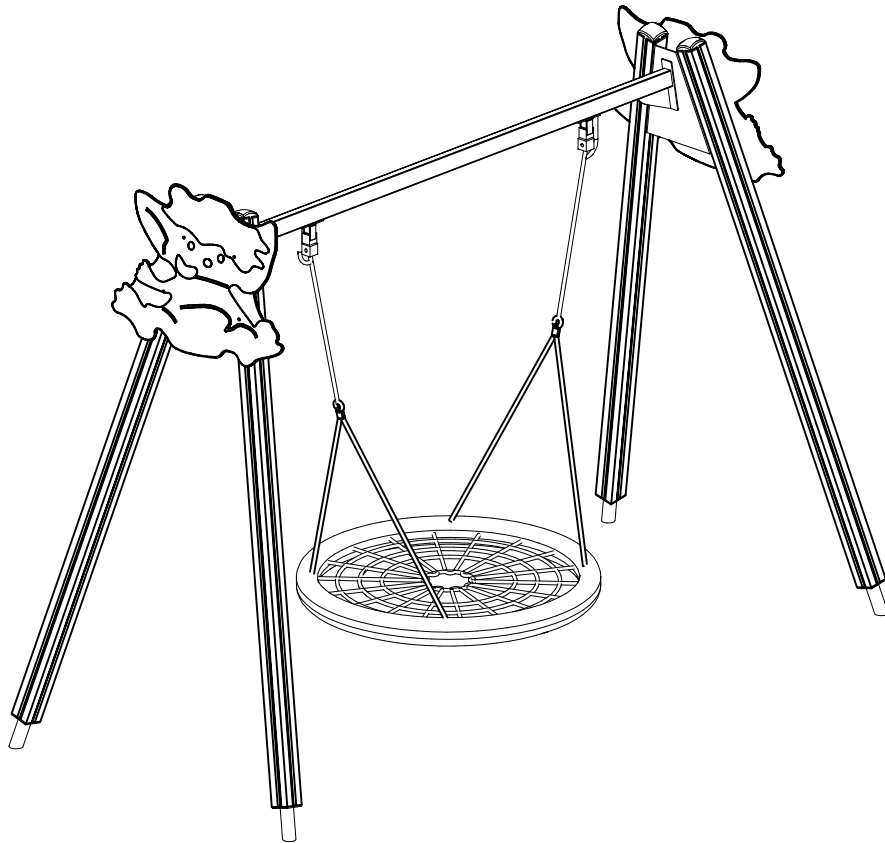
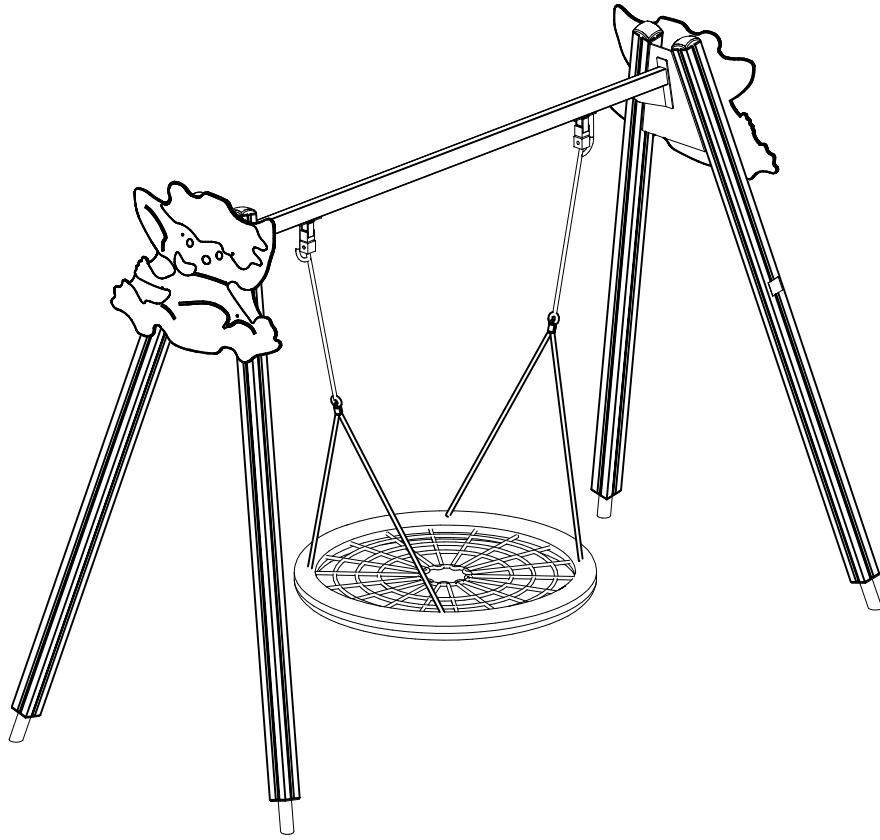

												
<p>$h < 600$</p> <p>Without movement and therefore without Impact Area</p>	<p>Totally hard surfaces.</p> <p>Note. Lappset does <u>not recommend</u> totally hard surfaces at all.</p>	<p>E.g. concrete or asphalt</p> 										
<p>$h < 600$</p> <p>With movement e.g. rocking</p>	<p>Materials with very limited impact attenuating properties.</p>	<p>E.g. wood</p> 										
<p>$h < 1000$</p>	<p>Materials with significant impact attenuating properties.</p>	<p>fine gravel 0–8 mm</p>  <p>grass</p>  <p>unsorted sand</p> 										
<p>$h < 3000$</p>	<p>Loose fill material</p> <p>E.g. sand/gravel 0,25...8 mm D60/D10<3,0 Woodchips 5...30 mm bark 20...80 mm</p>	 <table data-bbox="1021 1691 1332 1792"> <tr> <td>\underline{S}</td> <td>\underline{h}</td> </tr> <tr> <td>30 cm</td> <td>< 2,0 m</td> </tr> <tr> <td>40 cm</td> <td>< 3,0 m</td> </tr> </table>	\underline{S}	\underline{h}	30 cm	< 2,0 m	40 cm	< 3,0 m				
\underline{S}	\underline{h}											
30 cm	< 2,0 m											
40 cm	< 3,0 m											
	<p>Syntethic granulates</p> <table data-bbox="406 1892 758 2060"> <tr> <td>\underline{S}</td> <td>\underline{h}</td> </tr> <tr> <td>40 mm</td> <td>~> 1,2...1,3 m</td> </tr> <tr> <td>50 mm</td> <td>~> 1,5...1,7 m</td> </tr> <tr> <td>60 mm</td> <td>~> 1,8...2,0 m</td> </tr> <tr> <td>70 mm</td> <td>~> 2,1...2,5 m</td> </tr> </table> <p>Note. For accurate values, see manufacturer's instructions.</p>	\underline{S}	\underline{h}	40 mm	~> 1,2...1,3 m	50 mm	~> 1,5...1,7 m	60 mm	~> 1,8...2,0 m	70 mm	~> 2,1...2,5 m	
\underline{S}	\underline{h}											
40 mm	~> 1,2...1,3 m											
50 mm	~> 1,5...1,7 m											
60 mm	~> 1,8...2,0 m											
70 mm	~> 2,1...2,5 m											

REMOVE SAFETY SURFACE/SAND/GRAVEL
TO CHECK FOUNDATION



REMOVE SAFETY SURFACE/SAND/GRAVEL
TO CHECK FOUNDATION



DET A

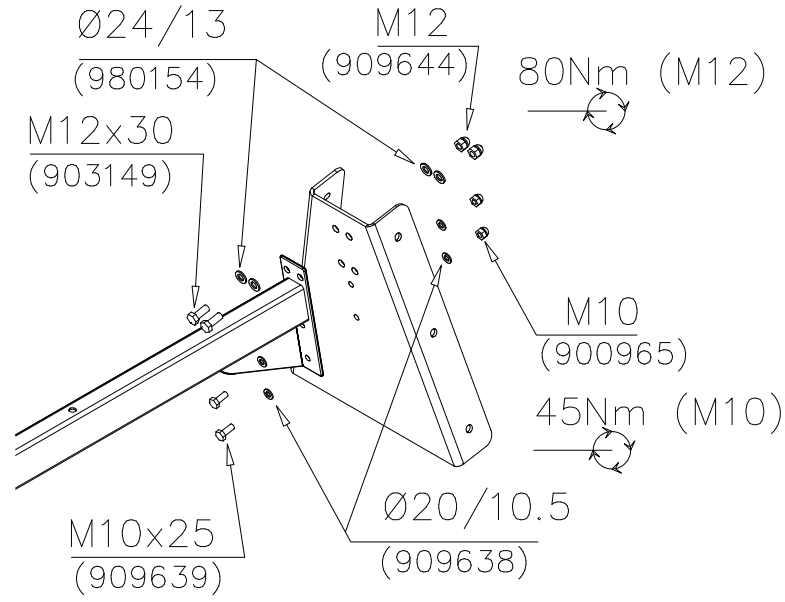

-  M12x30 2 pcs
-  Ø24/13 4 pcs
-  M12 2 pcs
-  M10x25 2 pcs
-  Ø20/10.5 4 pcs
-  M10 2 pcs
-  905991 1 pcs

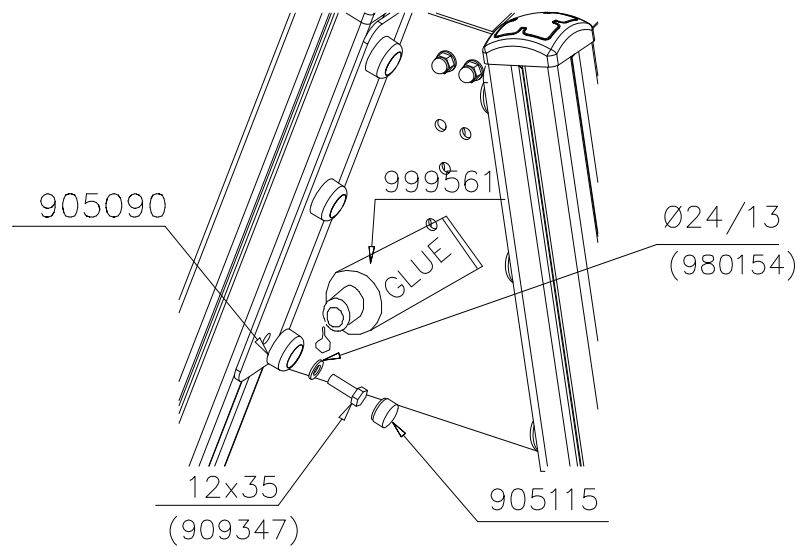

DET A1

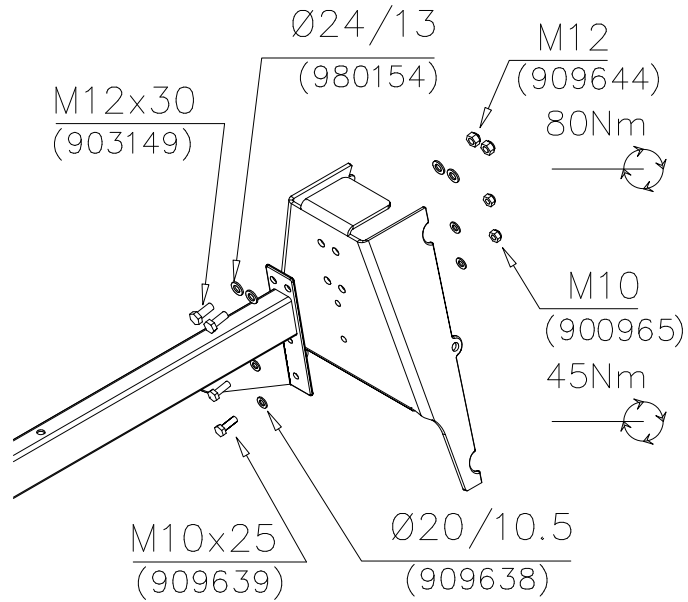

-  M12x35 6 pcs
-  Ø24/13 6 pcs
-  Ø45 6 pcs
-  Ø30 6 pcs
-  GLUE

DET B

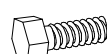

-  M12x30 2 pcs
-  Ø24/13 4 pcs
-  M12 2 pcs
-  M10x25 2 pcs
-  Ø20/10.5 4 pcs
-  M10 2 pcs

DET B

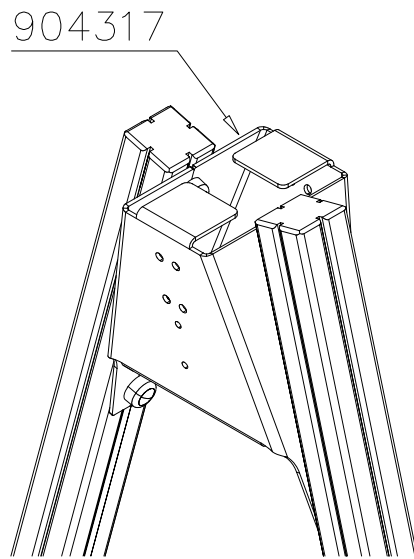

904317

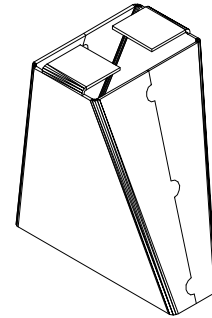

904317

DET B1

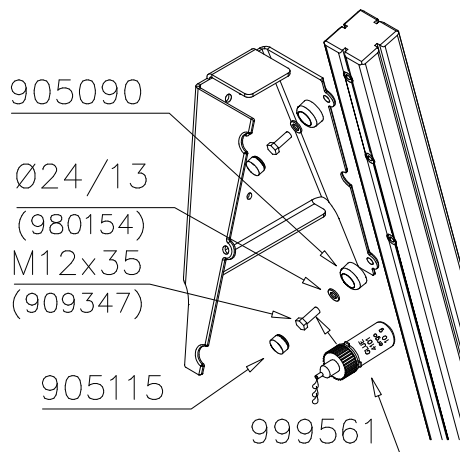

905090

Ø24/13

(980154)

M12x35

(909347)

905115

999561



M12x35 6 pcs



Ø24/13 6 pcs

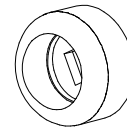

Ø45 6 pcs

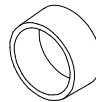

Ø30 6 pcs



GLUE

DET C

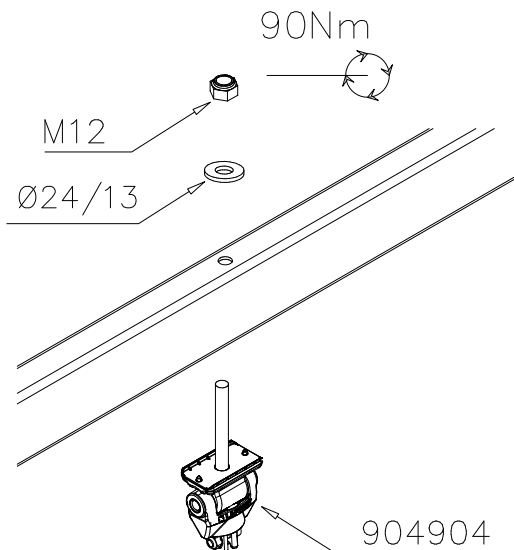

90Nm

M12

Ø24/13

904904

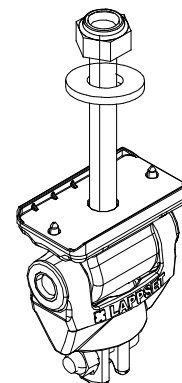

904904

DET D

90Nm

M12x110 (906499)

Ø24/13 (980154)

901958

M8x35

Ø24/13 (980154)

M12 (902234)

M8

CUT EXTRA CHAIN

M12x110 2 pcs

Ø24/13 4 pcs

M12 2 pcs

901958 1 pcs

DET D

903577

903577 1 pcs

DET E

6x60 980131

980131 4 pcs

905138 1 pcs

905196 1 pcs

REF: SWING
DATE: 29.6.2022

DET F

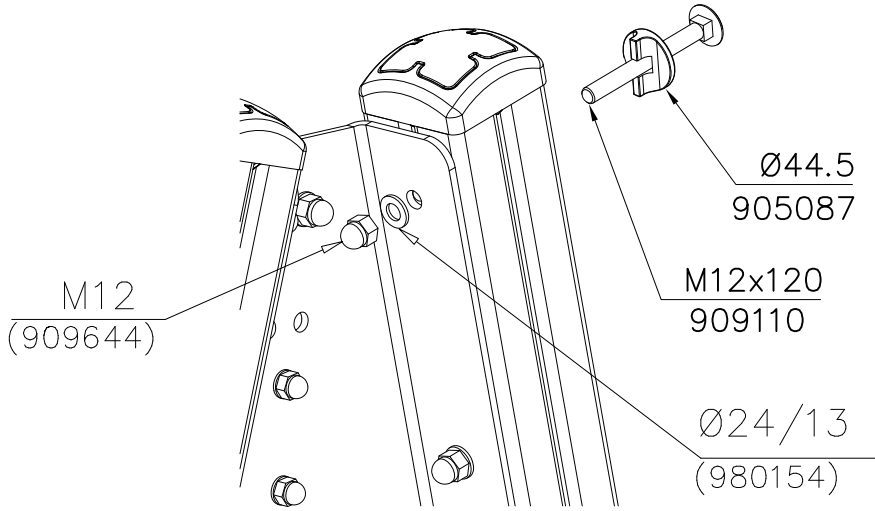

DET G



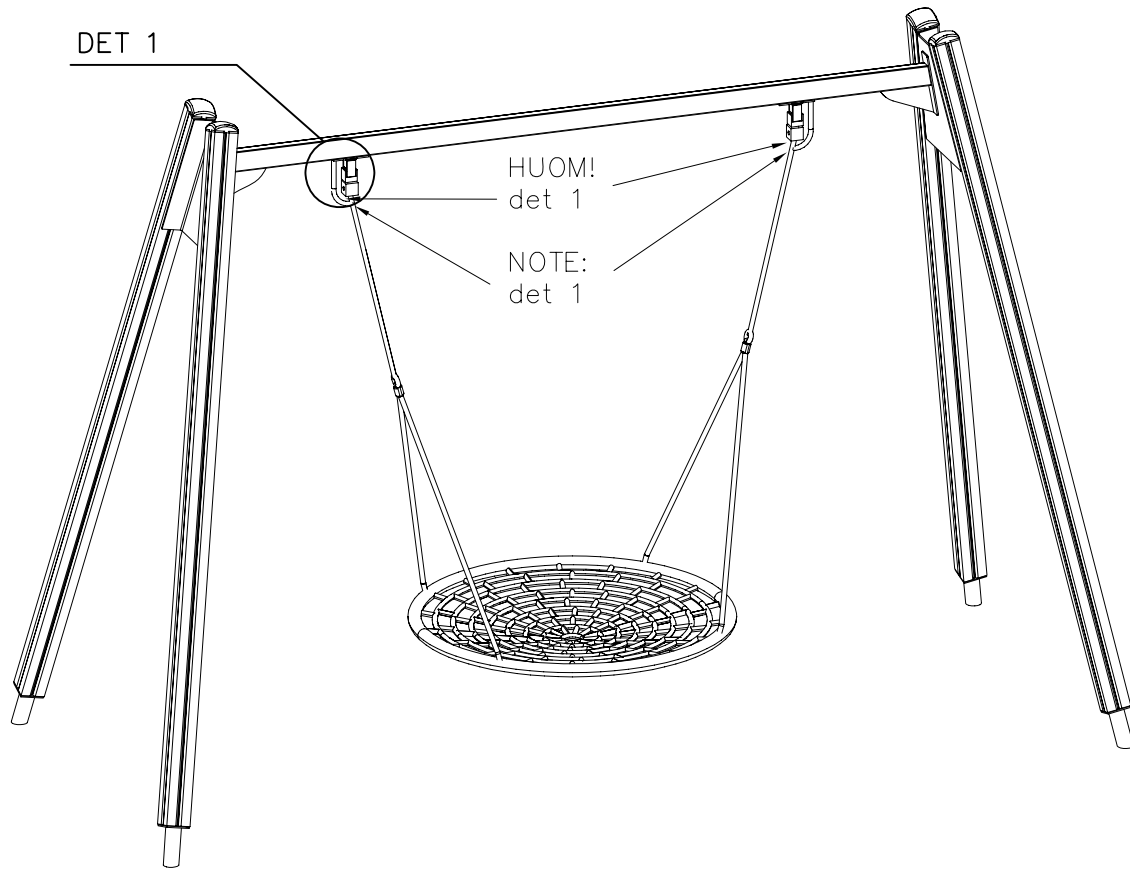

DET 1

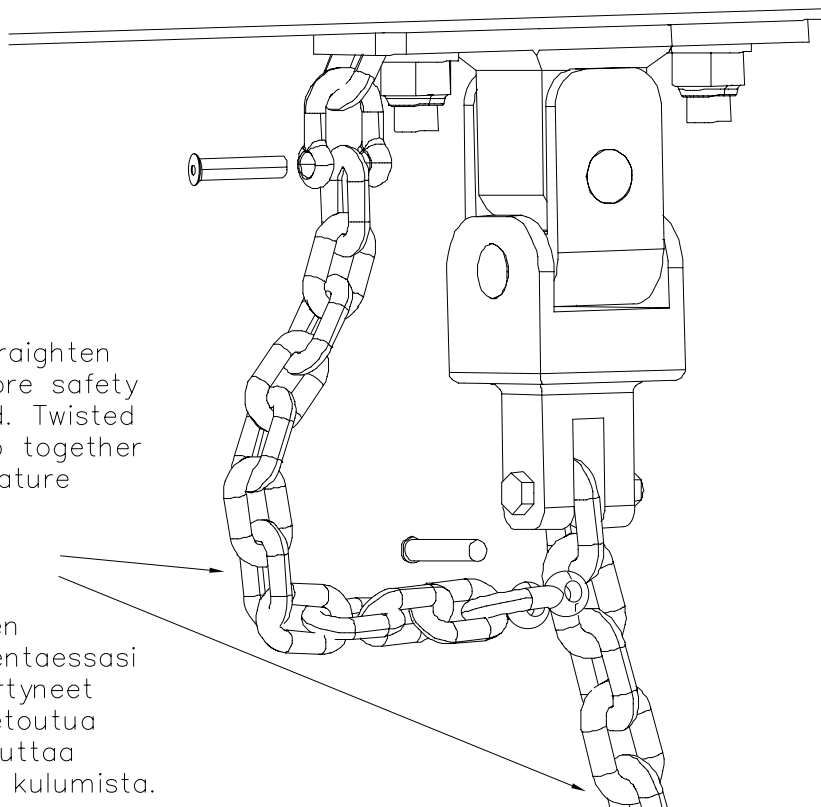

LAPPSET® BETON FOUNDATION

FOOT

DATE: 27.10.2015

1(1)

② 905104	PCS		PCS
	4		
 M10	PCS		PCS



905104

**Tuotekyltti tulee tuotteen mukana yhdellä seuraavista tavoista:****1) Metallinen tuotekyltti ja kiinnitysruuvit**

- Kiinnitä tuotekyltti ruuveilla tolppaan noin 2 metrin korkeuteen kuvan 1 mukaisesti.

2) Tuotekylttitarra

- Puhdista maalattu metalli- tai vaneripinta pölystä ja kosteudesta. Liimaa tarra kuvan 2 mukaisesti.
- Huom. Älä kiinnitä tarraa karheapintaiseen laminaattiin tai maalattuun puuhun.

Vår produktmärkning levereras på ett av följande sätt:**1) Produktskylt i metall**

- Fäst skylten med de medföljande skruvarna

2) Självhäftande produktetikett

- Rengör den pulverlackerade metallytan eller laminatyten så att den blir fri från smuts och fukt. Fäst etiketten enligt fig. 2.
- Obs! Fäst ej etiketten på detaljer med skrovlig yta eller på målat trä.

Product label is delivered by one of following ways:**1) Metal product label and screws**

- Fasten the label with screws.

2) Label sticker

- Clean the painted metal or plywood surface from dirt and moisture. Fasten the sticker as shown in the figure 2.
- Note. Do not attach the sticker to rough surfaced laminate or painted wood.

La plaque d'informations produit est livrée sous l'une de ces 3 formes :**1) Plaque métallique et vis**

- Fixez la plaque à l'aide des vis.

2) Etiquette autocollante

- Avant de coller l'étiquette, nettoyez le composant métallique peint ou la plaque de contreplaqué, de toute saleté. La surface doit être sèche (voir image 2).
- Attention, ne pas coller l'étiquette sur une surface lamellé-collée irrégulière ou sur du bois peint.

Die Auslieferung des Produktaufklebers erfolgt auf eine dieser Arten:**1) Produkt-Schild aus Metall incl. Schrauben**

- Die Befestigung des Schildes erfolgt mittels der Schrauben.

2) Aufkleber

- Entfernen Sie zunächst Schmutz und Feuchtigkeit vom lackierten Metall bzw. von der Holzoberfläche und bringen Sie den Aufkleber wie im Bild oben rechts beschrieben auf den gesäuberten Untergrund auf.
- Beachten Sie: Bringen Sie den Aufkleber nicht auf raues laminiertes oder lackiertes Holz an.