

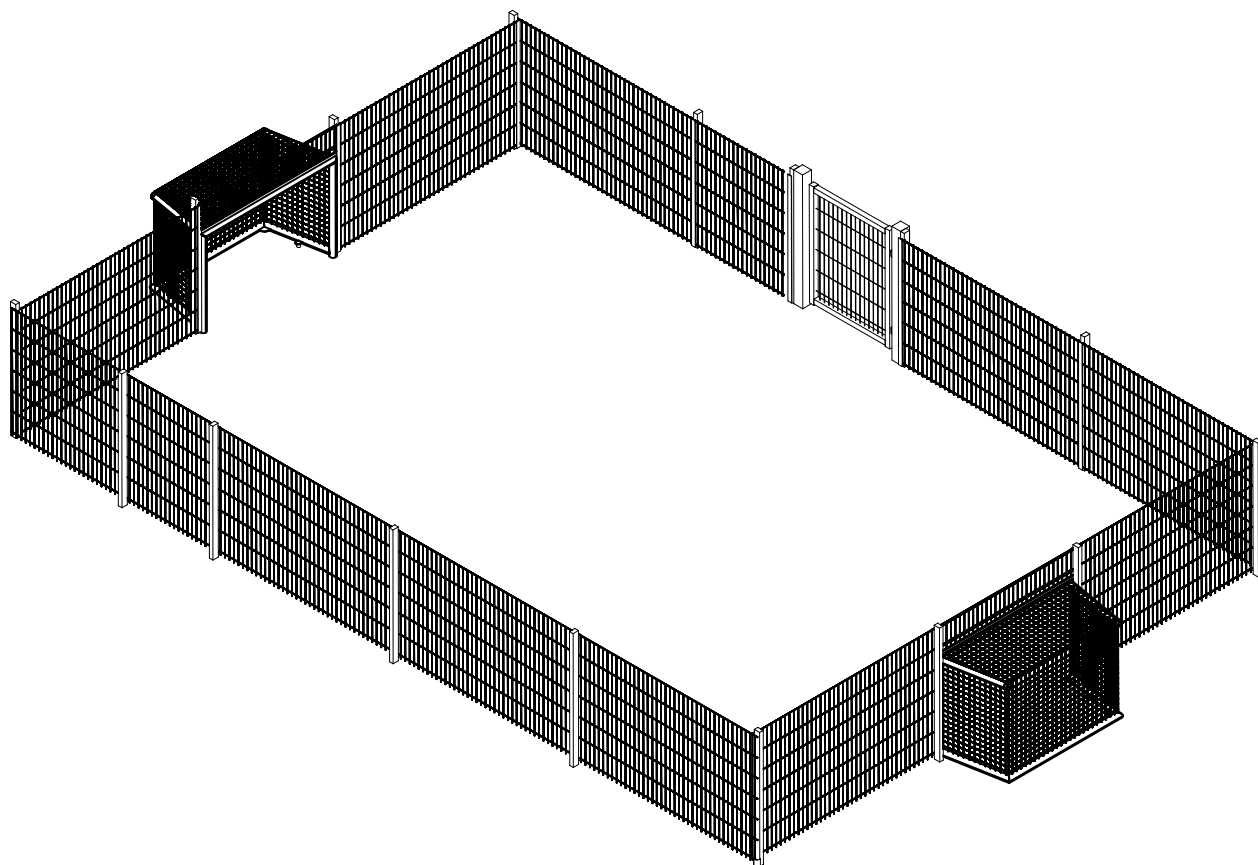





ASENNUSOHJE
MONTERINGSANSVISNING
INSTALLATION INSTRUCTION
AUFBAUANLEITUNG
NOTICE D'INSTALLATION

DATE: 16.3.2017

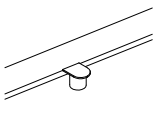
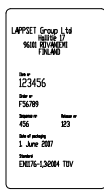

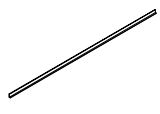
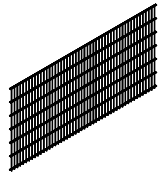
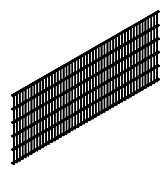
DATE: 16.3.2017

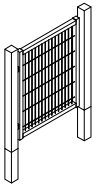
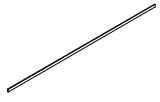
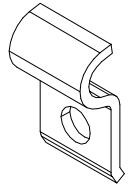
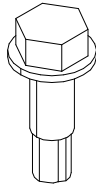
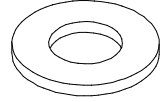
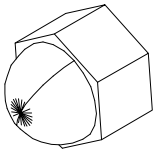
080950	PCS 2	702341	PCS 1	905827	PCS 16	907023	PCS 2	907350	PCS 12	907351	PCS 1
											
		90x50		M8x20		12x30x1556		1230x2500		1030x2500	
907359	PCS 16	907650	PCS 1	907654	PCS 2	907730	PCS 28	907731	PCS 28	909256	PCS 16
											
40x60x1700		1230x1000		3x25x1556		30x16x9		Ø5,5x19		Ø16/8.4	
909633	PCS 16		PCS		PCS		PCS		PCS		PCS
											
M8											
	PCS		PCS		PCS		PCS		PCS		PCS
	PCS		PCS		PCS		PCS		PCS		PCS
	PCS		PCS		PCS		PCS		PCS		PCS

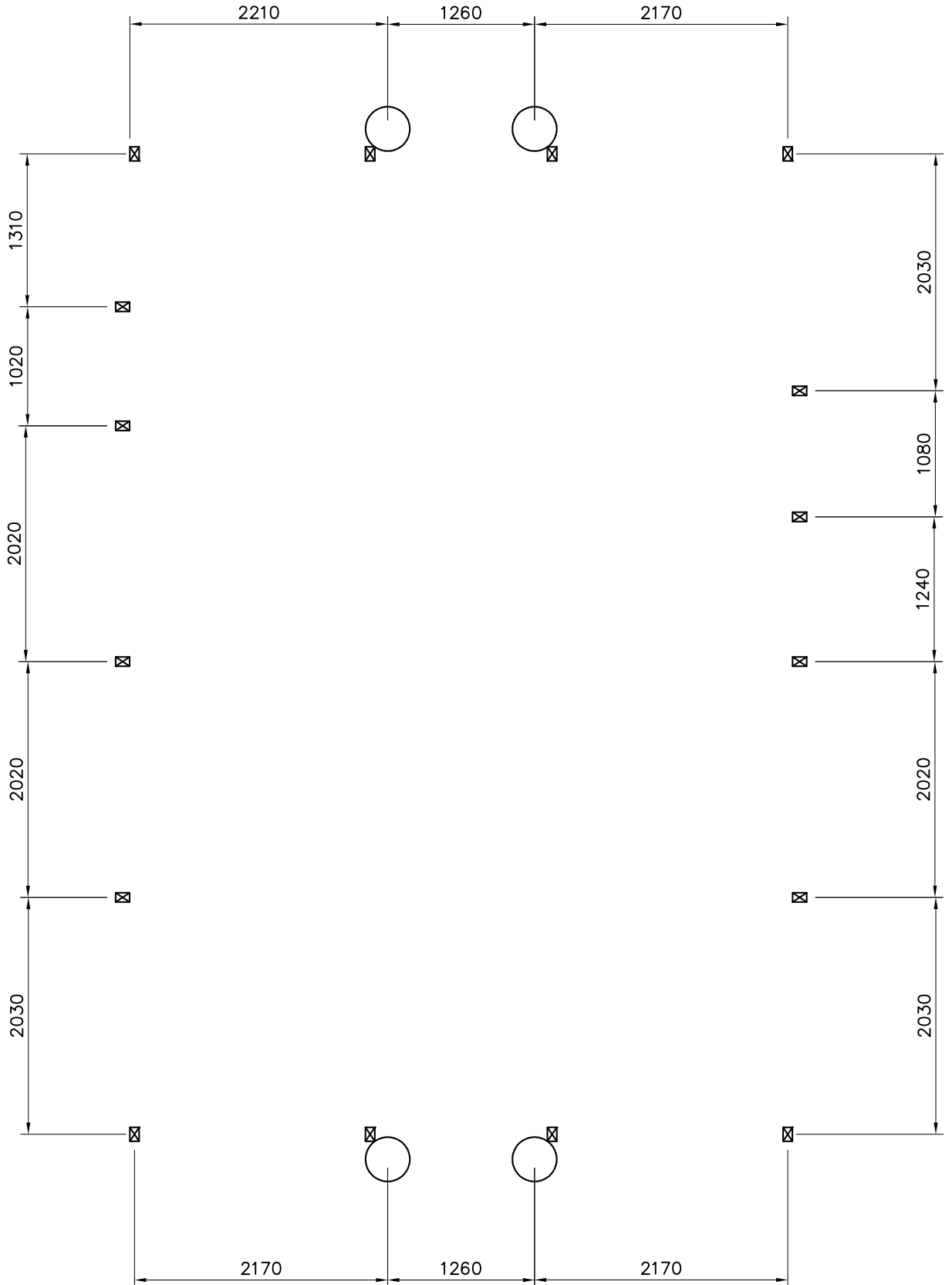
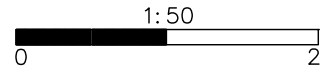

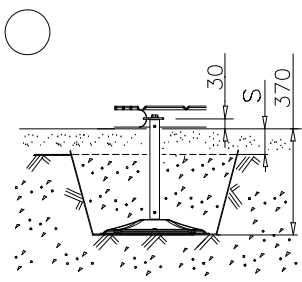
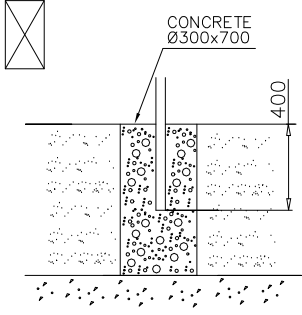

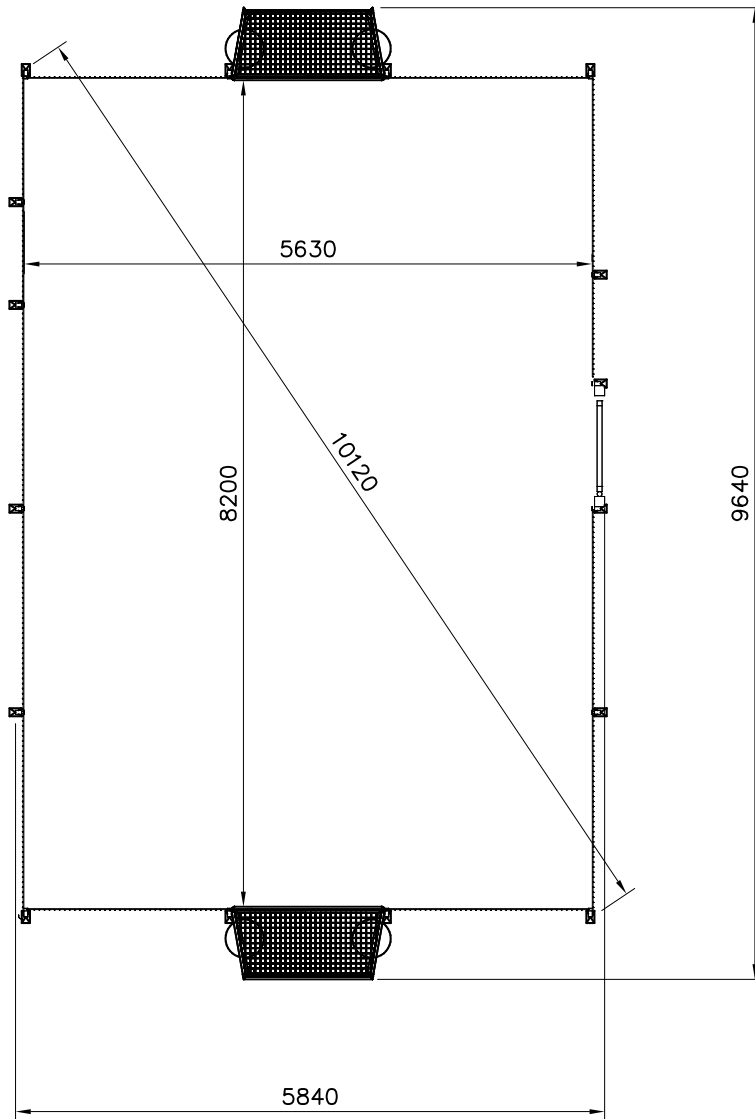
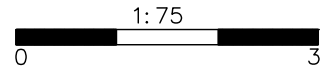

DATE: 16.3.2017

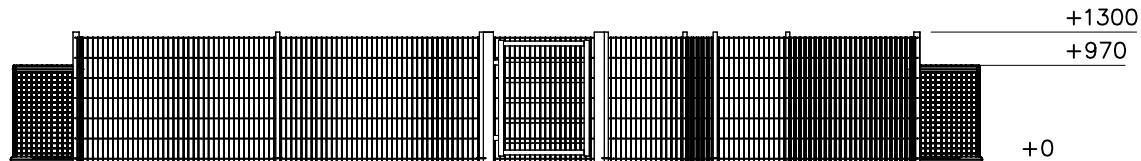
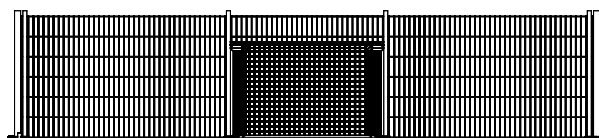

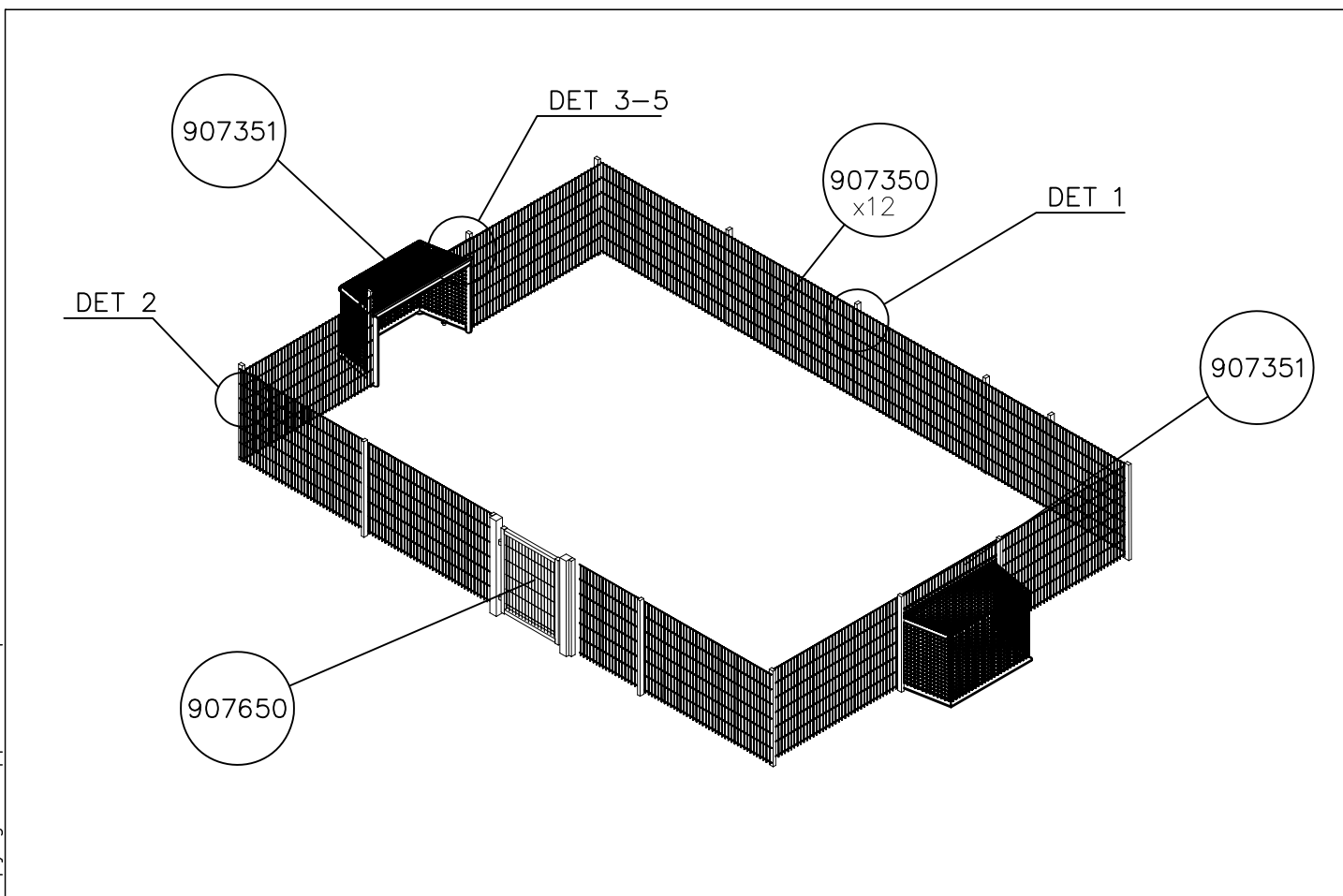
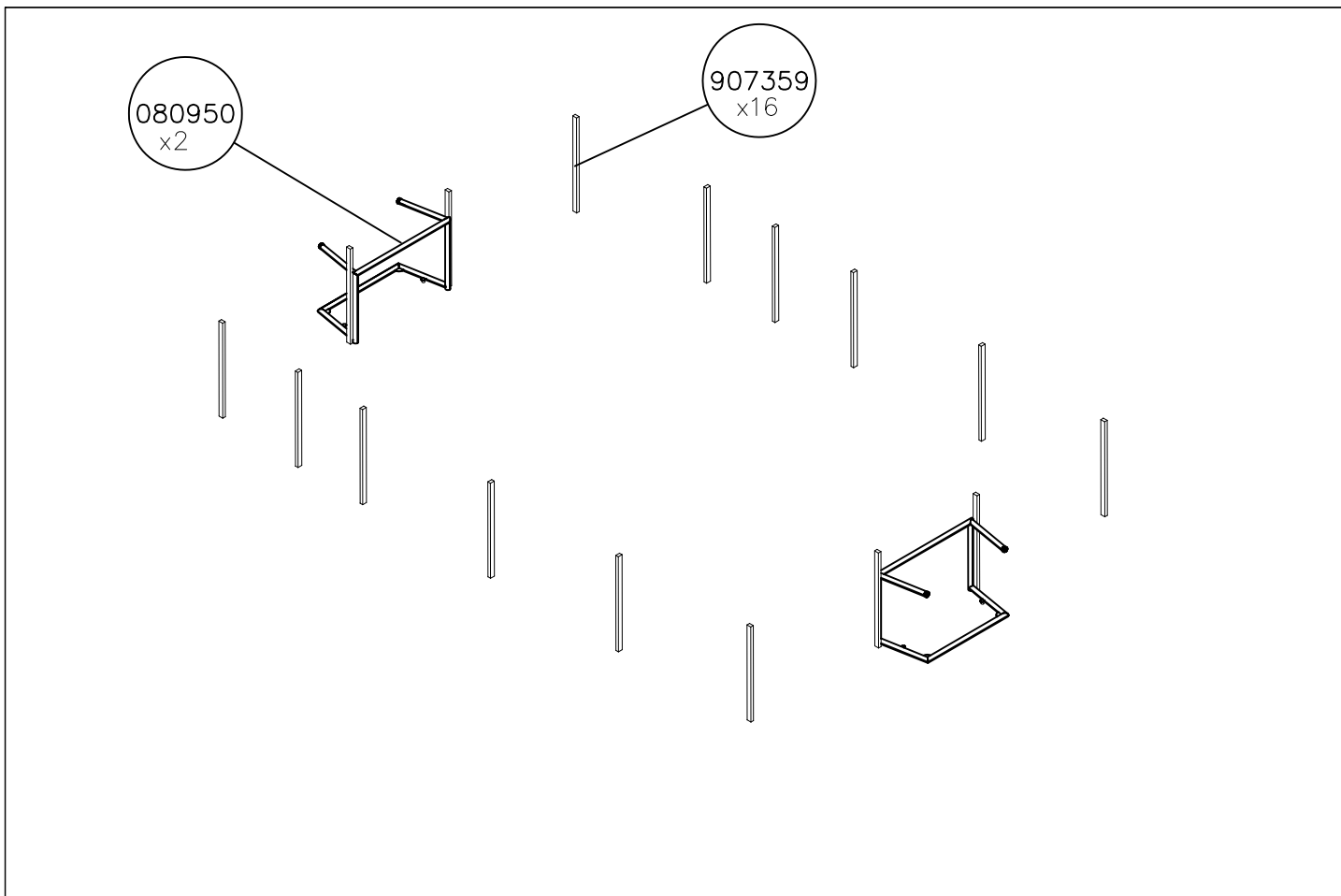

DATE: 16.3.2017

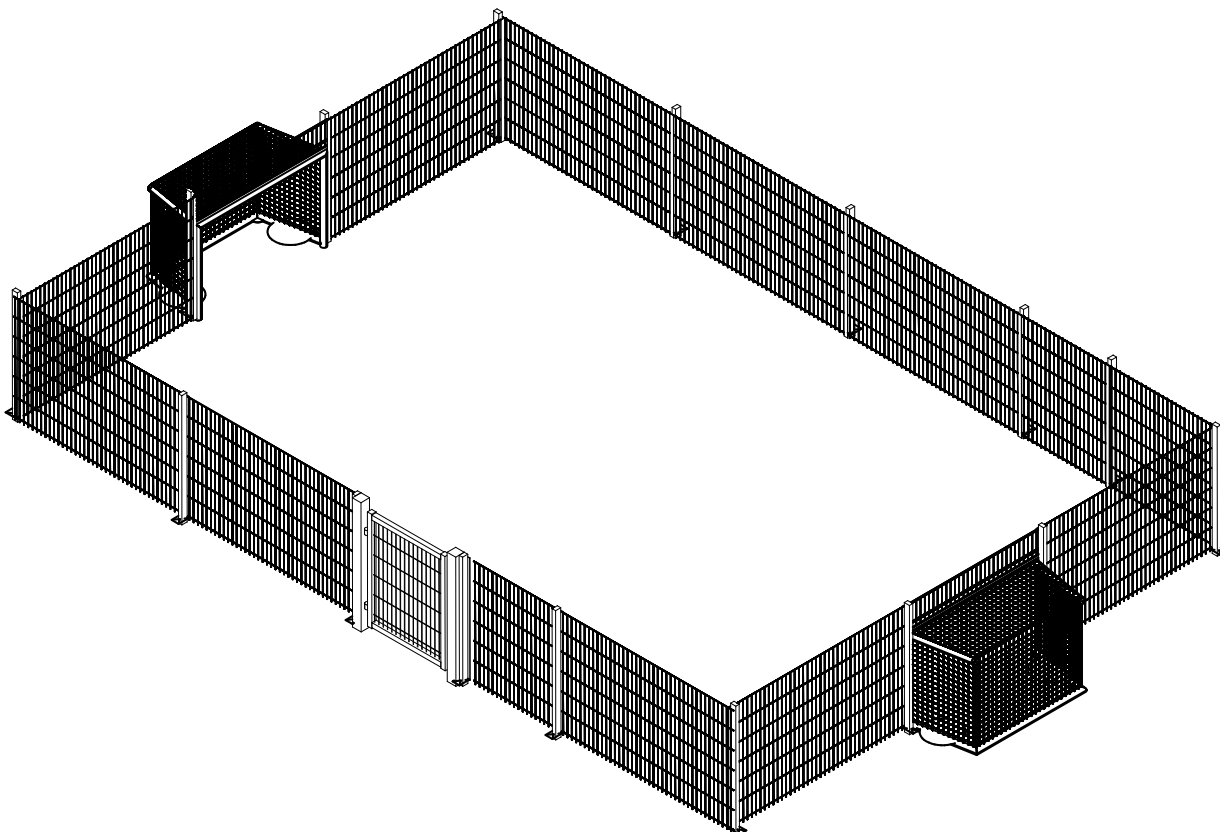
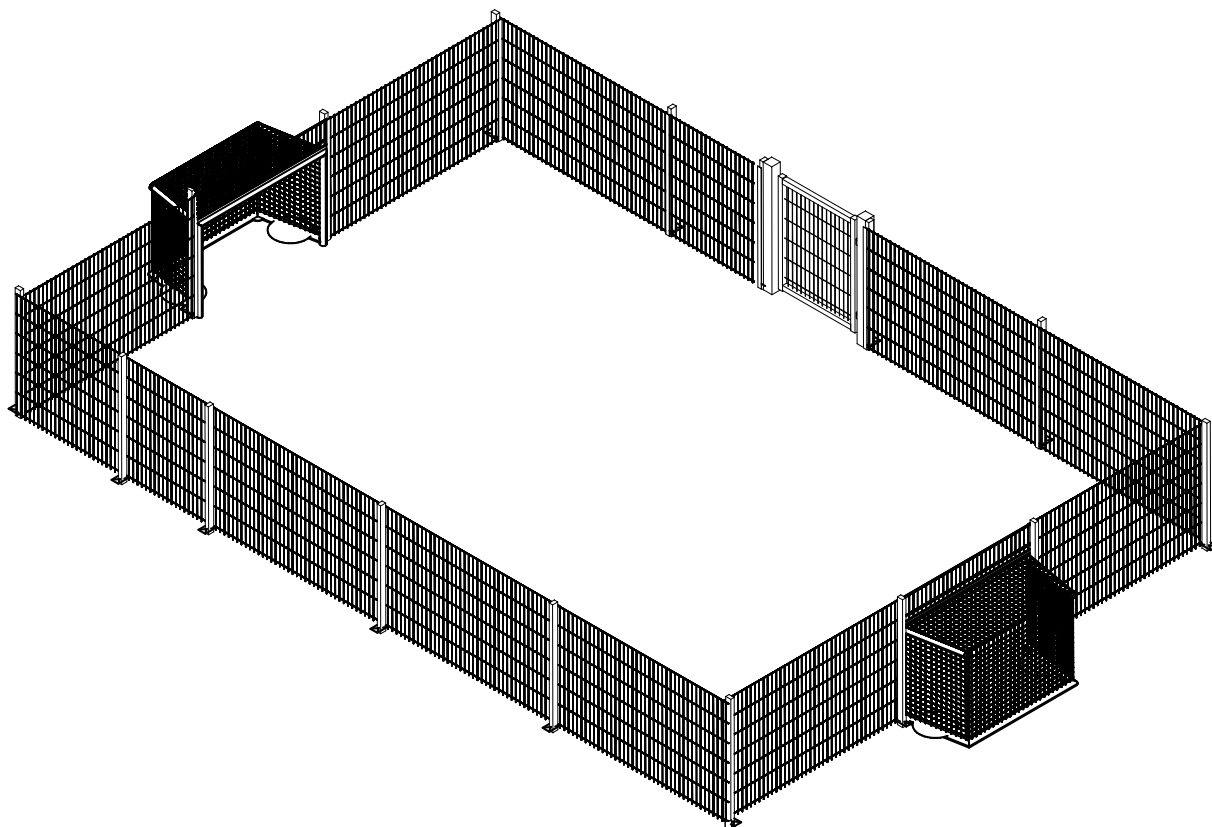

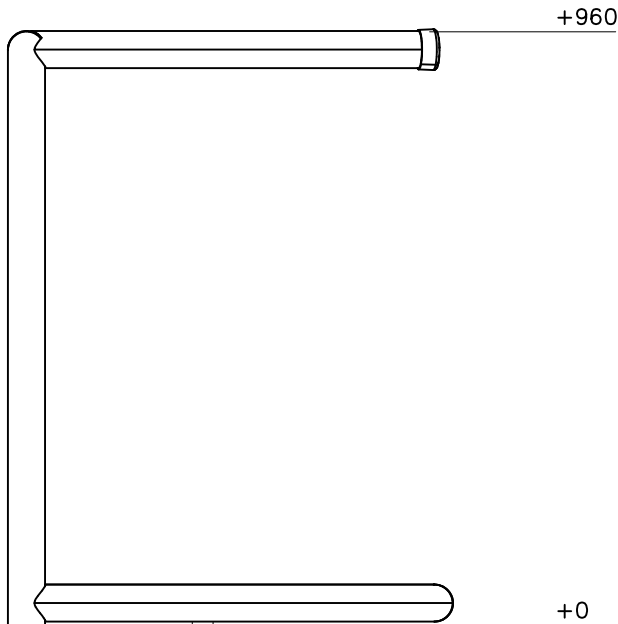
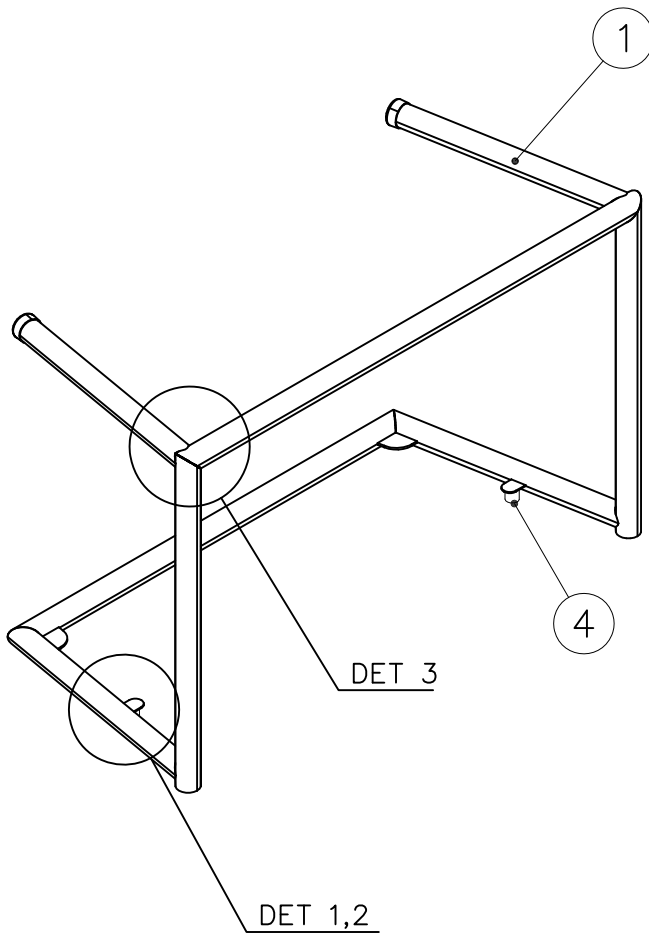

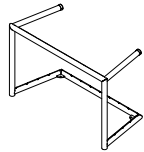
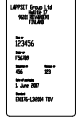
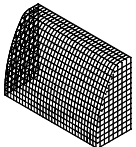
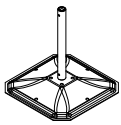
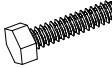

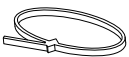
Part No.	PCS	Part No.	PCS
① 906776	1	② 702341	1
			
1520x950x720		90x50	
③ 906990	1	④ 705797	2
			
XS		L400	
⑤ 909214	2	⑥ 980154	2
			
M12x50		Ø24/13	
⑦ 907254	1	⑧ 904728	10
			
	PCS		PCS
	PCS		PCS
	PCS		PCS
	PCS		PCS

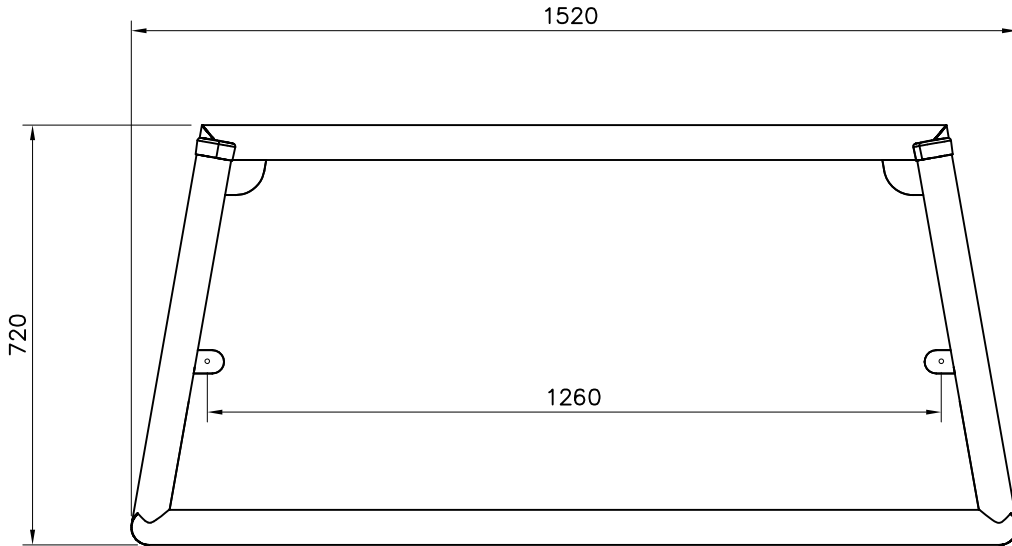

DET 1

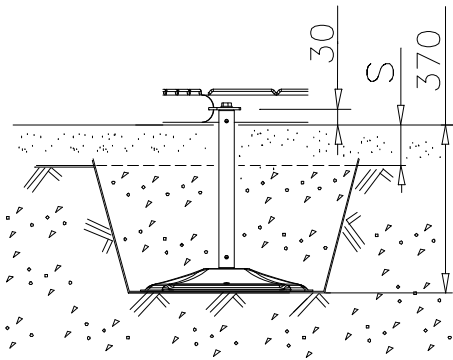

DET 2

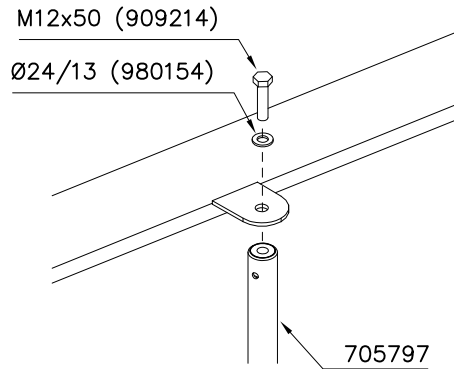

DET 3

Goal net needs to be fixed with an additional rope. Use cable ties to ease the fastening.

Maaliverkko kiinnitetään ylimääräisellä narulla. Käytä nippusiteitä kiinnittämisen apuna.

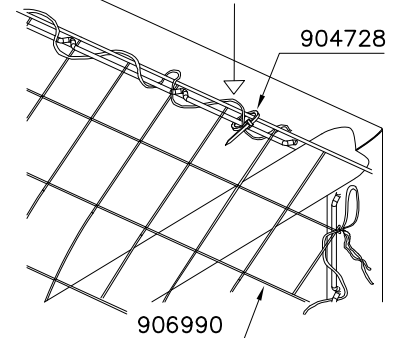

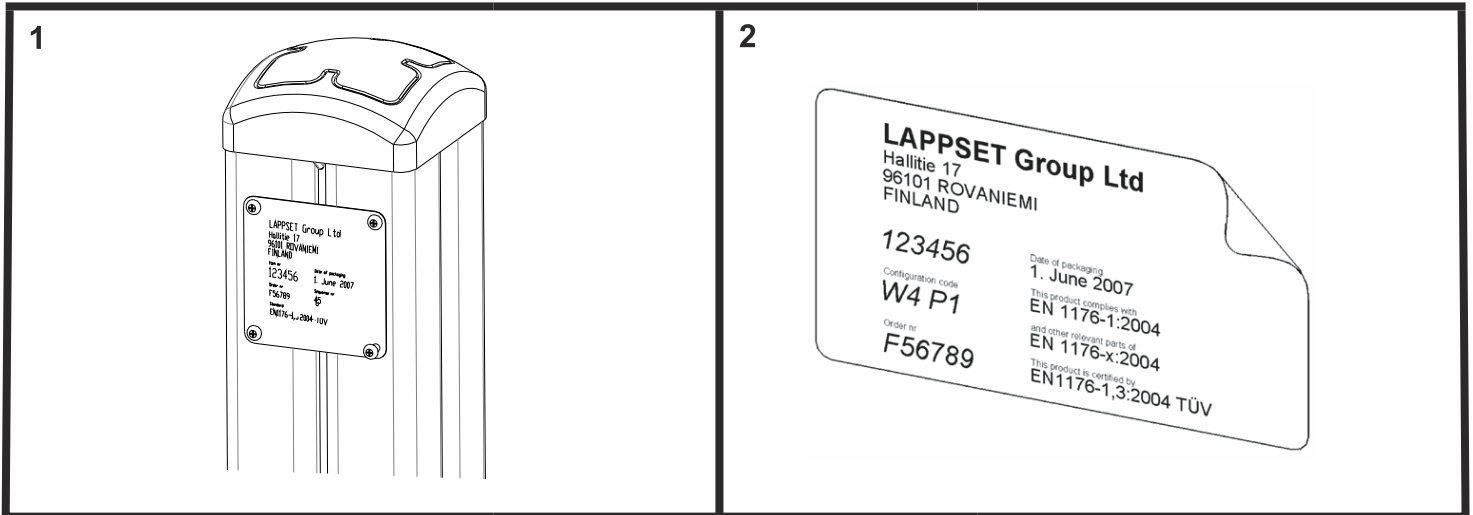
**Tuotekyltti tulee tuotteen mukana yhdellä seuraavista tavoista:****1) Metallinen tuotekyltti ja kiinnitysruuvit**

- Kiinnitä tuotekyltti ruuveilla tolppaan noin 2 metrin korkeuteen kuvan 1 mukaisesti.

2) Tuotekylttitarra

- Puhdista maalattu metalli- tai vaneripinta pölystä ja kosteudesta. Liimaa tarra kuvan 2 mukaisesti.
- Huom. Älä kiinnitä tarraa karheapintaiseen laminaattiin tai maalattuun puuhun.

Vår produktmärkning levereras på ett av följande sätt:**1) Produktskylt i metall**

- Fäst skylten med de medföljande skruvarna

2) Självhäftande produktetikett

- Rengör den pulverlackerade metallytan eller laminatyten så att den blir fri från smuts och fukt. Fäst etiketten enligt fig. 2.
- Obs! Fäst ej etiketten på detaljer med skrovlig yta eller på målat trä.

Product label is delivered by one of following ways:**1) Metal product label and screws**

- Fasten the label with screws.

2) Label sticker

- Clean the painted metal or plywood surface from dirt and moisture. Fasten the sticker as shown in the figure 2.
- Note. Do not attach the sticker to rough surfaced laminate or painted wood.

La plaque d'informations produit est livrée sous l'une de ces 3 formes :**1) Plaque métallique et vis**

- Fixez la plaque à l'aide des vis.

2) Etiquette autocollante

- Avant de coller l'étiquette, nettoyez le composant métallique peint ou la plaque de contreplaqué, de toute saleté. La surface doit être sèche (voir image 2).
- Attention, ne pas coller l'étiquette sur une surface lamellé-collée irrégulière ou sur du bois peint.

Die Auslieferung des Produktaufklebers erfolgt auf eine dieser Arten:**1) Produkt-Schild aus Metall incl. Schrauben**

- Die Befestigung des Schildes erfolgt mittels der Schrauben.

2) Aufkleber

- Entfernen Sie zunächst Schmutz und Feuchtigkeit vom lackierten Metall bzw. von der Holzoberfläche und bringen Sie den Aufkleber wie im Bild oben rechts beschrieben auf den gesäuberten Untergrund auf.
- Beachten Sie: Bringen Sie den Aufkleber nicht auf raues laminiertes oder lackiertes Holz an.