

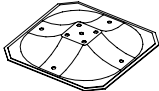



① 902094	PCS	② 909519	PCS
	1		1
Ø60x450		50x380x380	
③ 909637	PCS	④ 909638	PCS
	4		4
M10		Ø20/10,5	
⑤ 909639	PCS		PCS
	4		
M10x25			
	PCS		PCS
	PCS		PCS
	PCS		PCS

DET 1



DET 2

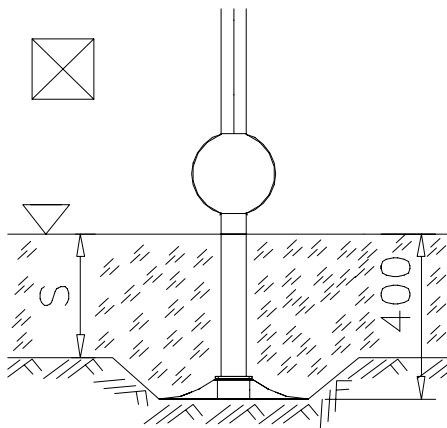
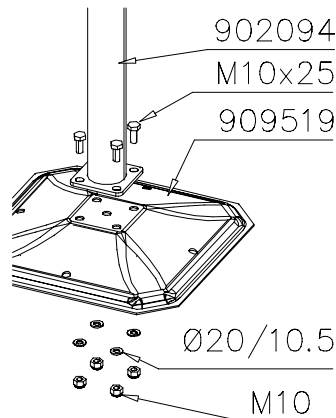



Tuotekyltti tulee tuotteen mukana yhdellä seuraavista tavoista:

1) Metallinen tuotekyltti ja kiinnitysruuvit

- Kiinnitä tuotekyltti ruuveilla tolppaan noin 2 metrin korkeuteen kuvan 1 mukaisesti.

2) Tuotekylttitarra

- Puhdista maalattu metalli- tai vaneripinta pölystä ja kosteudesta. Liimaa tarra kuvan 2 mukaisesti.
- Huom. Älä kiinnitä tarraa karheapintaiseen laminaattiin tai maalattuun puuhun.

Vår produktmärkning levereras på ett av följande sätt:

1) Produktskylt i metall

- Fäst skylten med de medföljande skruvarna

2) Självhäftande produktetikett

- Rengör den pulverlackerade metallytan eller laminatyten så att den blir fri från smuts och fukt. Fäst etiketten enligt fig. 2.
- Obs! Fäst ej etiketten på detaljer med skrovlig yta eller på målat trä.

Product label is delivered by one of following ways:

1) Metal product label and screws

- Fasten the label with screws.

2) Label sticker

- Clean the painted metal or plywood surface from dirt and moisture. Fasten the sticker as shown in the figure 2.
- Note. Do not attach the sticker to rough surfaced laminate or painted wood.

La plaque d'informations produit est livrée sous l'une de ces 3 formes :

1) Plaque métallique et vis

- Fixez la plaque à l'aide des vis.

2) Etiquette autocollante

- Avant de coller l'étiquette, nettoyez le composant métallique peint ou la plaque de contreplaqué, de toute saleté. La surface doit être sèche (voir image 2).
- Attention, ne pas coller l'étiquette sur une surface lamellé-collée irrégulière ou sur du bois peint.

Die Auslieferung des Produktaufklebers erfolgt auf eine dieser Arten:

1) Produkt-Schild aus Metall incl. Schrauben

- Die Befestigung des Schildes erfolgt mittels der Schrauben.

2) Aufkleber

- Entfernen Sie zunächst Schmutz und Feuchtigkeit vom lackierten Metall bzw. von der Holzoberfläche und bringen Sie den Aufkleber wie im Bild oben rechts beschrieben auf den gesäuberten Untergrund auf.
- Beachten Sie: Bringen Sie den Aufkleber nicht auf raues laminiertes oder lackiertes Holz an.

LAPPSET®

WALL

PARKOUR

DATE: 17.11.2010

1(2)

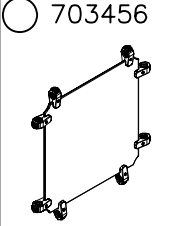
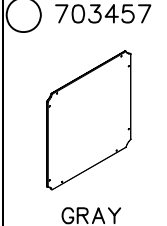
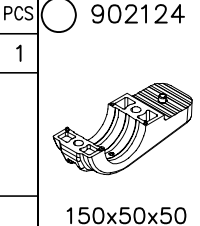
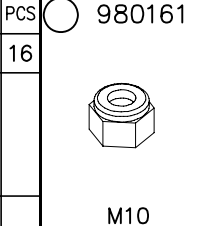
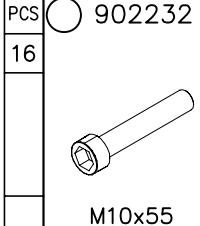
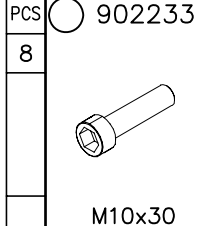
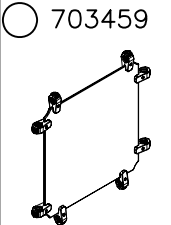
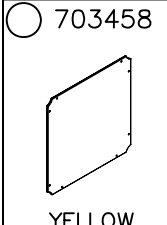
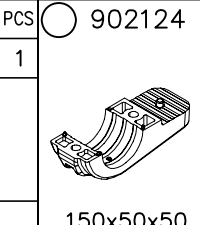
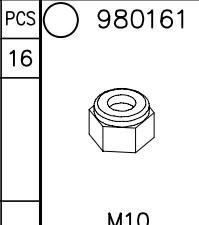
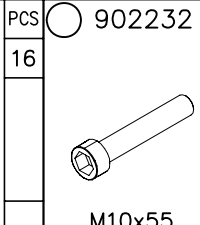
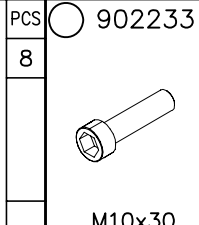
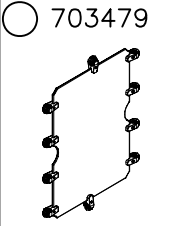
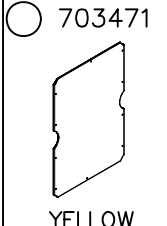
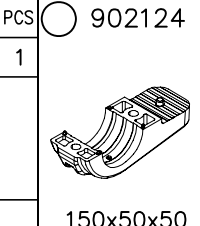
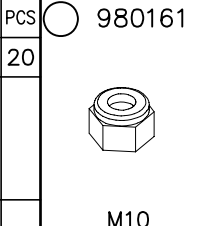
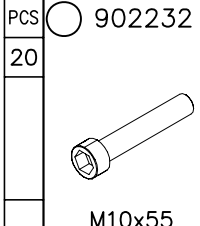
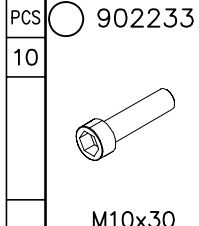
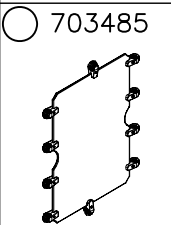
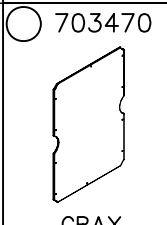
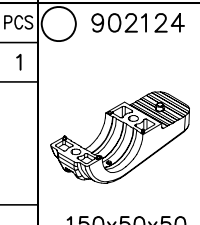
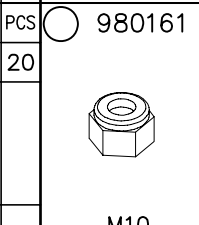
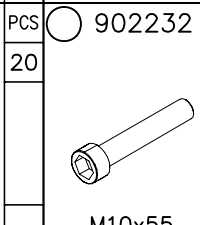
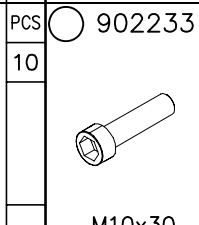
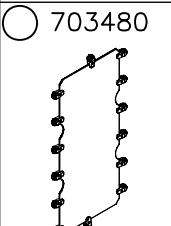
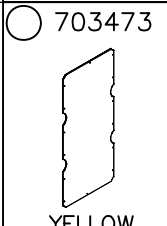
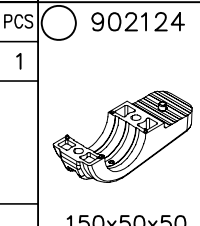
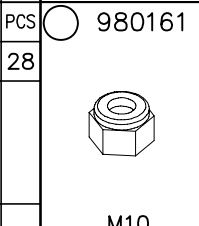
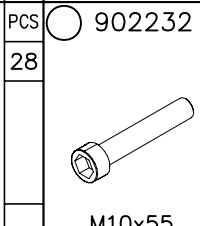
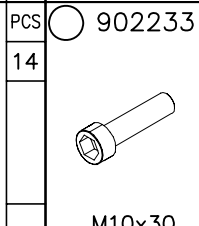
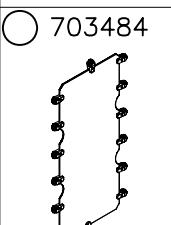
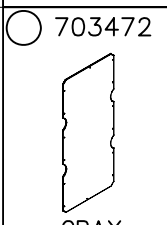
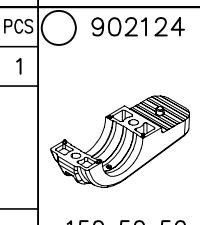
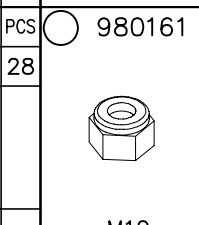
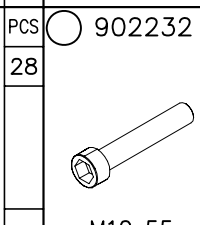
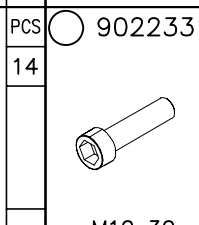
	 GRAY	PCS 1	 150x50x50	PCS 16	 M10	PCS 16	 M10x55	PCS 8	 M10x30	PCS 8		PCS
	 YELLOW	PCS 1	 150x50x50	PCS 16	 M10	PCS 16	 M10x55	PCS 8	 M10x30	PCS 8		PCS
		PCS		PCS		PCS		PCS		PCS		PCS
	 YELLOW	PCS 1	 150x50x50	PCS 20	 M10	PCS 20	 M10x55	PCS 10	 M10x30	PCS 10		PCS
	 GRAY	PCS 1	 150x50x50	PCS 20	 M10	PCS 20	 M10x55	PCS 10	 M10x30	PCS 10		PCS
		PCS		PCS		PCS		PCS		PCS		PCS
	 YELLOW	PCS 1	 150x50x50	PCS 28	 M10	PCS 28	 M10x55	PCS 14	 M10x30	PCS 14		PCS
	 GRAY	PCS 1	 150x50x50	PCS 28	 M10	PCS 28	 M10x55	PCS 14	 M10x30	PCS 14		PCS

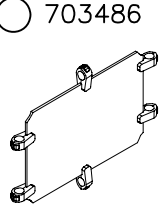
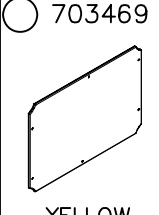
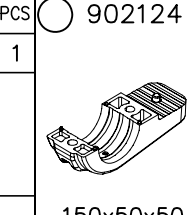
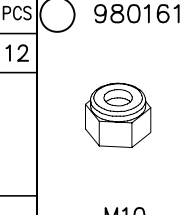
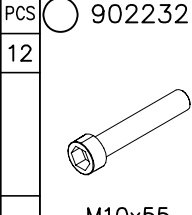
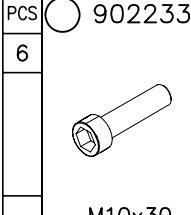
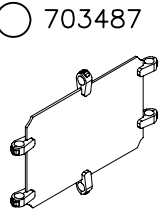
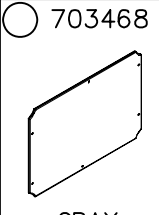
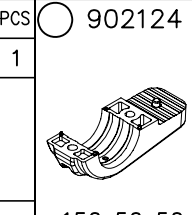
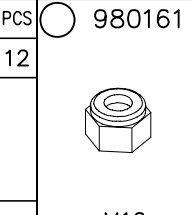
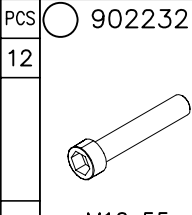
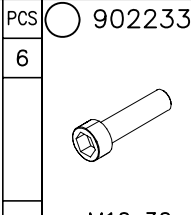
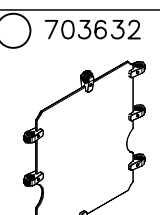
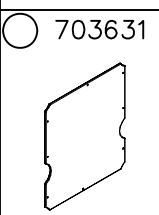
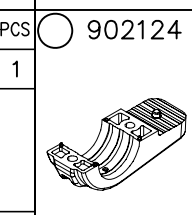
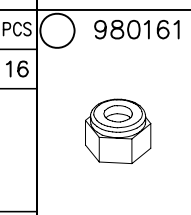
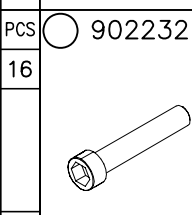
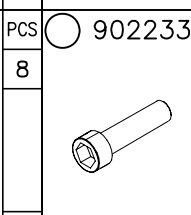
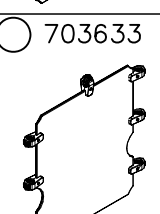
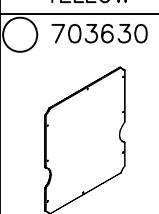
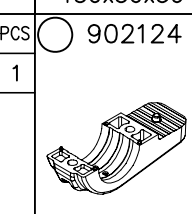
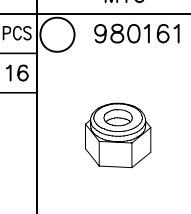
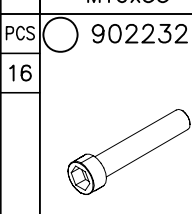
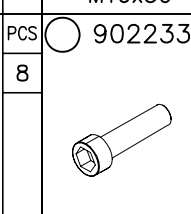
 <p>703486</p>	 <p>703469 YELLOW</p>	<p>PCS</p> <p>1</p>	 <p>902124 150x50x50</p>	<p>PCS</p> <p>12</p>	 <p>980161 M10</p>	<p>PCS</p> <p>12</p>	 <p>902232 M10x55</p>	<p>PCS</p> <p>6</p>	 <p>902233 M10x30</p>	<p>PCS</p> <p>6</p>		<p>PCS</p>
 <p>703487</p>	 <p>703468 GRAY</p>	<p>PCS</p> <p>1</p>	 <p>902124 150x50x50</p>	<p>PCS</p> <p>12</p>	 <p>980161 M10</p>	<p>PCS</p> <p>12</p>	 <p>902232 M10x55</p>	<p>PCS</p> <p>6</p>	 <p>902233 M10x30</p>	<p>PCS</p> <p>6</p>		<p>PCS</p>
		<p>PCS</p>		<p>PCS</p>		<p>PCS</p>		<p>PCS</p>		<p>PCS</p>		<p>PCS</p>
 <p>703632</p>	 <p>703631 YELLOW</p>	<p>PCS</p> <p>1</p>	 <p>902124 150x50x50</p>	<p>PCS</p> <p>16</p>	 <p>980161 M10</p>	<p>PCS</p> <p>16</p>	 <p>902232 M10x55</p>	<p>PCS</p> <p>8</p>	 <p>902233 M10x30</p>	<p>PCS</p> <p>8</p>		<p>PCS</p>
 <p>703633</p>	 <p>703630 GRAY</p>	<p>PCS</p> <p>1</p>	 <p>902124 150x50x50</p>	<p>PCS</p> <p>16</p>	 <p>980161 M10</p>	<p>PCS</p> <p>16</p>	 <p>902232 M10x55</p>	<p>PCS</p> <p>8</p>	 <p>902233 M10x30</p>	<p>PCS</p> <p>8</p>		<p>PCS</p>
		<p>PCS</p>		<p>PCS</p>		<p>PCS</p>		<p>PCS</p>		<p>PCS</p>		<p>PCS</p>

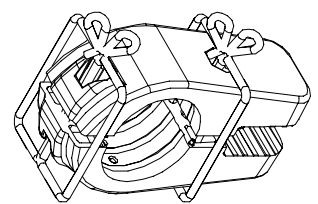
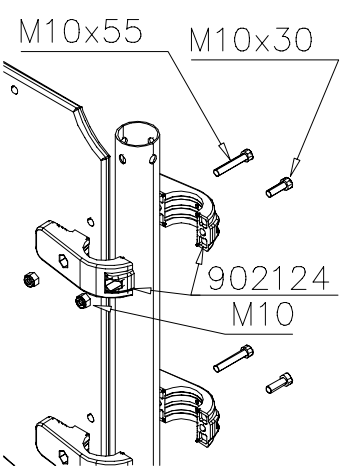
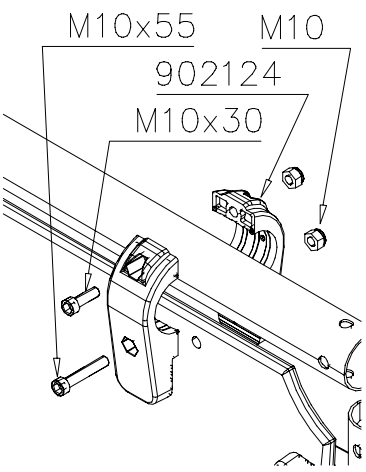



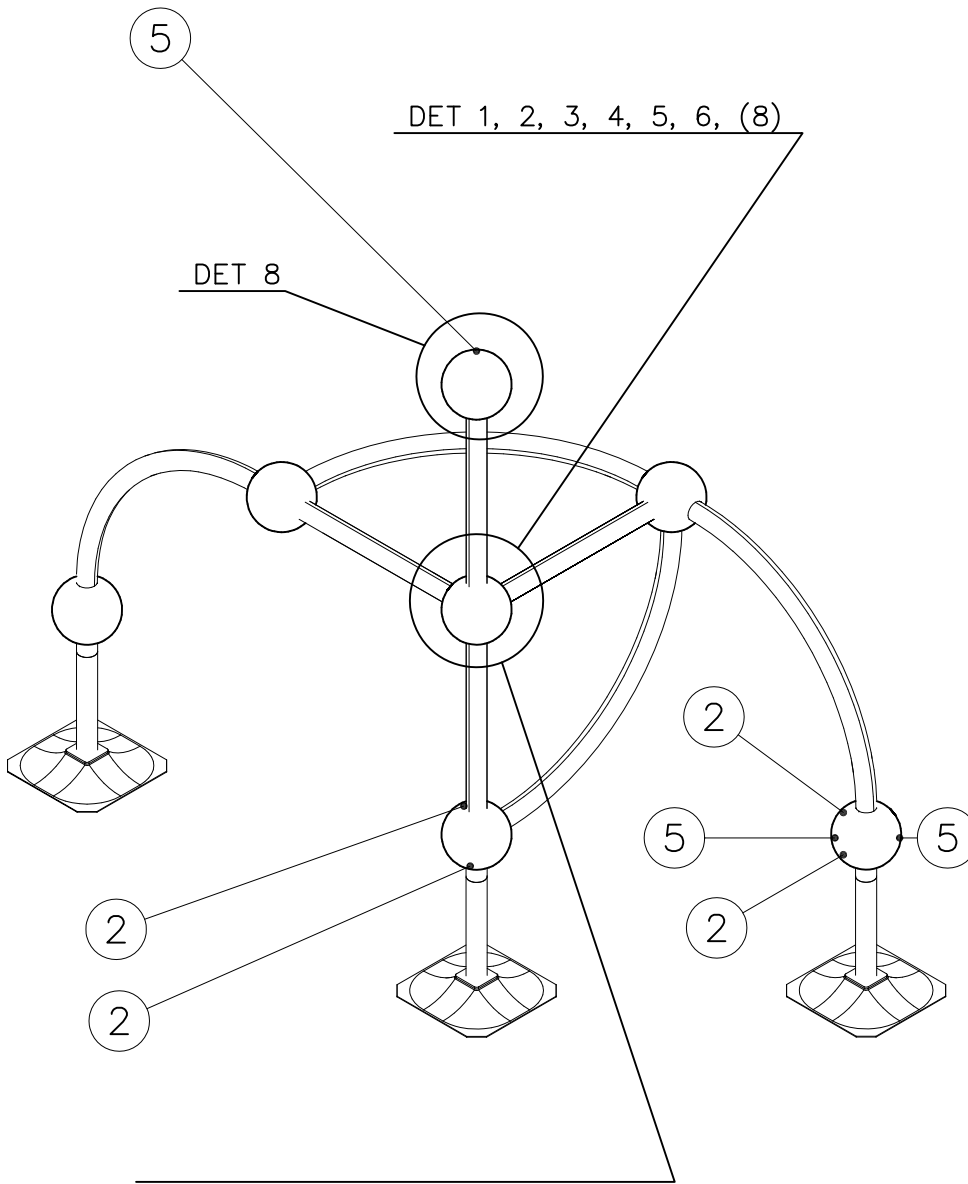

NOTE:
Use a wire marked pairs
of the same junction.

Huom!
Käytä langalla merkittyä
paria samassa liitoksessa.

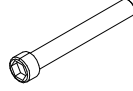

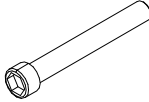
DO NOT TIGHTEN THE JOINTS UNTIL THE STRUCTURE IS COMPLETE.

① 901803	PCS	② 901994	PCS
	2		2
M12x90		Ø190	
③ 902096	PCS	④ 902234	PCS
	4		6
M12x120		M12	
	PCS		PCS
	PCS		PCS
	PCS		PCS
	PCS		PCS
	PCS		PCS
	PCS		PCS

DET 1

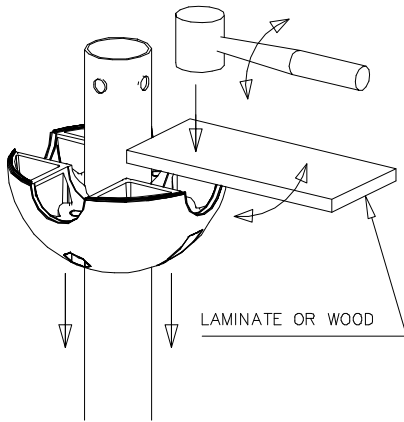

DET 2

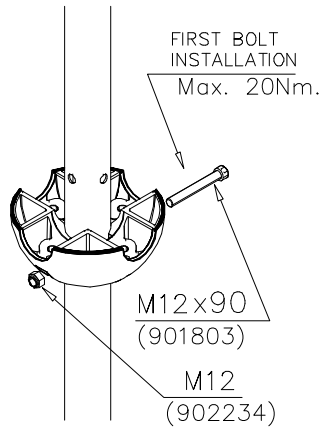

DET 3

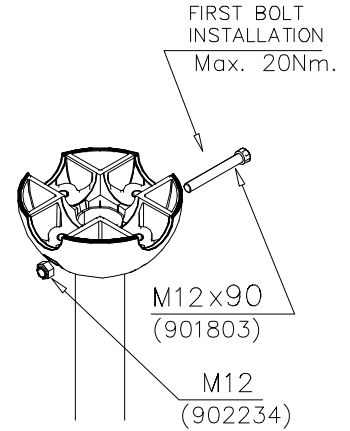

DET 4

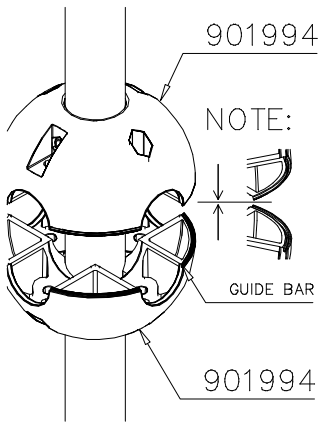

DET 5

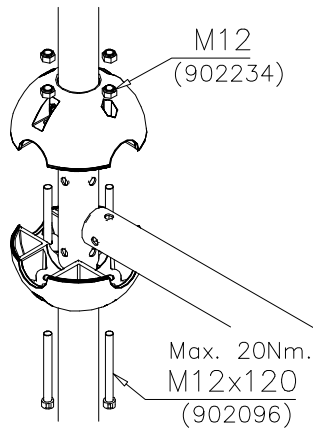

DET 6

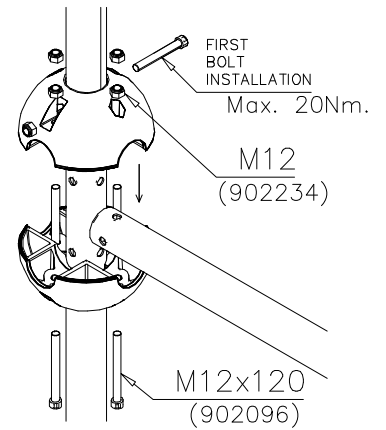

REMEMBER
FINAL
TIGHTENING

DET 7

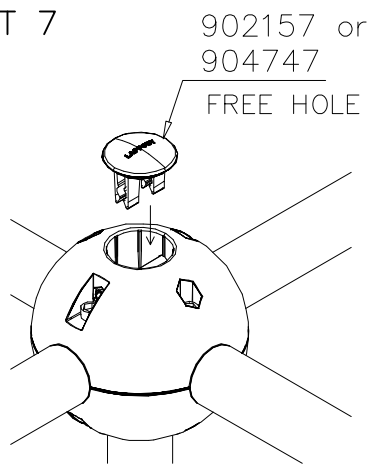

DET 8

