

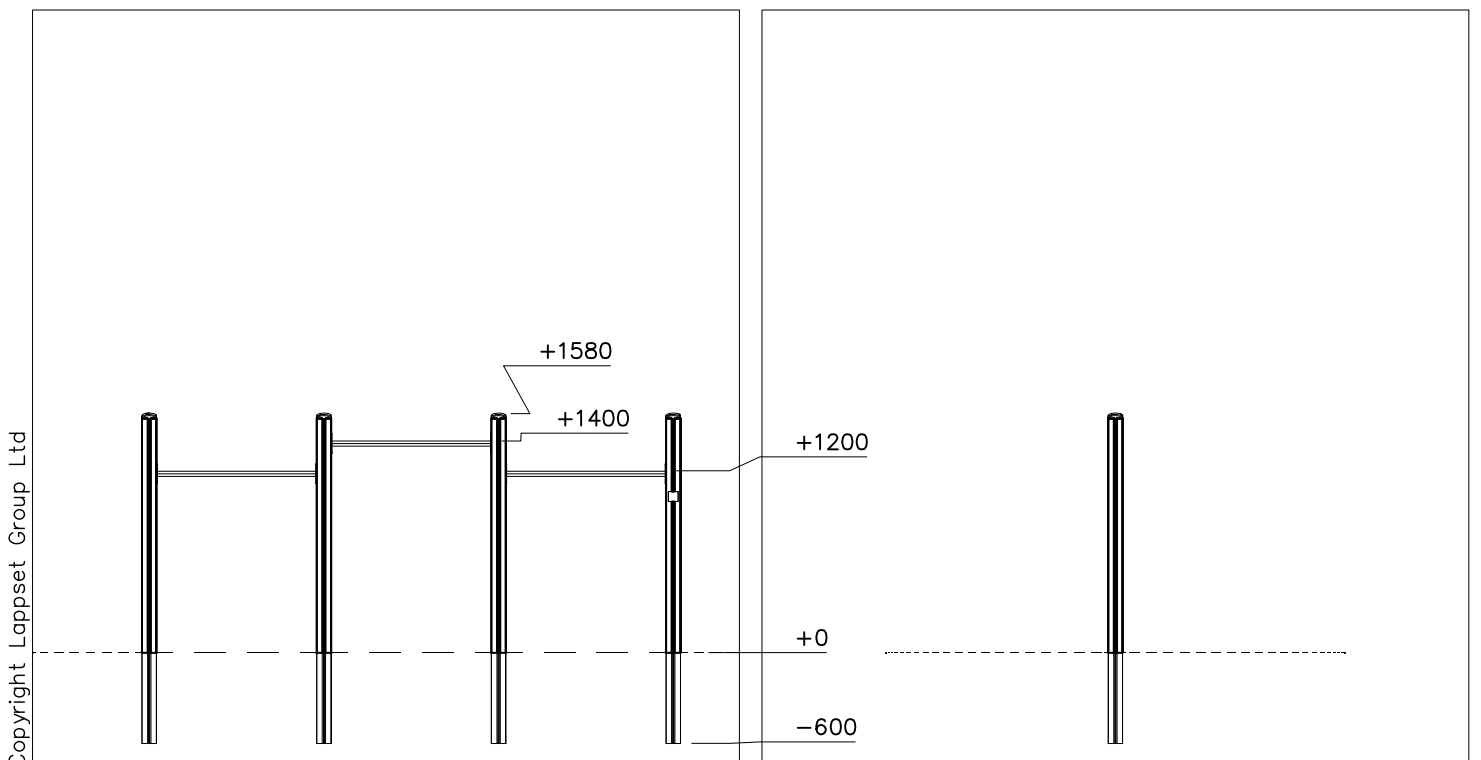

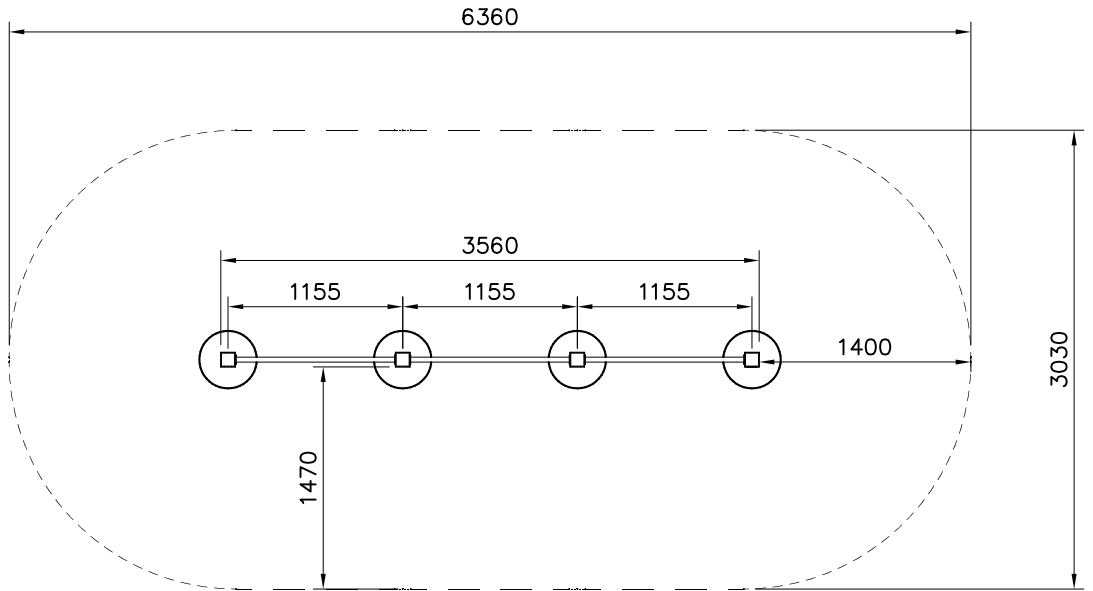

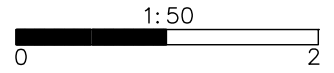



— EN/AS Impact Area 17.4 m²
 - - - Falling Space 17.4 m²
 Max Falling Height 1400 mm

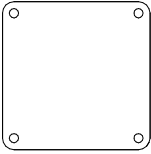
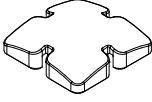
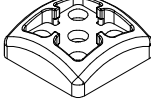

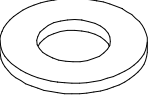
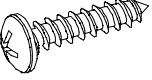
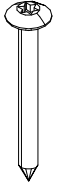
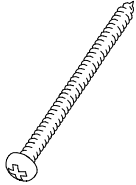
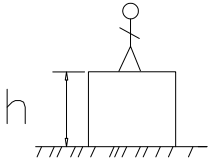
DATE: 8.12.2015

702286  90x50	PCS 1	706484-602  93x93x2150	PCS 4	902487  65x65	PCS 1	905138  GRAY	PCS 4	905196  GRAY	PCS 4	905838-216  L 1060	PCS 3
909256  Ø16/8.4	PCS 24	909506  Ø3.5x13	PCS 4	980123  Ø7x60	PCS 24	980131  Ø6x60	PCS 16		PCS		PCS
	PCS		PCS		PCS		PCS		PCS		PCS
	PCS		PCS		PCS		PCS		PCS		PCS
	PCS		PCS		PCS		PCS		PCS		PCS
	PCS		PCS		PCS		PCS		PCS		PCS
	PCS		PCS		PCS		PCS		PCS		PCS

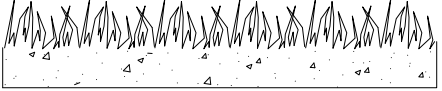
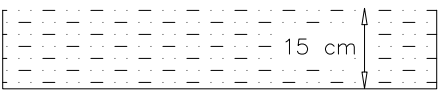
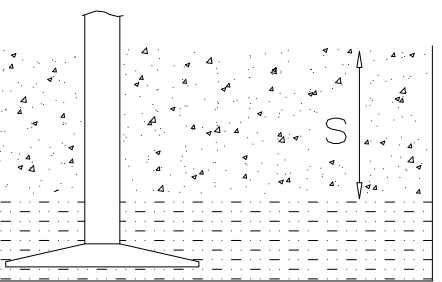
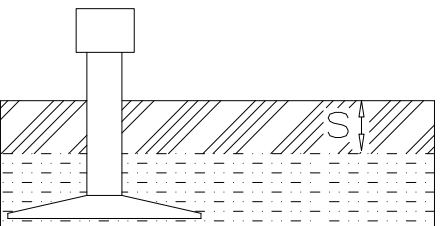
		
<p>$h < 600$</p> <p>Without movement and therefore without Impact Area</p>	<p>Totally hard surfaces.</p> <p>Note. Lappset does <u>not recommend</u> totally hard surfaces at all.</p>	<p>E.g. concrete or asphalt</p> 
<p>$h < 600$</p> <p>With movement e.g. rocking</p>	<p>Materials with very limited impact attenuating properties.</p>	<p>E.g. wood</p> 
<p>$h < 1000$</p>	<p>Materials with significant impact attenuating properties.</p>	<p>fine gravel 0–8 mm</p>  <p>grass</p>  <p>unsorted sand</p> 
<p>$h < 3000$</p>	<p>Loose fill material</p> <p>E.g. sand/gravel 0,25...8 mm D60/D10<3,0 Woodchips 5...30 mm bark 20...80 mm</p>	 <p>\underline{S} \underline{h}</p> <p>30 cm < 2,0 m</p> <p>40 cm < 3,0 m</p>
	<p>Syntethic granulates</p> <p>\underline{S} \underline{h}</p> <p>40 mm ~> 1,2...1,3 m</p> <p>50 mm ~> 1,5...1,7 m</p> <p>60 mm ~> 1,8...2,0 m</p> <p>70 mm ~> 2,1...2,5 m</p> <p>Note. For accurate values, see manufacturer's instructions.</p>	

REMOVE SAFETY SURFACE/SAND/GRAVEL
TO CHECK FOUNDATION



REMOVE SAFETY SURFACE/SAND/GRAVEL
TO CHECK FOUNDATION





Tuotekyltti tulee tuotteen mukana yhdellä seuraavista tavoista:

1) Metallinen tuotekyltti ja kiinnitysruuvit

- Kiinnitä tuotekyltti ruuveilla tolppaan noin 2 metrin korkeuteen kuvan 1 mukaisesti.

2) Tuotekylttitarra

- Puhdista maalattu metalli- tai vaneripinta pölystä ja kosteudesta. Liimaa tarra kuvan 2 mukaisesti.
- Huom. Älä kiinnitä tarraa karheapintaiseen laminaattiin tai maalattuun puuhun.

Vår produktmärkning levereras på ett av följande sätt:

1) Produktskylt i metall

- Fäst skylten med de medföljande skruvarna

2) Självhäftande produktetikett

- Rengör den pulverlackerade metallytan eller laminatyten så att den blir fri från smuts och fukt. Fäst etiketten enligt fig. 2.
- Obs! Fäst ej etiketten på detaljer med skrovlig yta eller på målat trä.

Product label is delivered by one of following ways:

1) Metal product label and screws

- Fasten the label with screws.

2) Label sticker

- Clean the painted metal or plywood surface from dirt and moisture. Fasten the sticker as shown in the figure 2.
- Note. Do not attach the sticker to rough surfaced laminate or painted wood.

La plaque d'informations produit est livrée sous l'une de ces 3 formes :

1) Plaque métallique et vis

- Fixez la plaque à l'aide des vis.

2) Etiquette autocollante

- Avant de coller l'étiquette, nettoyez le composant métallique peint ou la plaque de contreplaqué, de toute saleté. La surface doit être sèche (voir image 2).
- Attention, ne pas coller l'étiquette sur une surface lamellé-collée irrégulière ou sur du bois peint.

Die Auslieferung des Produktaufklebers erfolgt auf eine dieser Arten:

1) Produkt-Schild aus Metall incl. Schrauben

- Die Befestigung des Schildes erfolgt mittels der Schrauben.

2) Aufkleber

- Entfernen Sie zunächst Schmutz und Feuchtigkeit vom lackierten Metall bzw. von der Holzoberfläche und bringen Sie den Aufkleber wie im Bild oben rechts beschrieben auf den gesäuberten Untergrund auf.
- Beachten Sie: Bringen Sie den Aufkleber nicht auf raues laminiertes oder lackiertes Holz an.