

LAPPSET®

ARC-SPORT





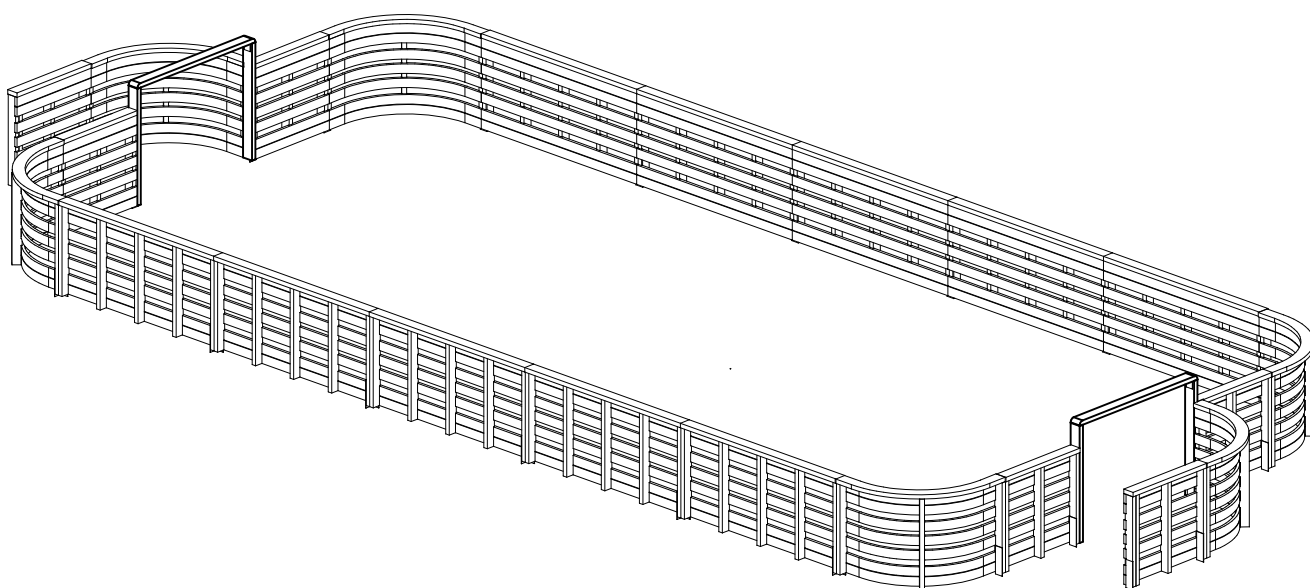

ASENNUSOHJE
MONTERINGSANSVISNING
INSTALLATION INSTRUCTION
AUFBAUANLEITUNG
NOTICE D'INSTALLATION

DATE: 30.6.2023

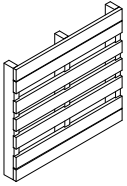
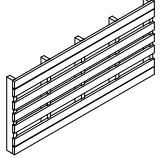
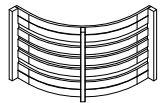
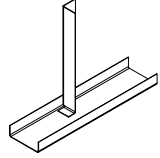
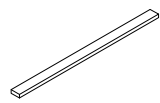
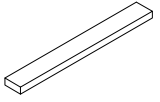
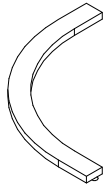
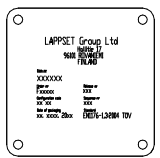
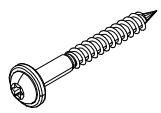
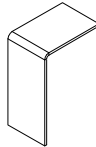
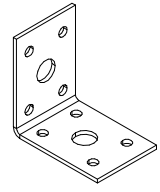
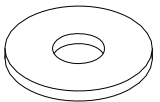
Q05487

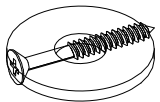
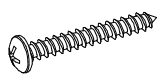
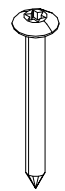
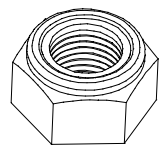

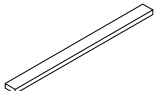
DATE: 30.6.2023

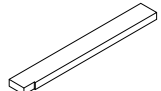
702018  L 910	PCS 2	702019  L 1000	PCS 6	702021  L 2000	PCS 10	702038  702038	PCS 6	702220  702220	PCS 24	702227  L 2000	PCS 10
702228  L 1000	PCS 4	702248  702248	PCS 6	702286  LAPPSET Group Ltd 65x65	PCS 1	900240  Ø8x70	PCS 12	902432  902432	PCS 4	902434  902434	PCS 60
905051  Ø24/8.4	PCS 186	909203  M8x75	PCS 90	980103  Ø4x50	PCS 8	980114  Ø4x20	PCS 4	980128  Ø7x40	PCS 148	980150  M8	PCS 90
P00739  45x115x1175	PCS 2	P00740  45x115x1590	PCS 2	P00741  45x115x1175	PCS 2	P00742  L 1000	PCS 2		PCS		PCS
	PCS		PCS		PCS		PCS		PCS		PCS
	PCS		PCS		PCS		PCS		PCS		PCS
	PCS		PCS		PCS		PCS		PCS		PCS



Grid size = 1000 mm.

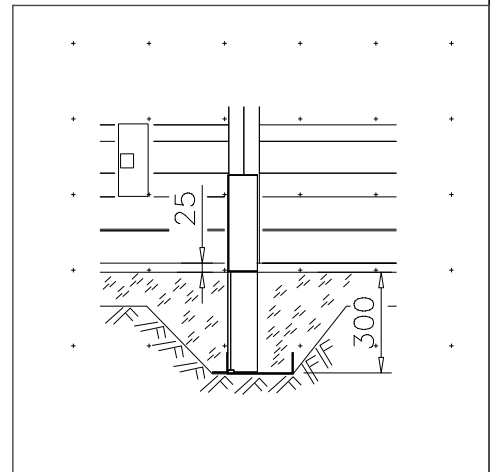
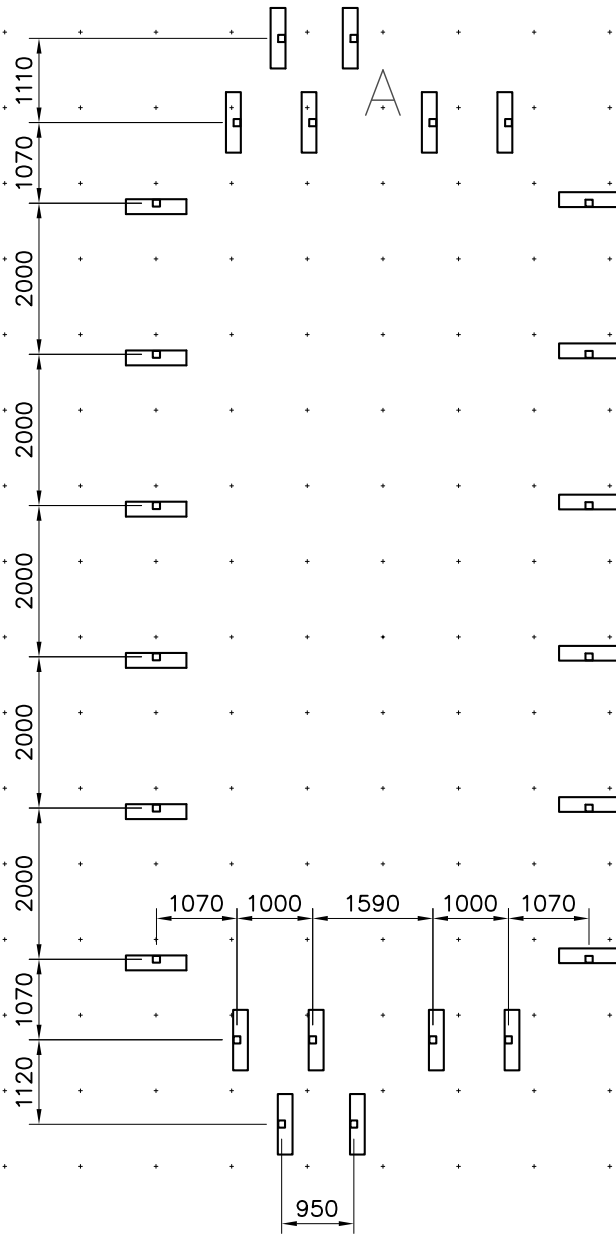

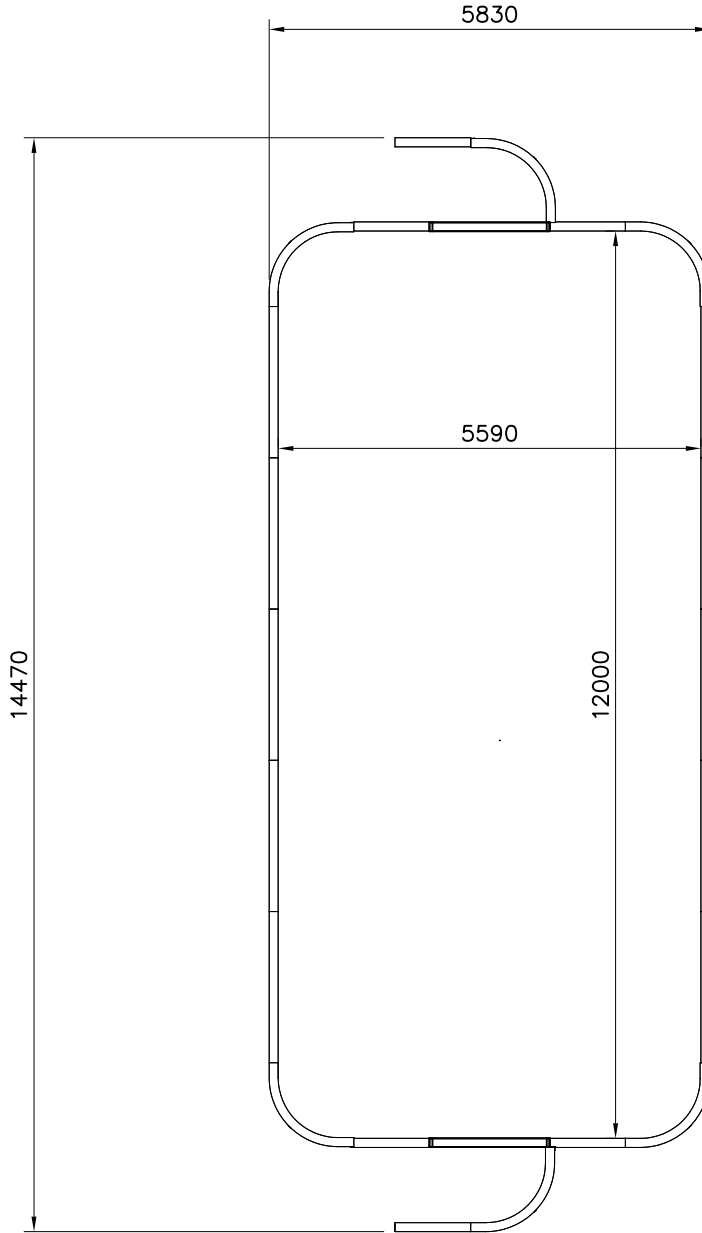
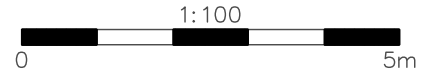

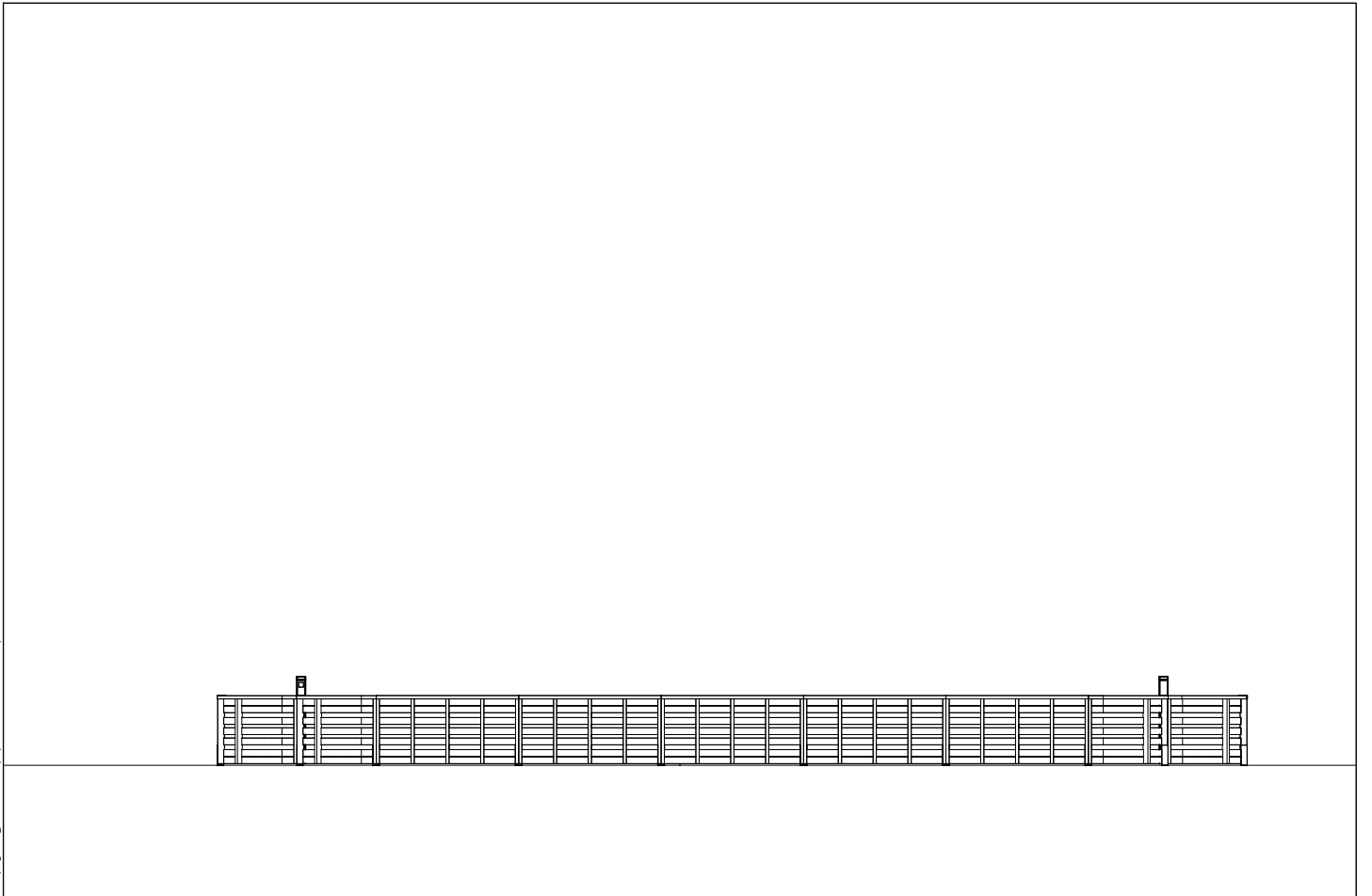
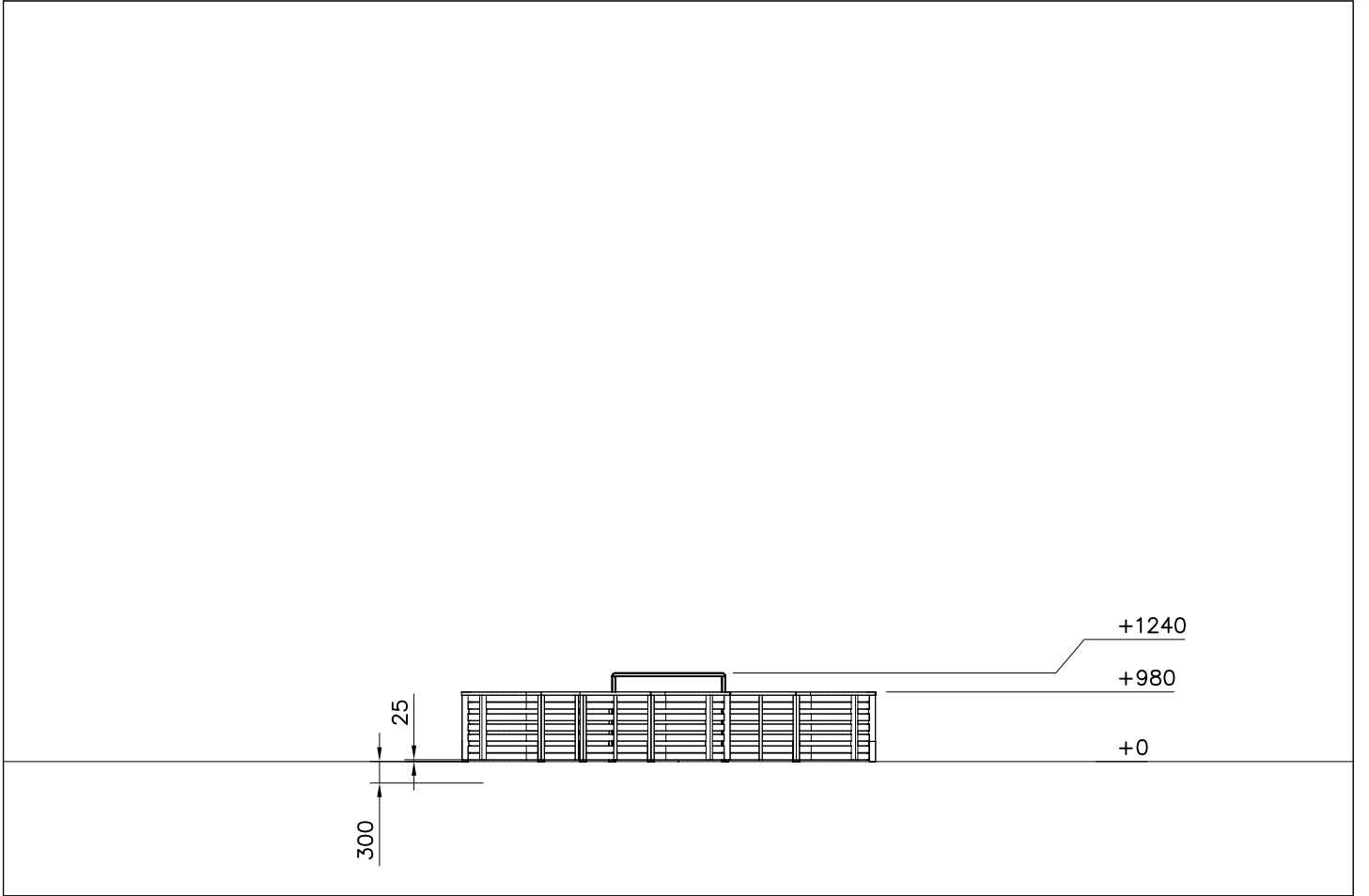

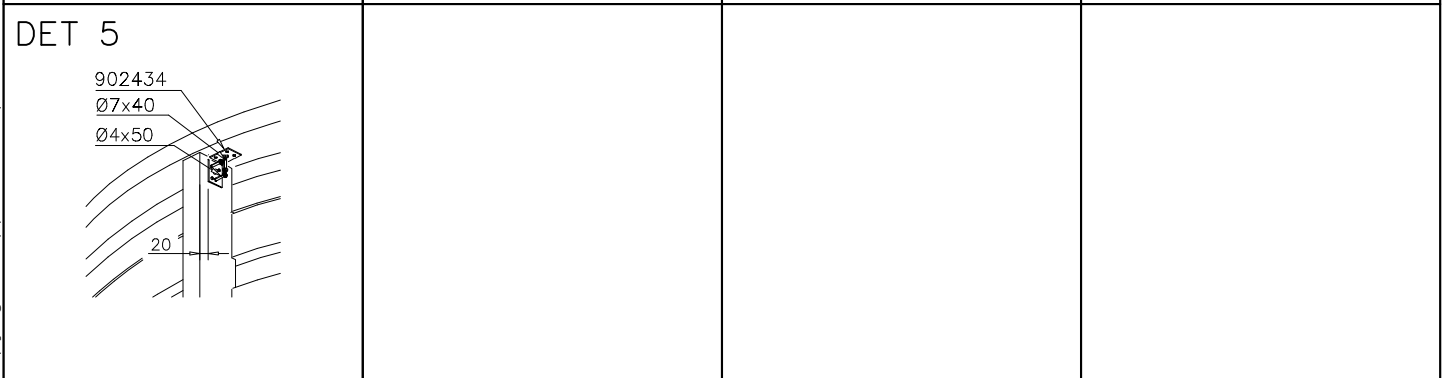
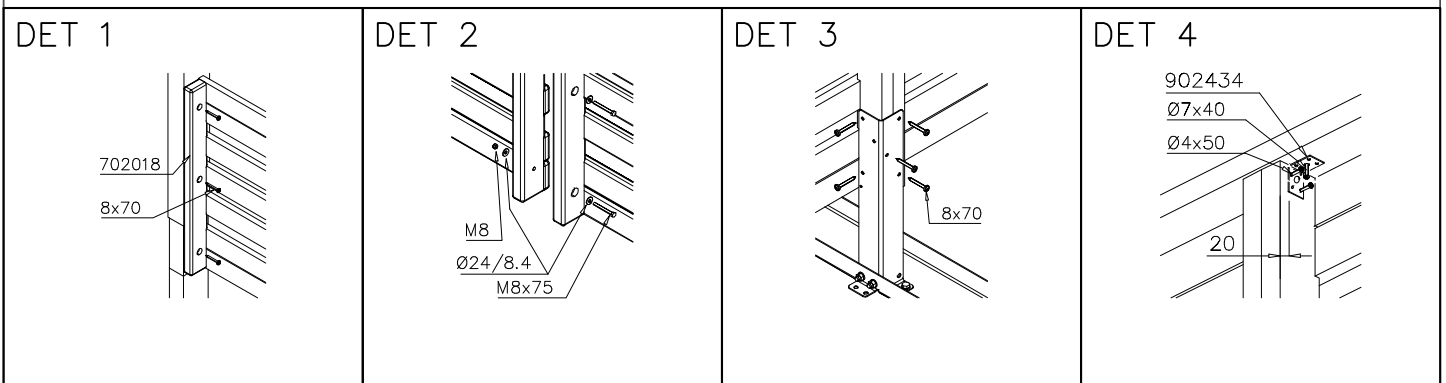
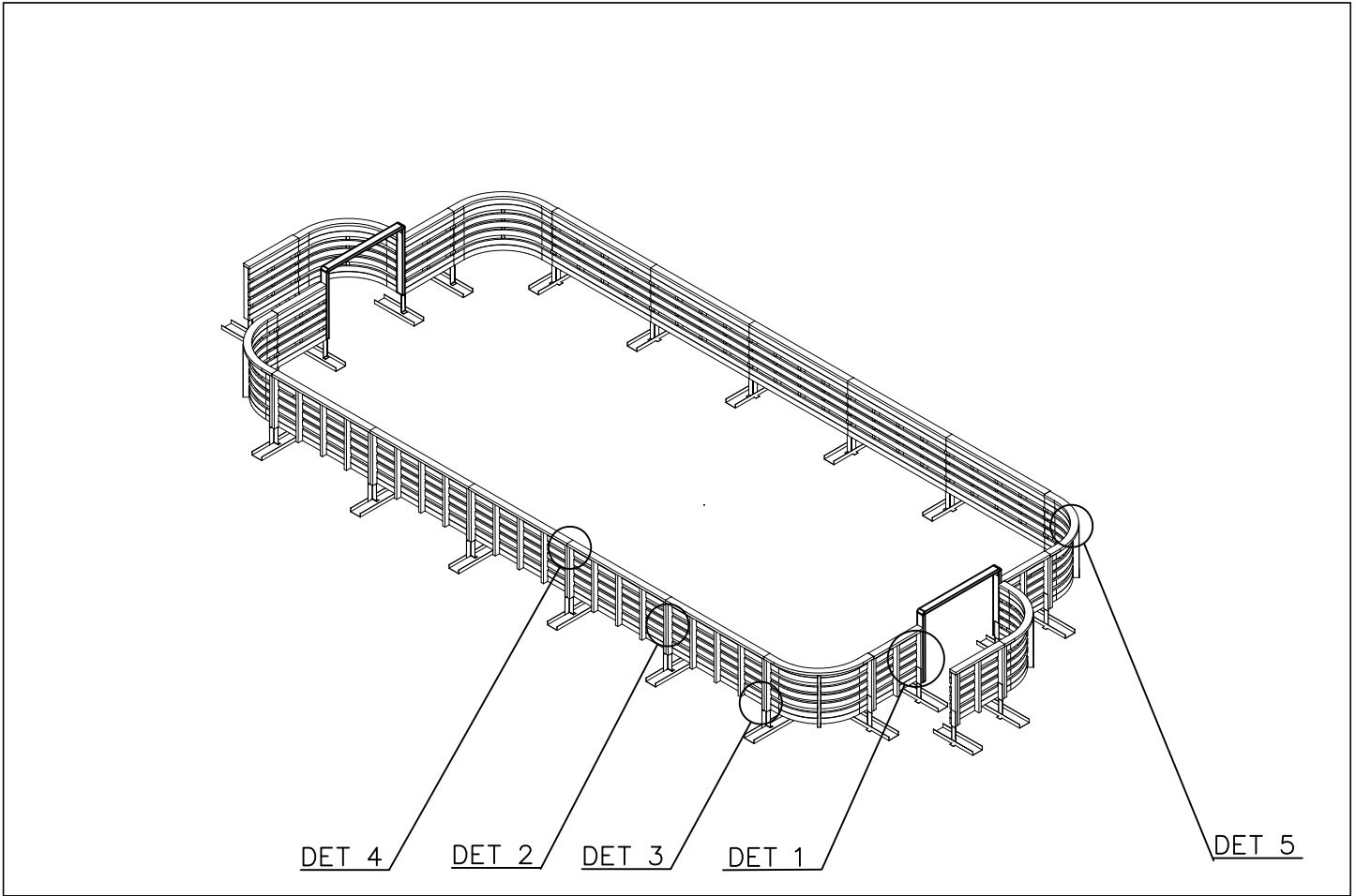

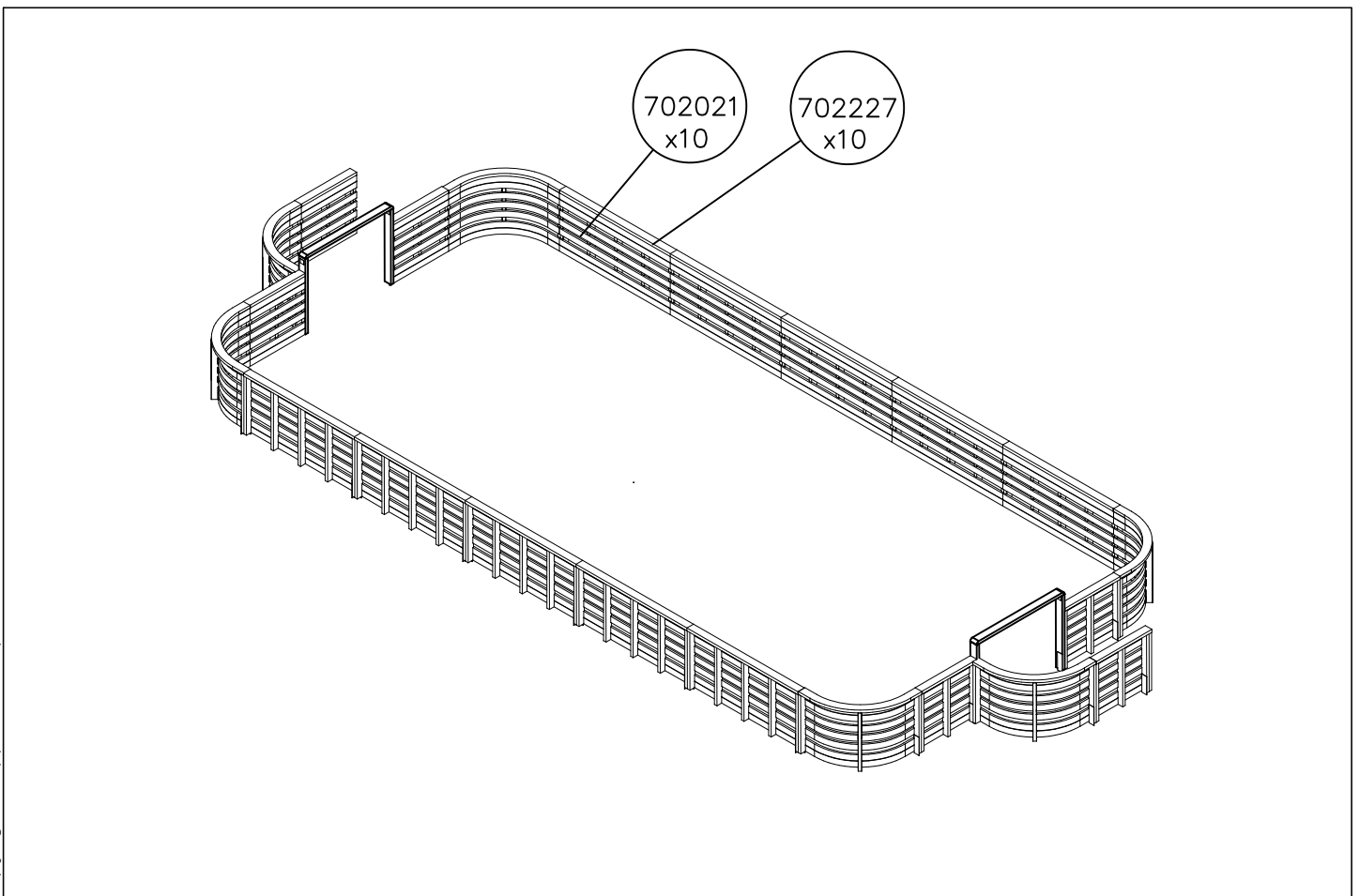
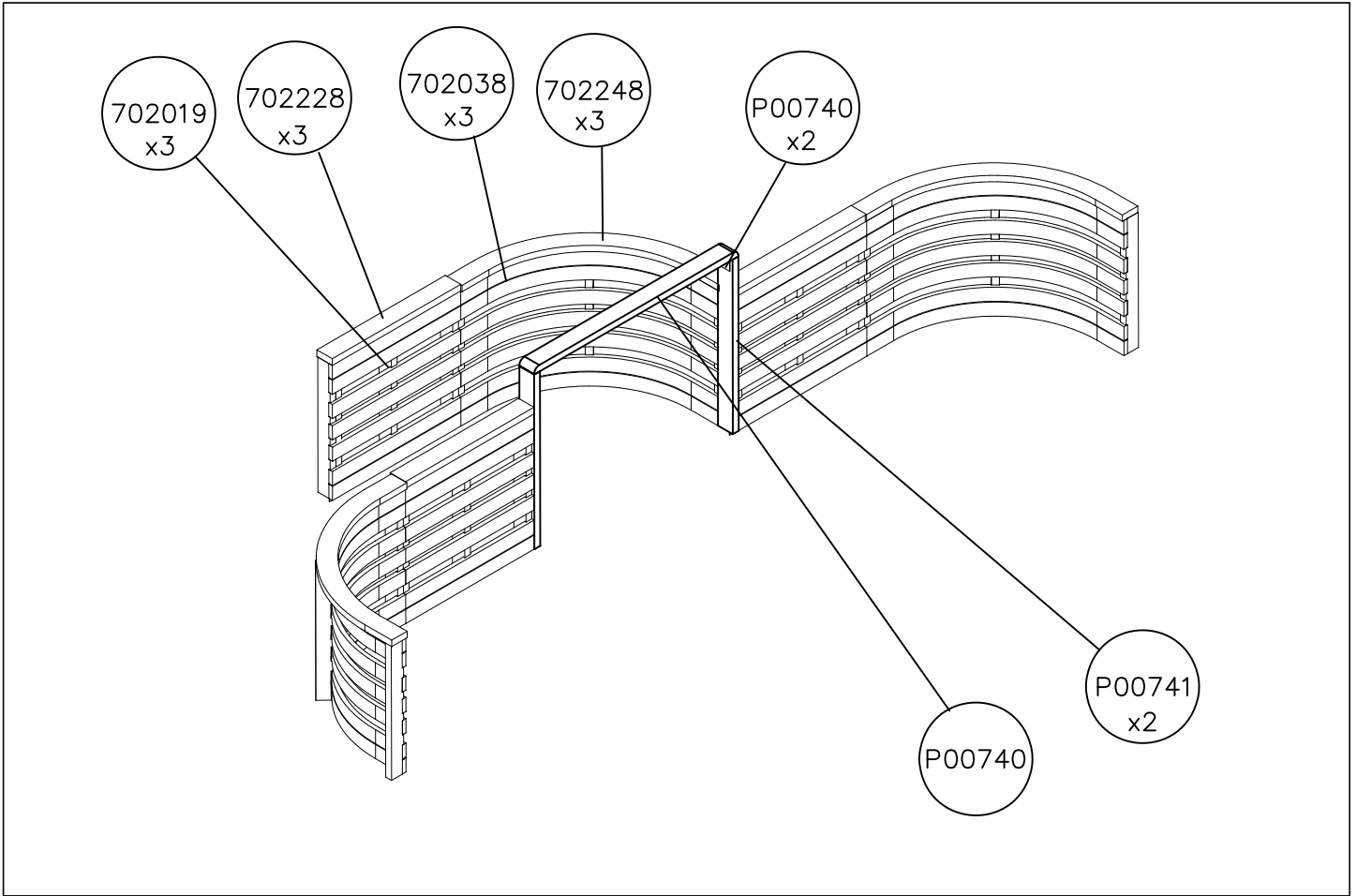



Tuotekyltti tulee tuotteen mukana yhdellä seuraavista tavoista:

1) Metallinen tuotekyltti ja kiinnitysruuvit

- Kiinnitä tuotekyltti ruuveilla tolppaan noin 2 metrin korkeuteen kuvan 1 mukaisesti.

2) Tuotekylttitarra

- Puhdista maalattu metalli- tai vaneripinta pölystä ja kosteudesta. Liimaa tarra kuvan 2 mukaisesti.
- Huom. Älä kiinnitä tarraa karheapintaiseen laminaattiin tai maalattuun puuhun.

Vår produktmärkning levereras på ett av följande sätt:

1) Produktskylt i metall

- Fäst skylten med de medföljande skruvarna

2) Självhäftande produktetikett

- Rengör den pulverlackerade metallytan eller laminatyten så att den blir fri från smuts och fukt. Fäst etiketten enligt fig. 2.
- Obs! Fäst ej etiketten på detaljer med skrovlig yta eller på målat trä.

Product label is delivered by one of following ways:

1) Metal product label and screws

- Fasten the label with screws.

2) Label sticker

- Clean the painted metal or plywood surface from dirt and moisture. Fasten the sticker as shown in the figure 2.
- Note. Do not attach the sticker to rough surfaced laminate or painted wood.

La plaque d'informations produit est livrée sous l'une de ces 3 formes :

1) Plaque métallique et vis

- Fixez la plaque à l'aide des vis.

2) Etiquette autocollante

- Avant de coller l'étiquette, nettoyez le composant métallique peint ou la plaque de contreplaqué, de toute saleté. La surface doit être sèche (voir image 2).
- Attention, ne pas coller l'étiquette sur une surface lamellé-collée irrégulière ou sur du bois peint.

Die Auslieferung des Produktaufklebers erfolgt auf eine dieser Arten:

1) Produkt-Schild aus Metall incl. Schrauben

- Die Befestigung des Schildes erfolgt mittels der Schrauben.

2) Aufkleber

- Entfernen Sie zunächst Schmutz und Feuchtigkeit vom lackierten Metall bzw. von der Holzoberfläche und bringen Sie den Aufkleber wie im Bild oben rechts beschrieben auf den gesäuberten Untergrund auf.
- Beachten Sie: Bringen Sie den Aufkleber nicht auf raues laminiertes oder lackiertes Holz an.

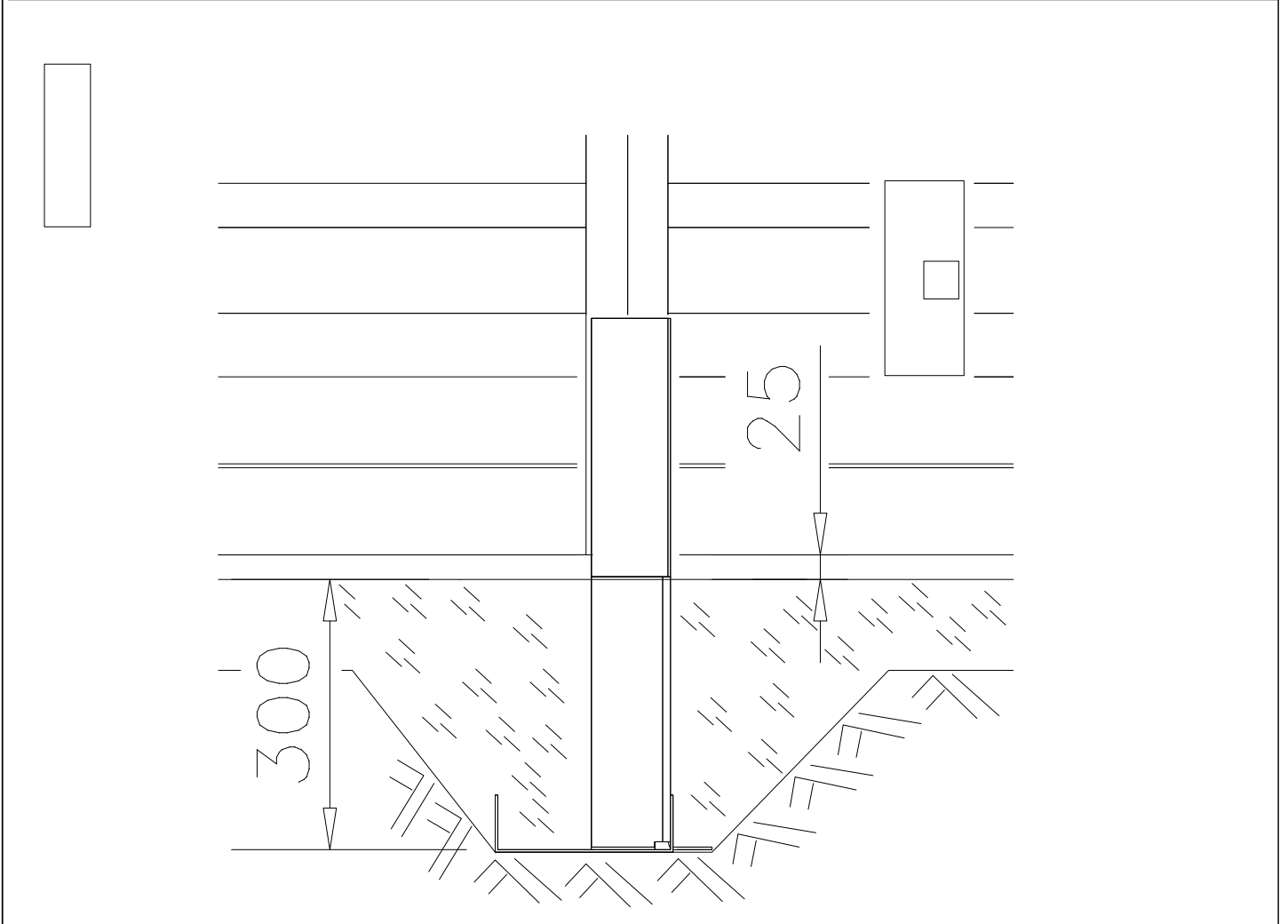
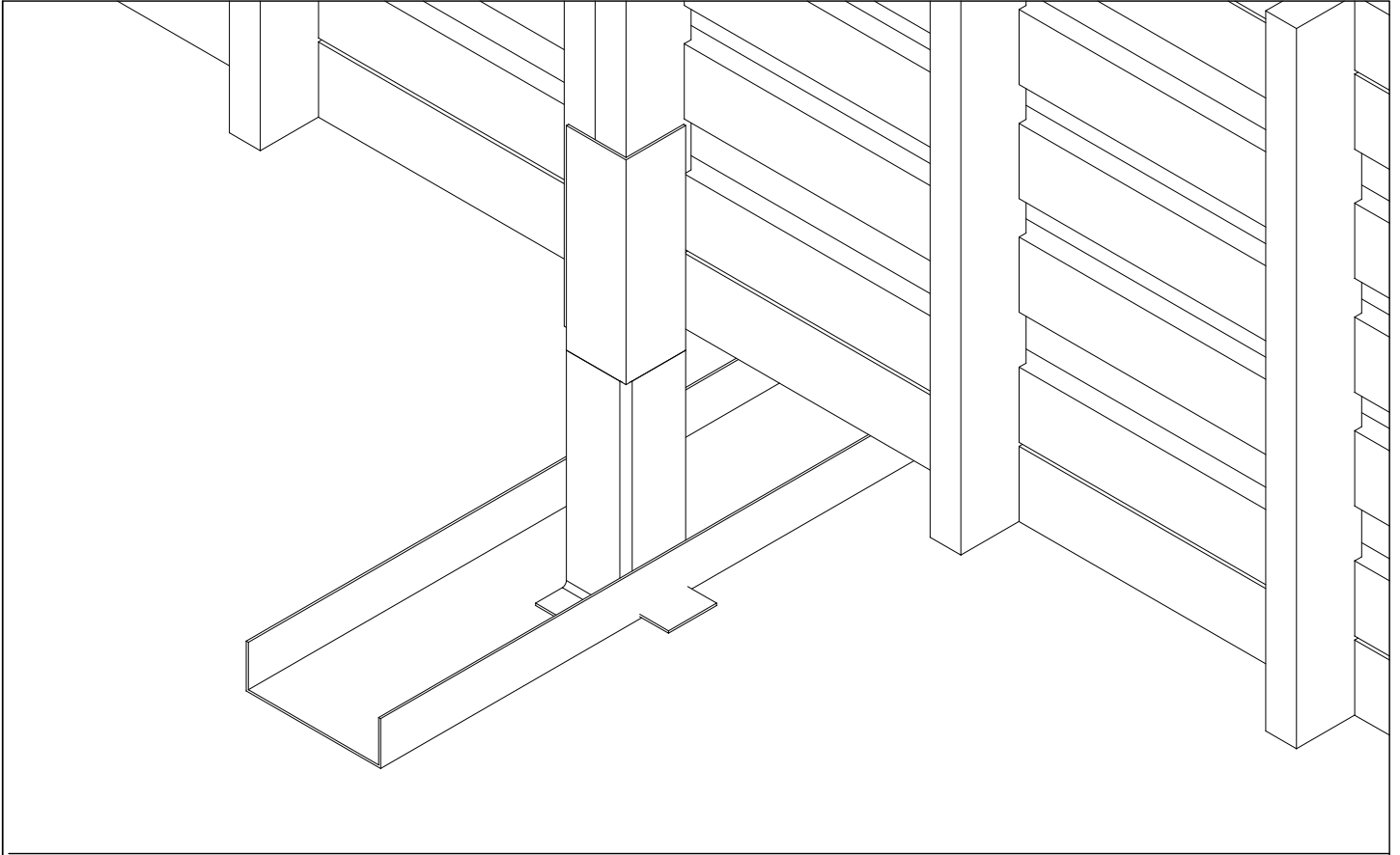

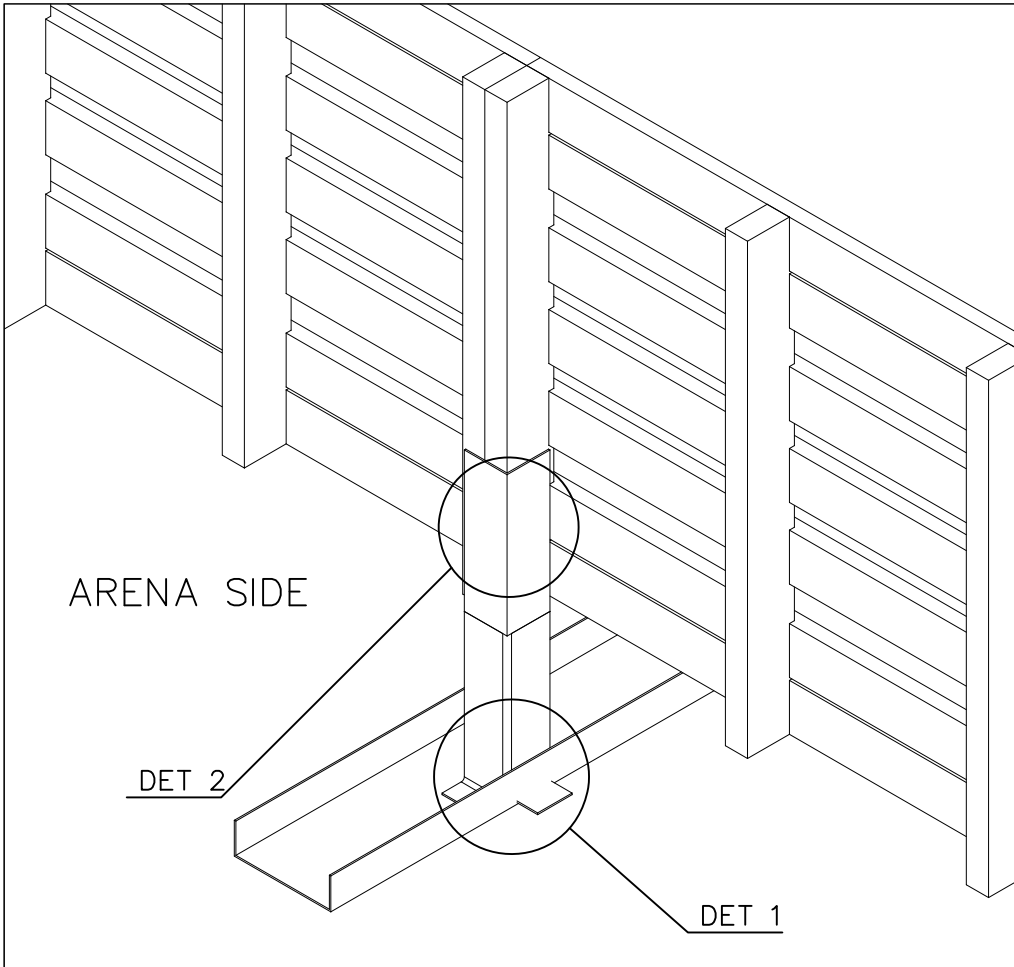

① 902433	PCS	② 902299	PCS
	1		1
③ 903149	PCS	④ 909248	PCS
	4		4
M12x30		M12	
⑤ 980154	PCS	⑥ 900240	PCS
	8		6
Ø24/13		Ø8x70	
	PCS		PCS

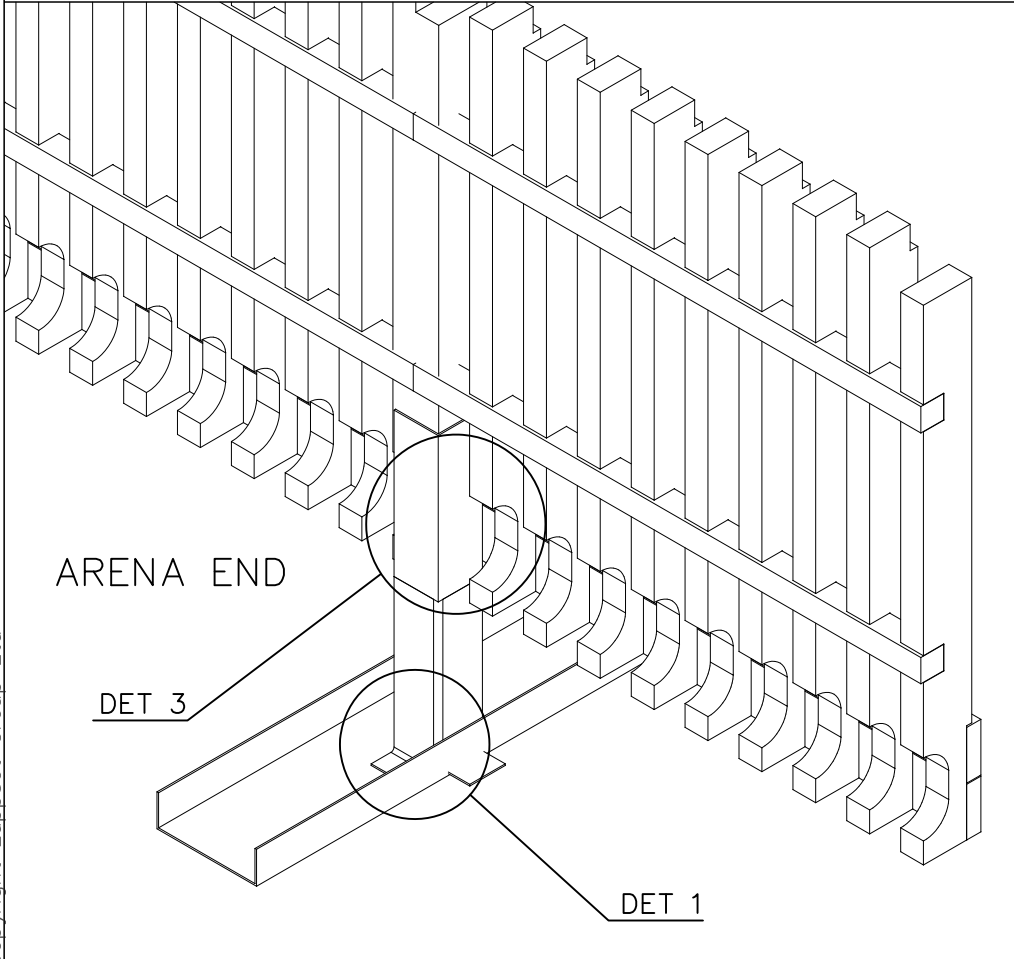

DET 1

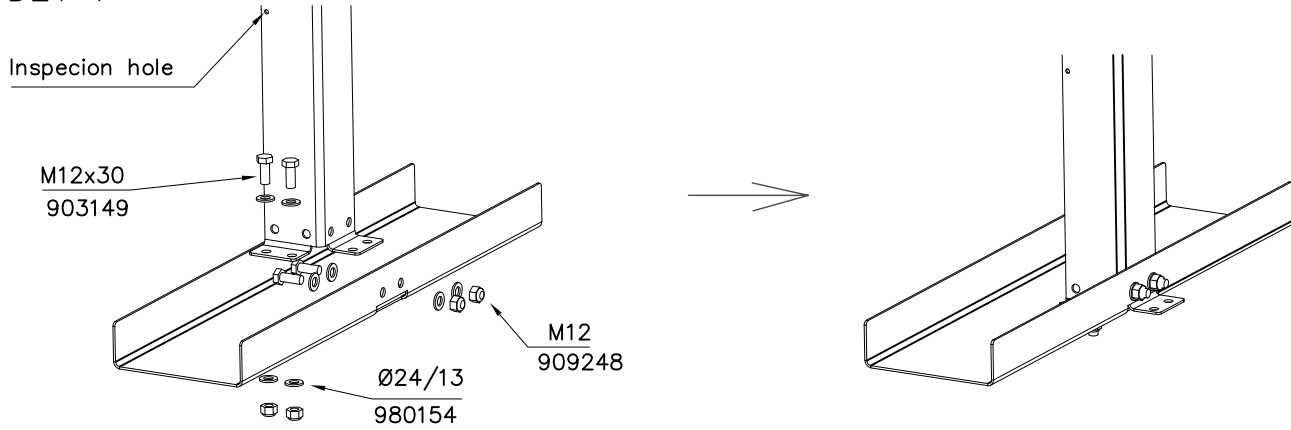

DET 2 ARENA SIDE

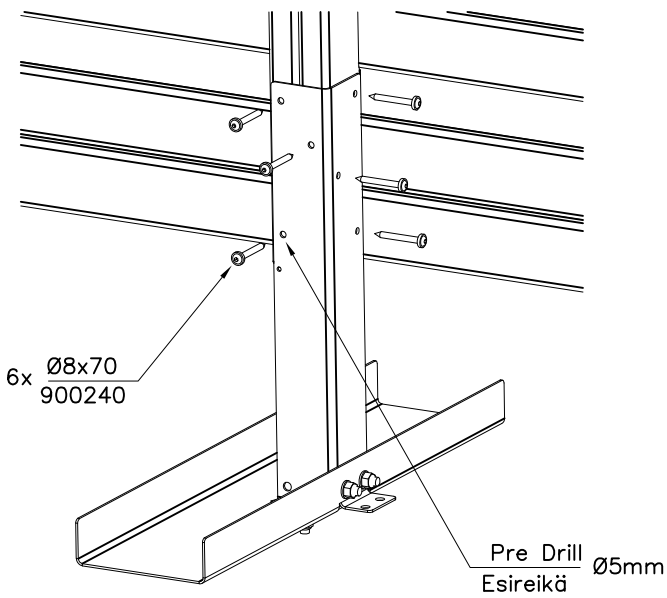

DET 3 ARENA END

