

LAPPSET®

CLOXX







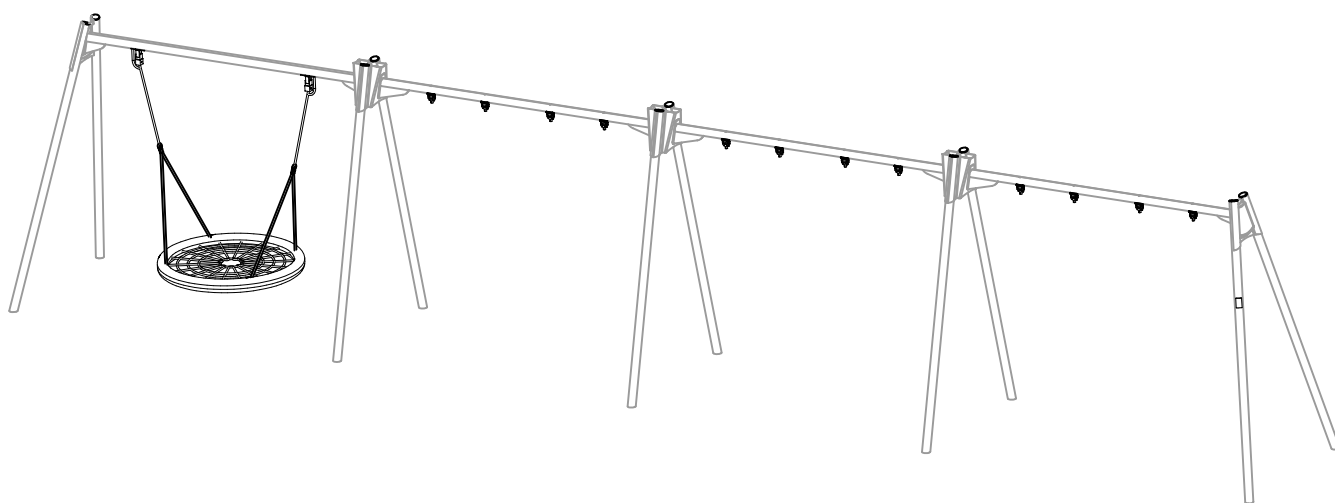

ASENNUSOHJE
MONTERINGSANSVISNING
INSTALLATION INSTRUCTION
AUFBAUANLEITUNG
NOTICE D'INSTALLATION

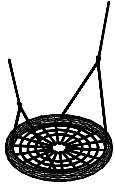
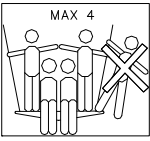
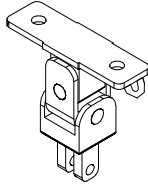
DATE: 17.6.2020

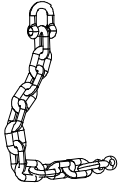
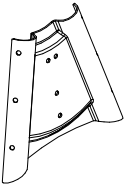
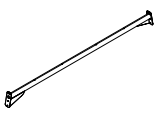
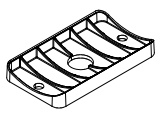
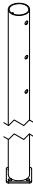
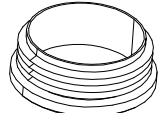
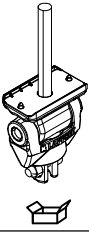
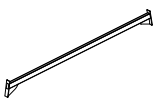
Q05272

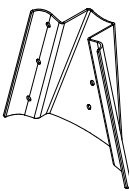
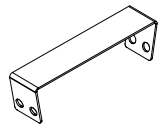

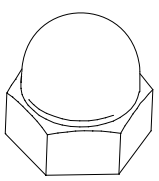
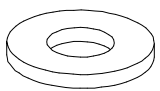
DATE: 29.5.2019

702341  90x50	PCS 1	703248 	PCS 1	708069  90x50	PCS 1	901958 	PCS 2	902234  M12	PCS 4	903577 	PCS 2
904422-205 	PCS 2	904428-205  L 2942	PCS 3	904430  72x41x9	PCS 12	904436-205  L 3367	PCS 4	904800  GL75x1-3,5	PCS 10	904904 	PCS 12
905636-205  L 2940	PCS 1	906499  M12x110	PCS 22	906617-205  L 3237	PCS 6	906620-205 	PCS 6	906621-205 	PCS 3	909141  M12x100	PCS 12
909347  M12x35	PCS 32	909644  M12	PCS 62	980154  Ø24/13	PCS 132	999561  GLUE 4101 ergo 10 g 10g	PCS 1		PCS		PCS
	PCS		PCS		PCS		PCS		PCS		PCS
	PCS		PCS		PCS		PCS		PCS		PCS
	PCS		PCS		PCS		PCS		PCS		PCS

EN/AS Impact Area 92.9 m²

Falling Space 92.9 m²

Max Falling Height 1400 mm

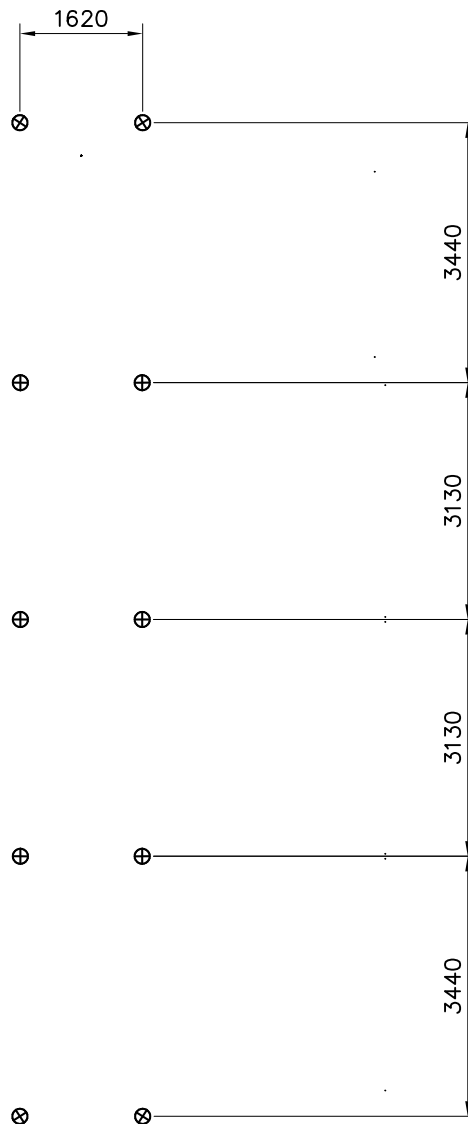

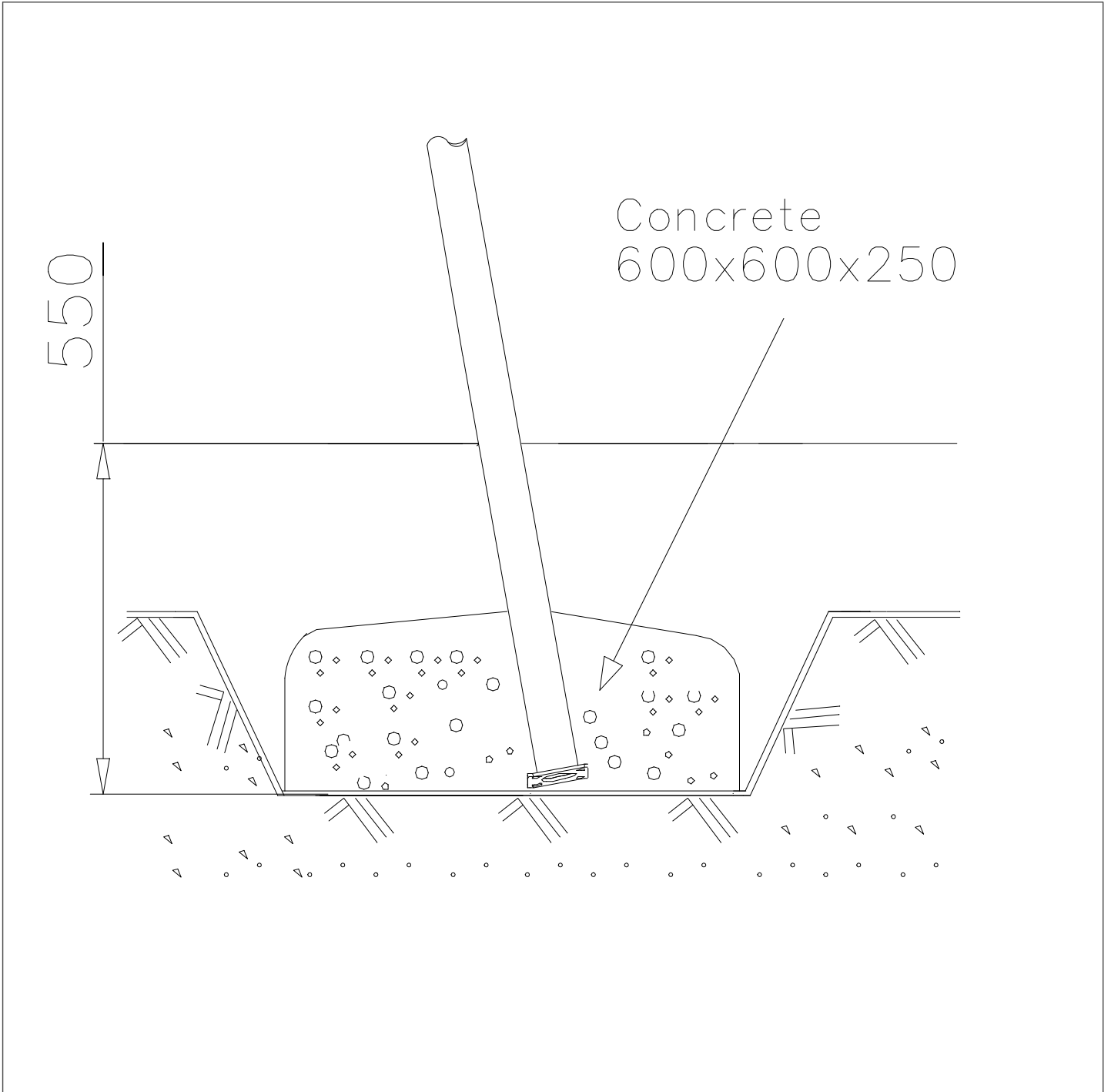

—— EN/AS Impact Area 92.9 m²

----- Falling Space 92.9 m²
Max Falling Height 1400 mm

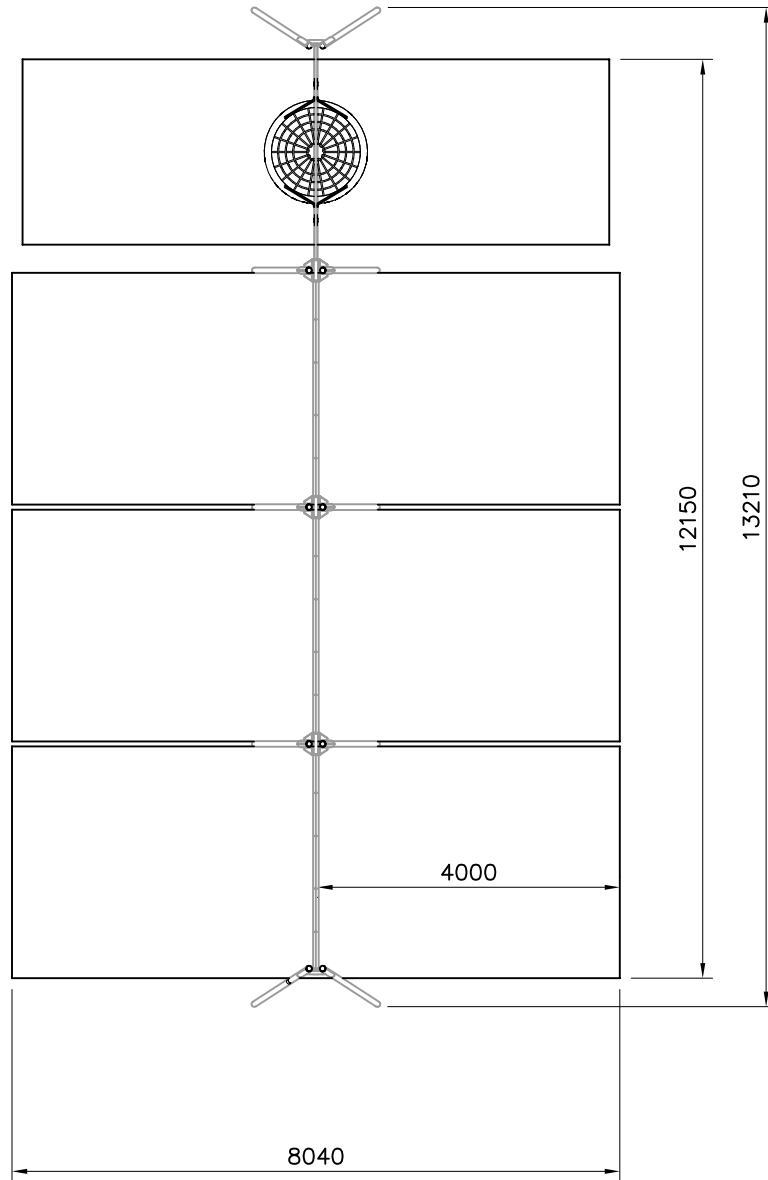
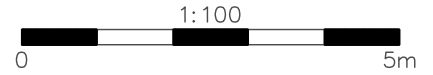

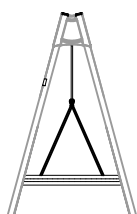

+2670

+2450



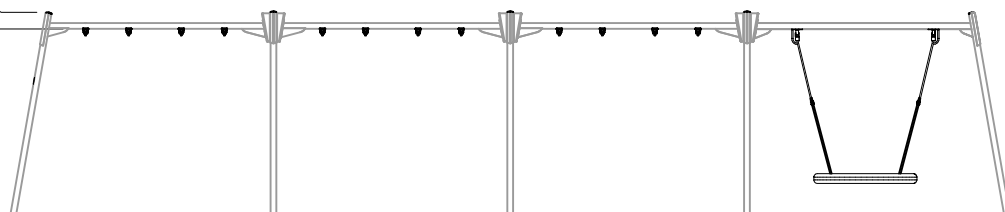

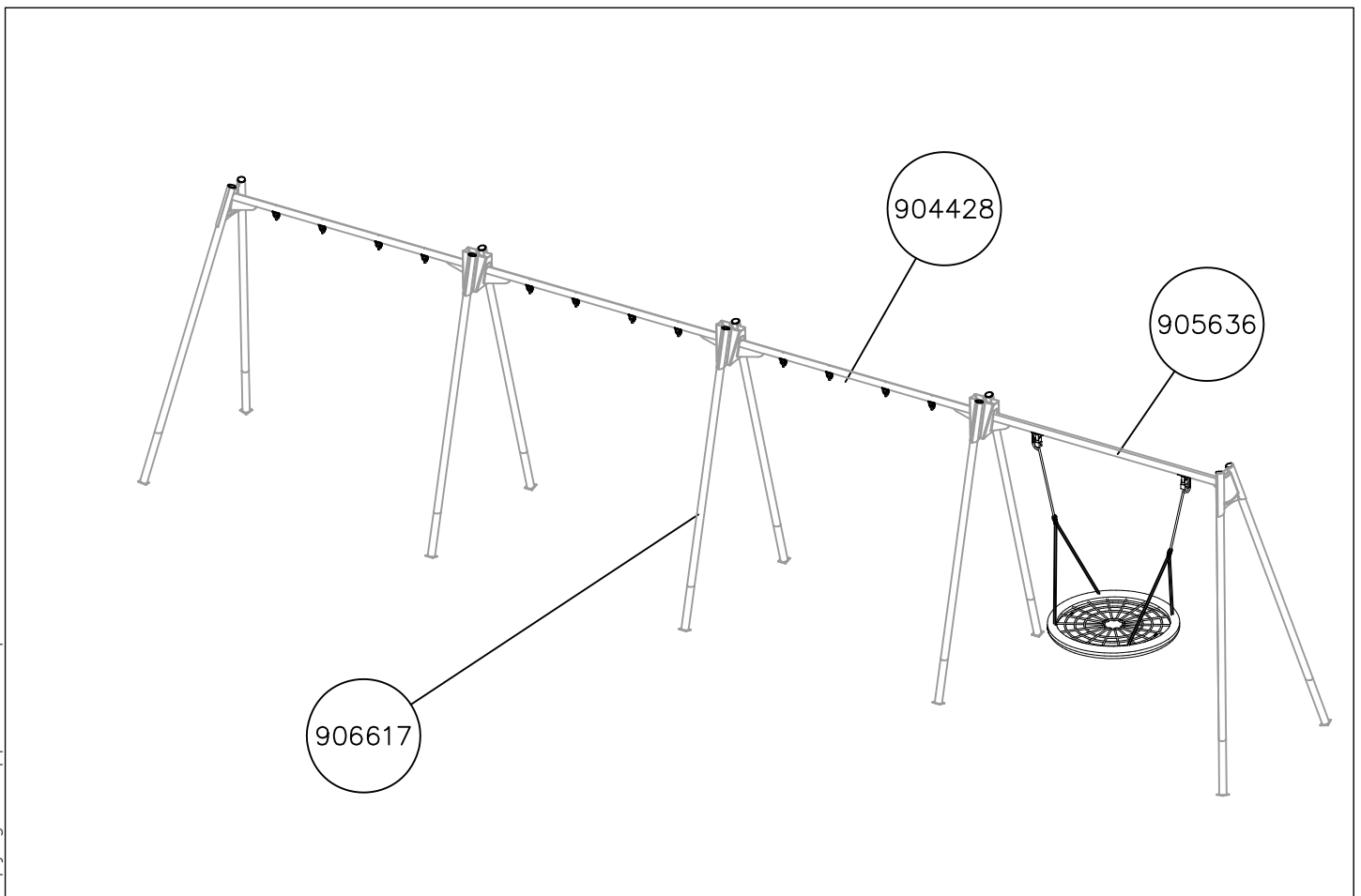
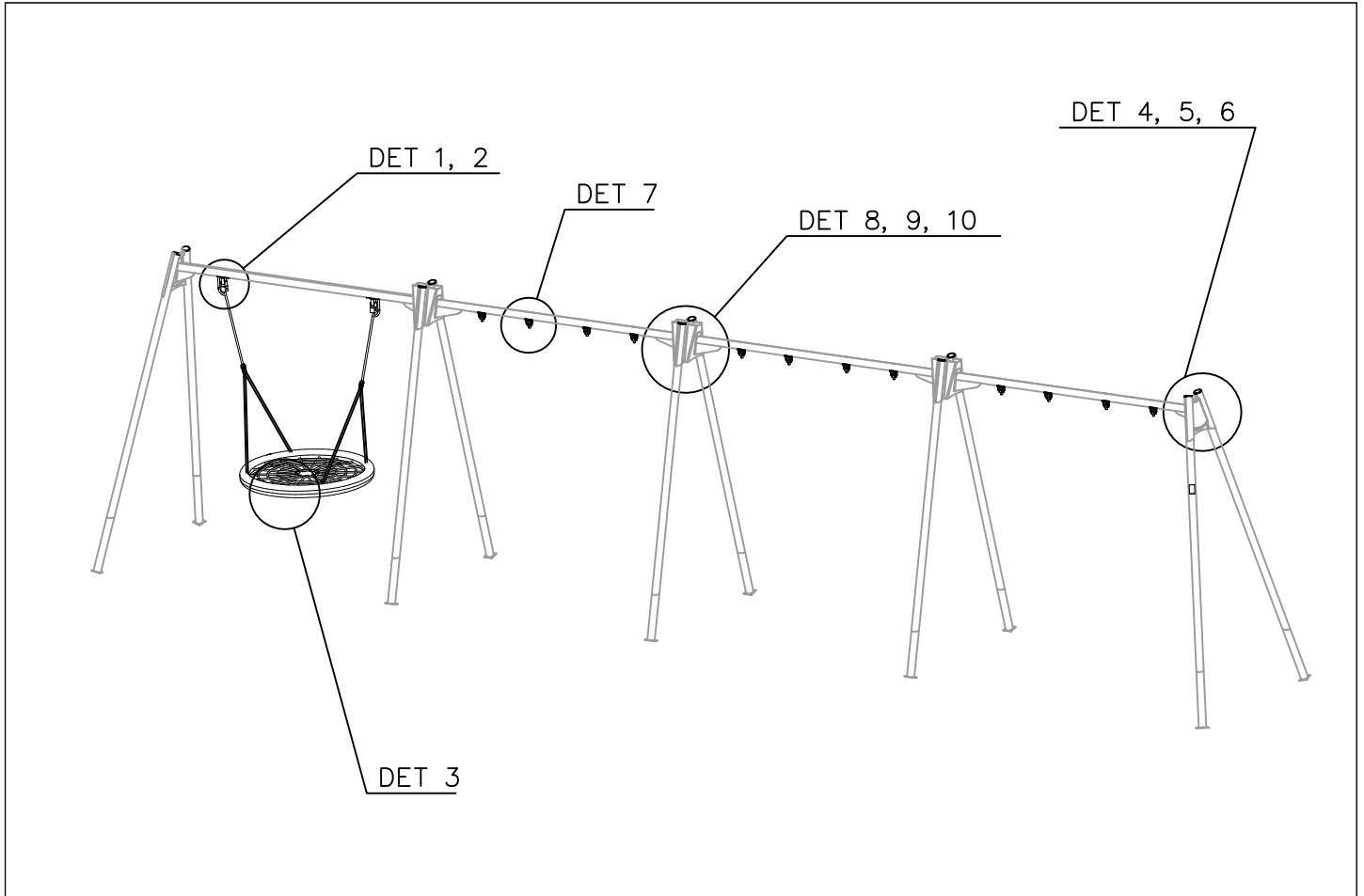
+0



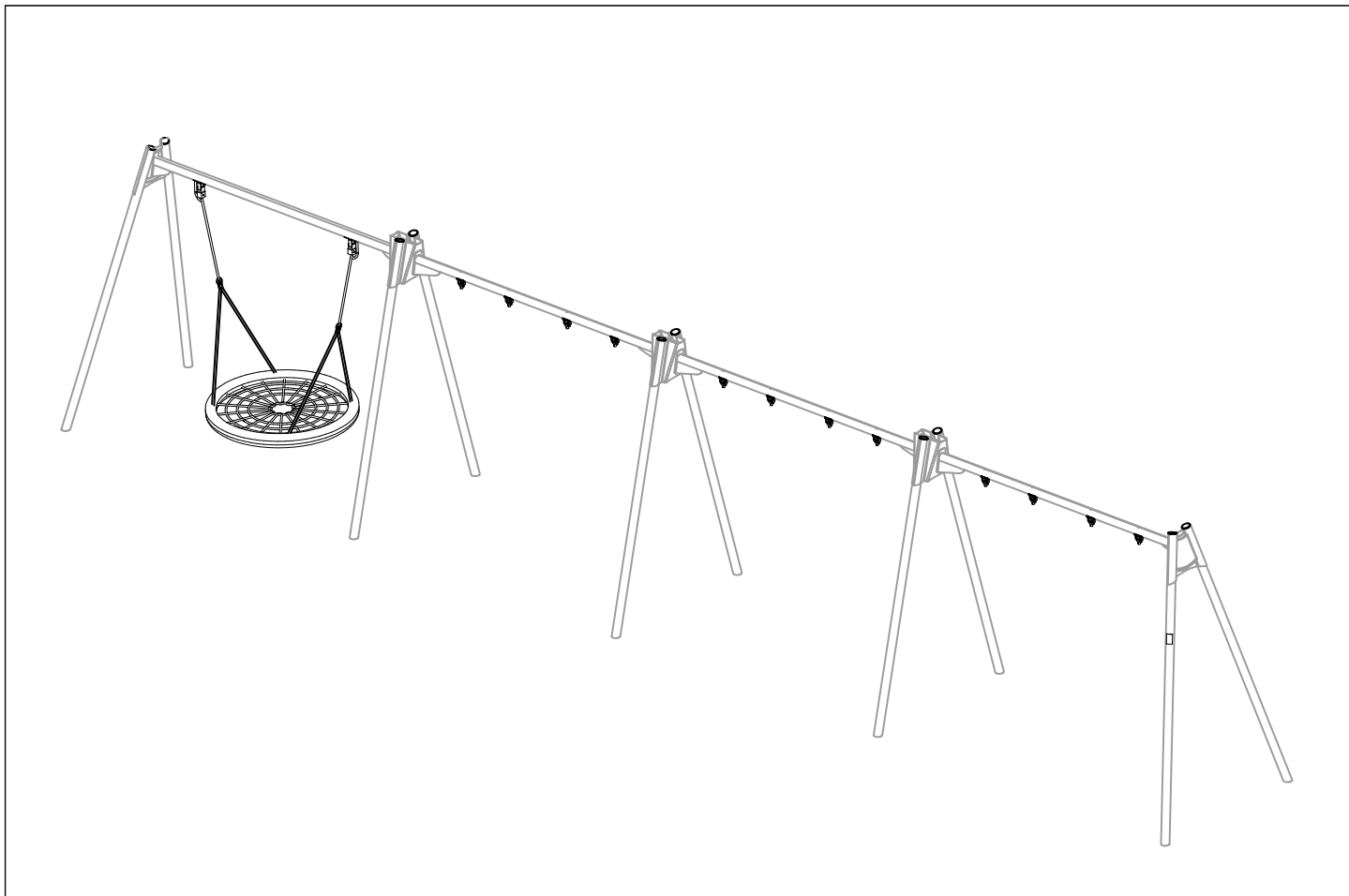

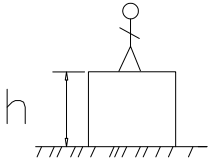
<p>DET 1</p>	<p>DET 2</p>	<p>DET 3</p>	<p>DET 4</p>
<p>DET 5</p>	<p>DET 6</p>	<p>DET 7</p>	<p>DET 8</p>
<p>DET 9</p>	<p>DET 10</p>		

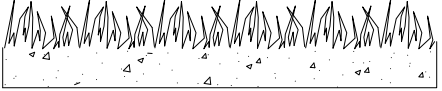
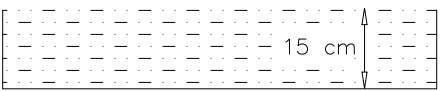
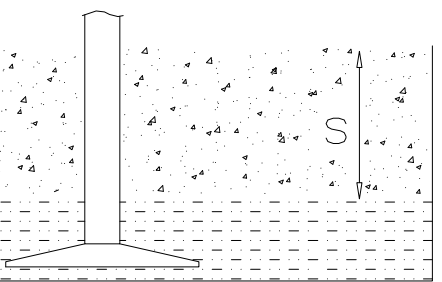
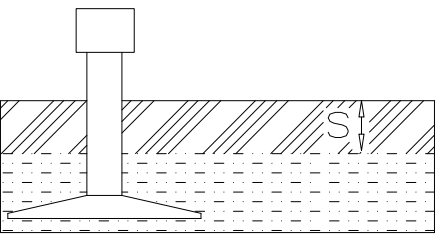

												
<p>$h < 600$</p> <p>Without movement and therefore without Impact Area</p>	<p>Totally hard surfaces.</p> <p>Note. Lappset does <u>not recommend</u> totally hard surfaces at all.</p>	<p>E.g. concrete or asphalt</p> 										
<p>$h < 600$</p> <p>With movement e.g. rocking</p>	<p>Materials with very limited impact attenuating properties.</p>	<p>E.g. wood</p> 										
<p>$h < 1000$</p>	<p>Materials with significant impact attenuating properties.</p>	<p>fine gravel 0–8 mm</p>  <p>grass</p>  <p>unsorted sand</p> 										
<p>$h < 3000$</p>	<p>Loose fill material</p> <p>E.g. sand/gravel 0,25...8 mm D60/D10<3,0 Woodchips 5...30 mm bark 20...80 mm</p>	 <table data-bbox="1024 1688 1327 1787"> <tr> <td>\underline{S}</td> <td>\underline{h}</td> </tr> <tr> <td>30 cm</td> <td>< 2,0 m</td> </tr> <tr> <td>40 cm</td> <td>< 3,0 m</td> </tr> </table>	\underline{S}	\underline{h}	30 cm	< 2,0 m	40 cm	< 3,0 m				
\underline{S}	\underline{h}											
30 cm	< 2,0 m											
40 cm	< 3,0 m											
	<p>Syntethic granulates</p> <table data-bbox="405 1899 753 2056"> <tr> <td>\underline{S}</td> <td>\underline{h}</td> </tr> <tr> <td>40 mm</td> <td>~> 1,2...1,3 m</td> </tr> <tr> <td>50 mm</td> <td>~> 1,5...1,7 m</td> </tr> <tr> <td>60 mm</td> <td>~> 1,8...2,0 m</td> </tr> <tr> <td>70 mm</td> <td>~> 2,1...2,5 m</td> </tr> </table> <p>Note. For accurate values, see manufacturer's instructions.</p>	\underline{S}	\underline{h}	40 mm	~> 1,2...1,3 m	50 mm	~> 1,5...1,7 m	60 mm	~> 1,8...2,0 m	70 mm	~> 2,1...2,5 m	
\underline{S}	\underline{h}											
40 mm	~> 1,2...1,3 m											
50 mm	~> 1,5...1,7 m											
60 mm	~> 1,8...2,0 m											
70 mm	~> 2,1...2,5 m											

REMOVE SAFETY SURFACE/SAND/GRAVEL
TO CHECK FOUNDATION

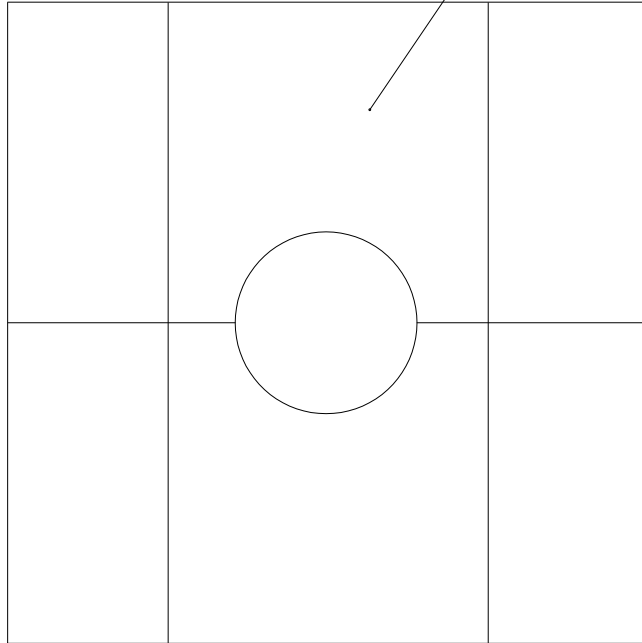

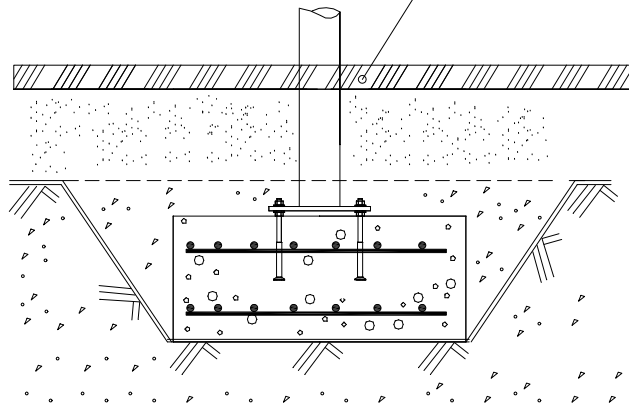

REMOVE SAFETY SURFACE/SAND/GRAVEL
TO CHECK FOUNDATION



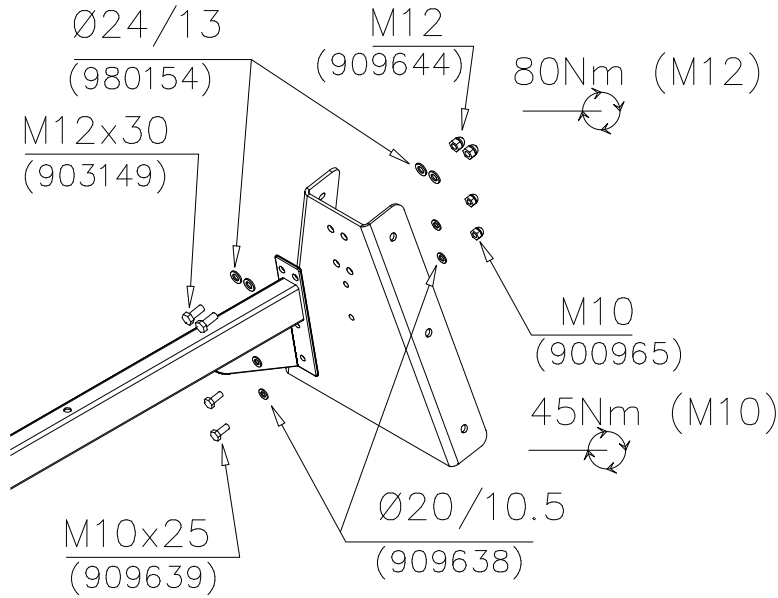

DET A

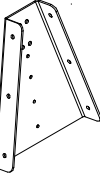

-  M12x30 2 pcs
-  Ø24/13 4 pcs
-  M12 2 pcs
-  M10x25 2 pcs
-  Ø20/10.5 4 pcs
-  M10 2 pcs
-  905991 1 pcs

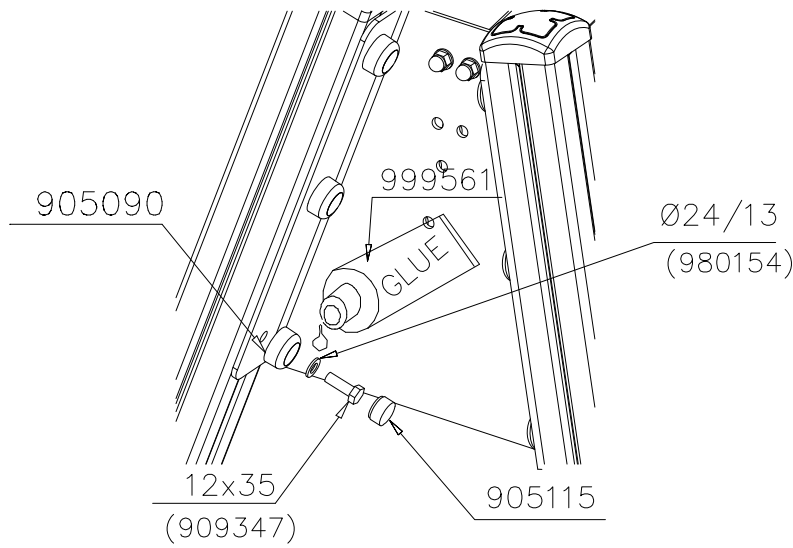
DET A1



-  M12x35 6 pcs
-  Ø24/13 6 pcs
-  Ø45 6 pcs
-  Ø30 6 pcs
-  GLUE

DET B

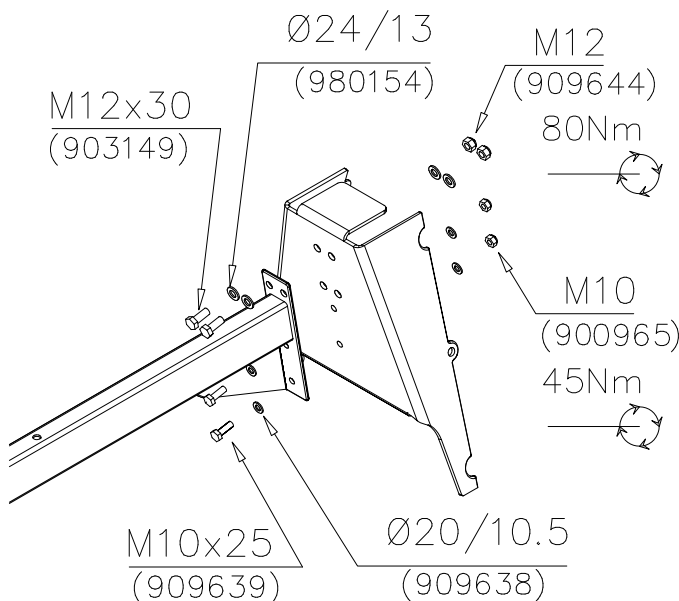

-  M12x30 2 pcs
-  Ø24/13 4 pcs
-  M12 2 pcs
-  M10x25 2 pcs
-  Ø20/10.5 4 pcs
-  M10 2 pcs

DET B

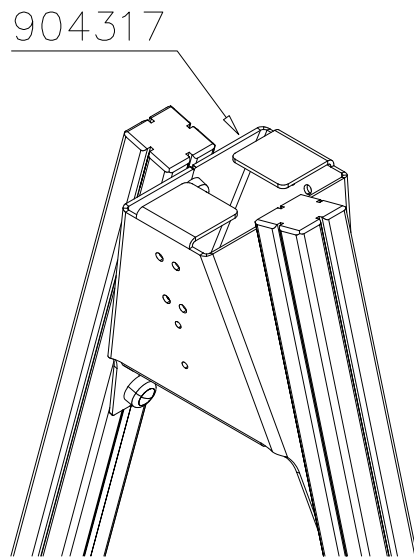

904317

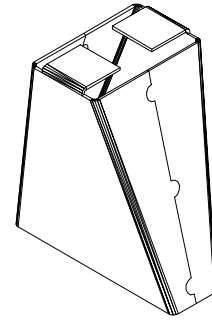

904317

DET B1

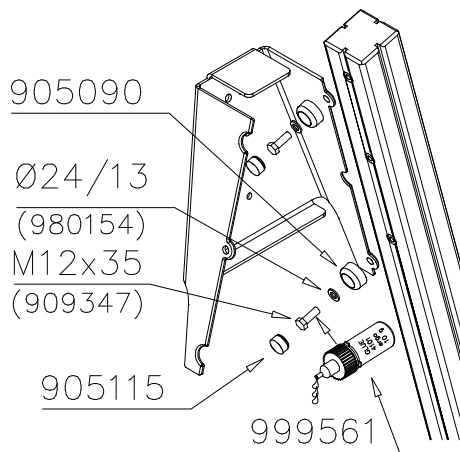

905090

Ø24/13

(980154)

M12x35

(909347)

905115

999561



M12x35 6 pcs



Ø24/13 6 pcs

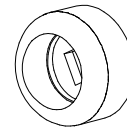

Ø45 6 pcs

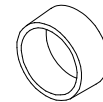

Ø30 6 pcs



GLUE

DET C

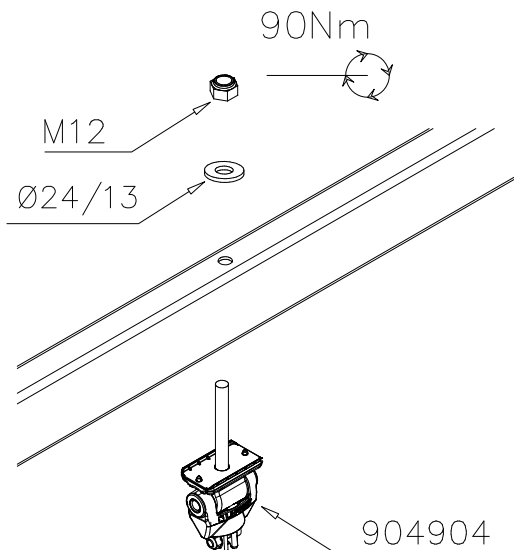

90Nm

M12

Ø24/13

904904

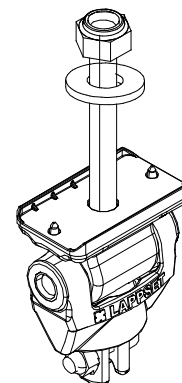

904904

DET D

90Nm

M12x110
(906499)

Ø24/13
(980154)

901958

M8x35

Ø24/13
(980154)

M12
(902234)

M8

CUT EXTRA CHAIN

M12x110 2 pcs

Ø24/13 4 pcs

M12 2 pcs

901958 1 pcs

DET D

903577

903577 1 pcs

DET E

6x60
980131

980131 4 pcs

905138 1 pcs

905196 1 pcs

REF: SWING
DATE: 29.6.2022

DET F

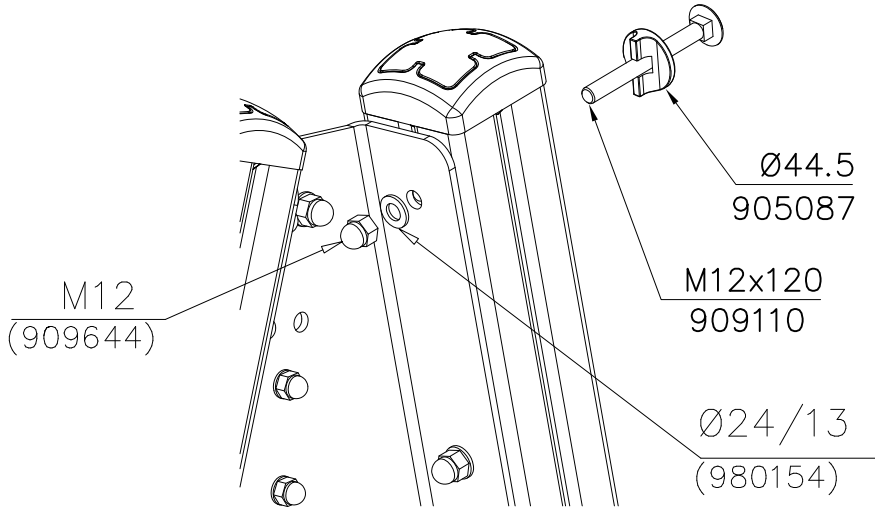

DET G

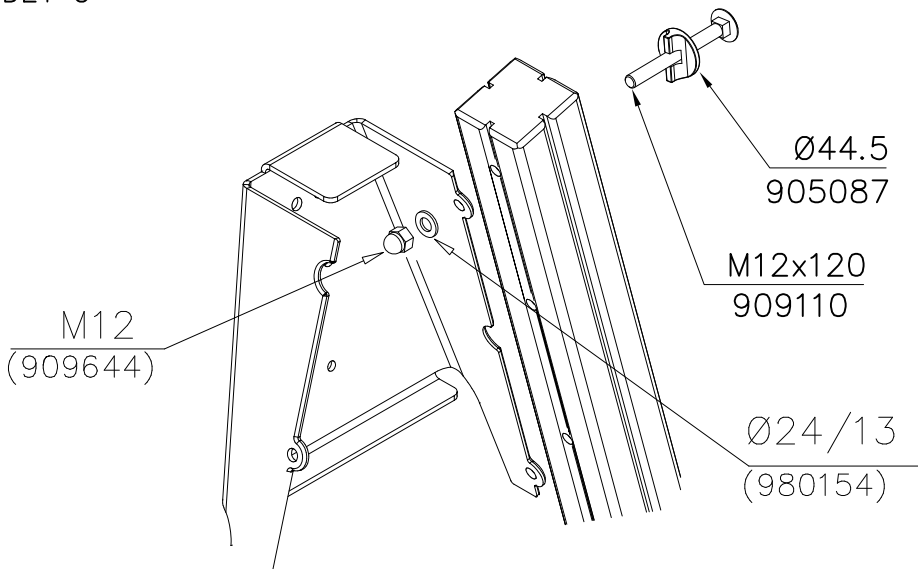

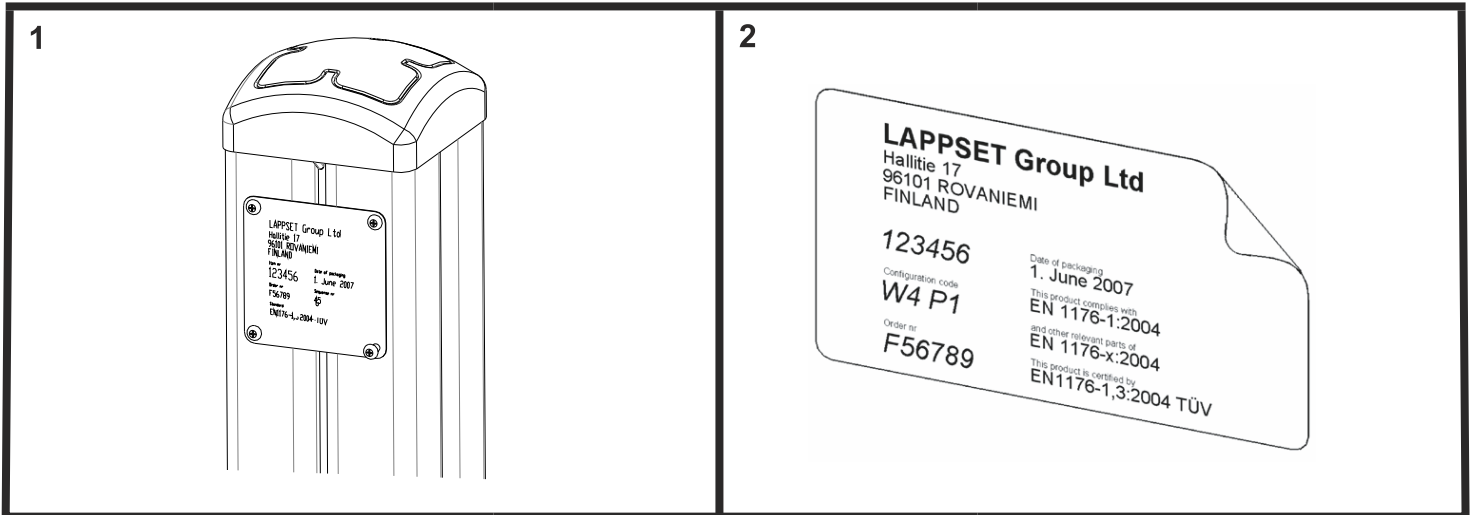
**Tuotekyltti tulee tuotteen mukana yhdellä seuraavista tavoista:****1) Metallinen tuotekyltti ja kiinnitysruuvit**

- Kiinnitä tuotekyltti ruuveilla tolppaan noin 2 metrin korkeuteen kuvan 1 mukaisesti.

2) Tuotekylttitarra

- Puhdista maalattu metalli- tai vaneripinta pölystä ja kosteudesta. Liimaa tarra kuvan 2 mukaisesti.
- Huom. Älä kiinnitä tarraa karheapintaiseen laminaattiin tai maalattuun puuhun.

Vår produktmärkning levereras på ett av följande sätt:**1) Produktskylt i metall**

- Fäst skylten med de medföljande skruvarna

2) Självhäftande produktetikett

- Rengör den pulverlackerade metallytan eller laminatyten så att den blir fri från smuts och fukt. Fäst etiketten enligt fig. 2.
- Obs! Fäst ej etiketten på detaljer med skrovlig yta eller på målat trä.

Product label is delivered by one of following ways:**1) Metal product label and screws**

- Fasten the label with screws.

2) Label sticker

- Clean the painted metal or plywood surface from dirt and moisture. Fasten the sticker as shown in the figure 2.
- Note. Do not attach the sticker to rough surfaced laminate or painted wood.

La plaque d'informations produit est livrée sous l'une de ces 3 formes :**1) Plaque métallique et vis**

- Fixez la plaque à l'aide des vis.

2) Etiquette autocollante

- Avant de coller l'étiquette, nettoyez le composant métallique peint ou la plaque de contreplaqué, de toute saleté. La surface doit être sèche (voir image 2).
- Attention, ne pas coller l'étiquette sur une surface lamellé-collée irrégulière ou sur du bois peint.

Die Auslieferung des Produktaufklebers erfolgt auf eine dieser Arten:**1) Produkt-Schild aus Metall incl. Schrauben**

- Die Befestigung des Schildes erfolgt mittels der Schrauben.

2) Aufkleber

- Entfernen Sie zunächst Schmutz und Feuchtigkeit vom lackierten Metall bzw. von der Holzoberfläche und bringen Sie den Aufkleber wie im Bild oben rechts beschrieben auf den gesäuberten Untergrund auf.
- Beachten Sie: Bringen Sie den Aufkleber nicht auf raues laminiertes oder lackiertes Holz an.

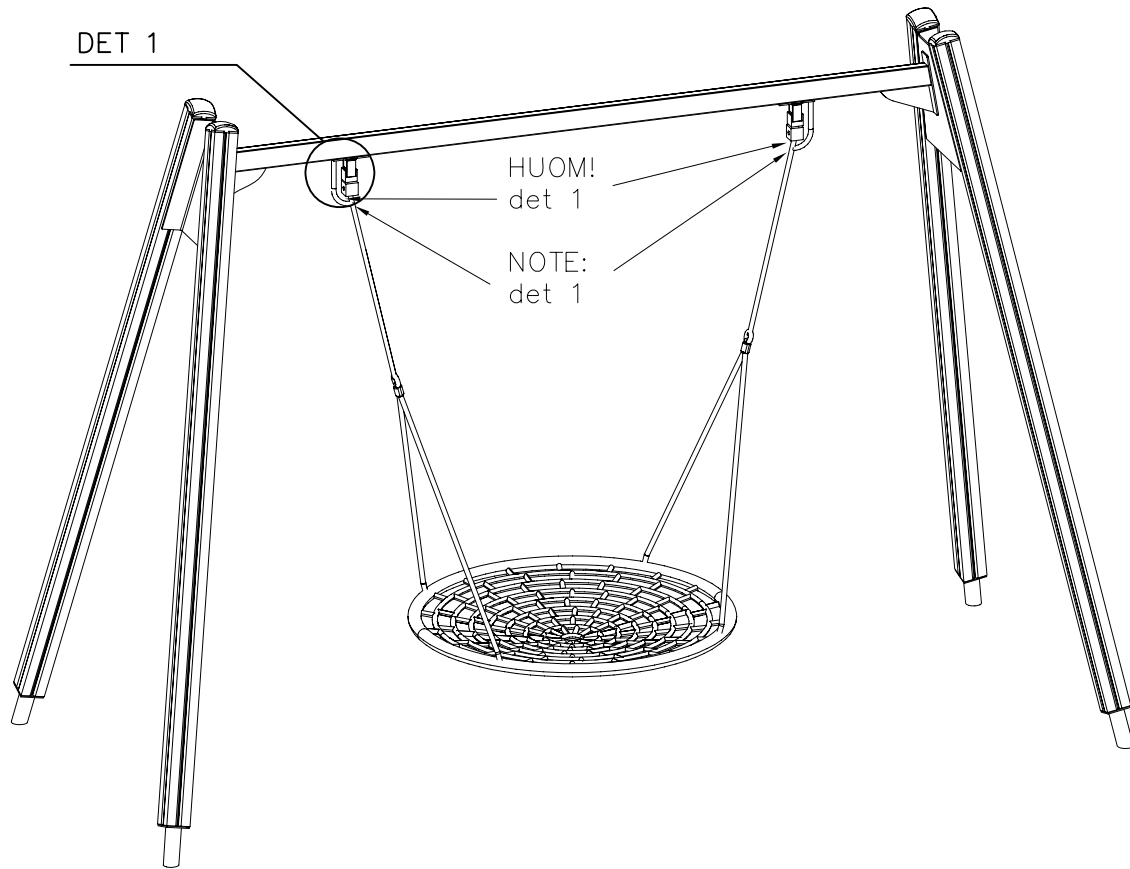

DET 1

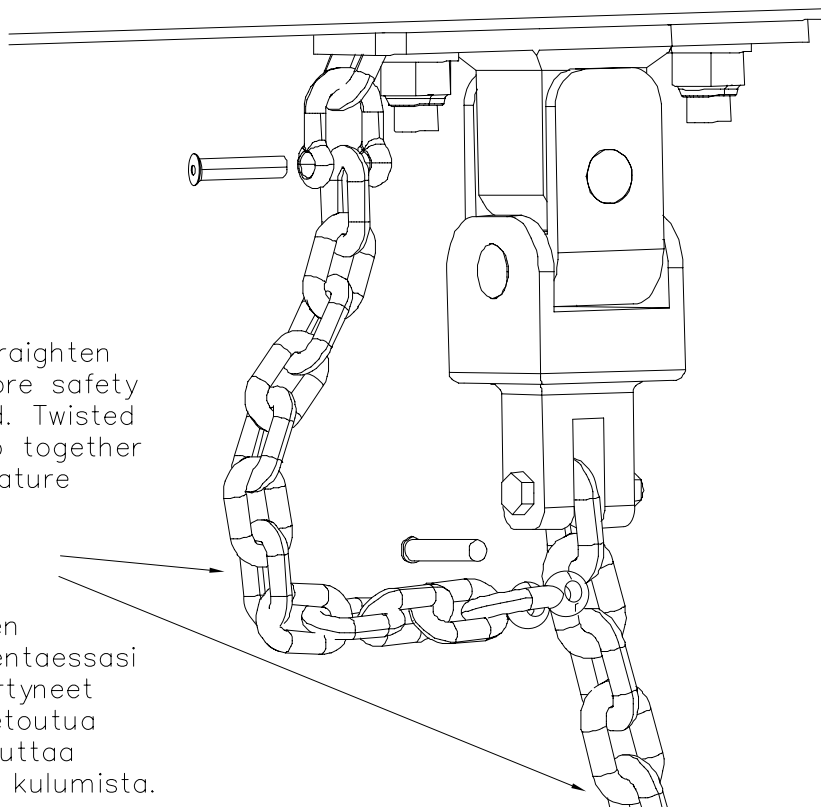

Note:
Make sure to straighten both chains before safety chain is installed. Twisted chains may wrap together and cause premature wear.

Huom!
Varmistu ketjujen suoruudesta asentaessasi turvaketjua. Kiertyneet ketjut voivat kietoutua toisiinsa ja aiheuttaa ketjujen nopeaa kulumista.