

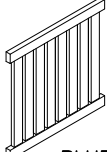

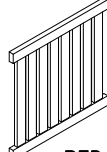

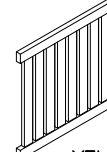

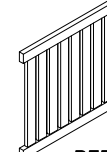

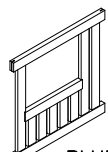
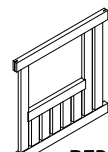
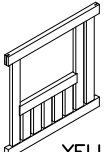
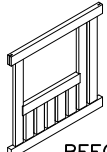
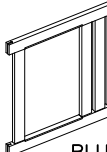
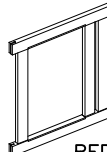
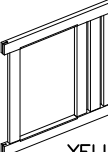
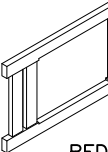
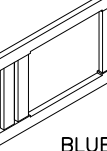
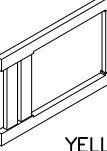
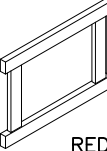
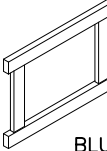
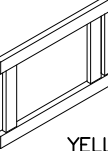
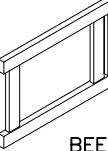
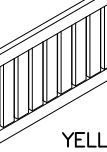
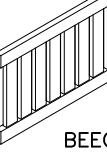
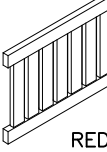
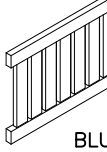
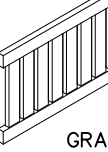
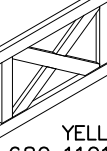

M 120	 BLUE 1065x1101	PCS 1	 RED 1065x1101	PCS 1	 YELL 1065x1101	PCS 1	 BEECH 1065x1101	PCS 1	 BLUE 1065x1101	PCS 1	 RED 1065x1101	PCS 1
	 YELL 1065x1101	PCS 1	 BEECH 1065x1101	PCS 1	 BLUE 1065x1101	PCS 1	 RED 1065x1101	PCS 1	 YELL 1065x1101	PCS 1	 RED 680x1101	PCS 1
	 BLUE 680x1101	PCS 1	 YELL 680x1101	PCS 1	 RED 680x1101	PCS 1	 BLUE 680x1101	PCS 1	 YELL 680x1101	PCS 1	 BEECH 680x1101	PCS 1
	 YELL 680x1101	PCS 1	 BEECH 680x1101	PCS 1	 RED 680x1101	PCS 1	 BLUE 680x1101	PCS 1	 GRAY 680x1101	PCS 1		PCS
	 YELL 680x1101	PCS 1	 GRAY 680x1101	PCS 1		PCS		PCS	 003701 (003651) 701794 (701307) 701795 (701308) 008001 (003666)		 003786 (003657) 003787 (003658) 003779 (701616) 003788 (003659) 007999 (003664)	
	 BLUE 680x701	PCS 1	 YELL 680x701	PCS 1	 BEECH 680x701	PCS 1	 RED 680x701	PCS 1	003700 (003650) 701618 (701309) 701619 (701310) 008000 (003665)		003702 (003652) 701796 (701305) 701797 (701306)	
	PCS		PCS		PCS		PCS	003785 (003656) 701798 (701314) 701799 (701315)		702293 (702292) 701591 (701234) 701590 (701235) 701589 (701270)		
	PCS	 ① 909530	PCS 4	 ② 909217	PCS 4	 ③ 980151	PCS 4	 ④ 905112	PCS 4	 ⑤ 905120	PCS 4	
				8x70		Ø16/8.4		Ø22		Ø14		

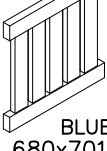
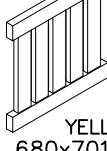
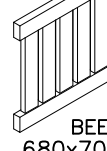
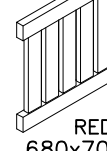
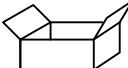
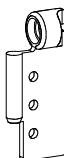
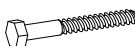

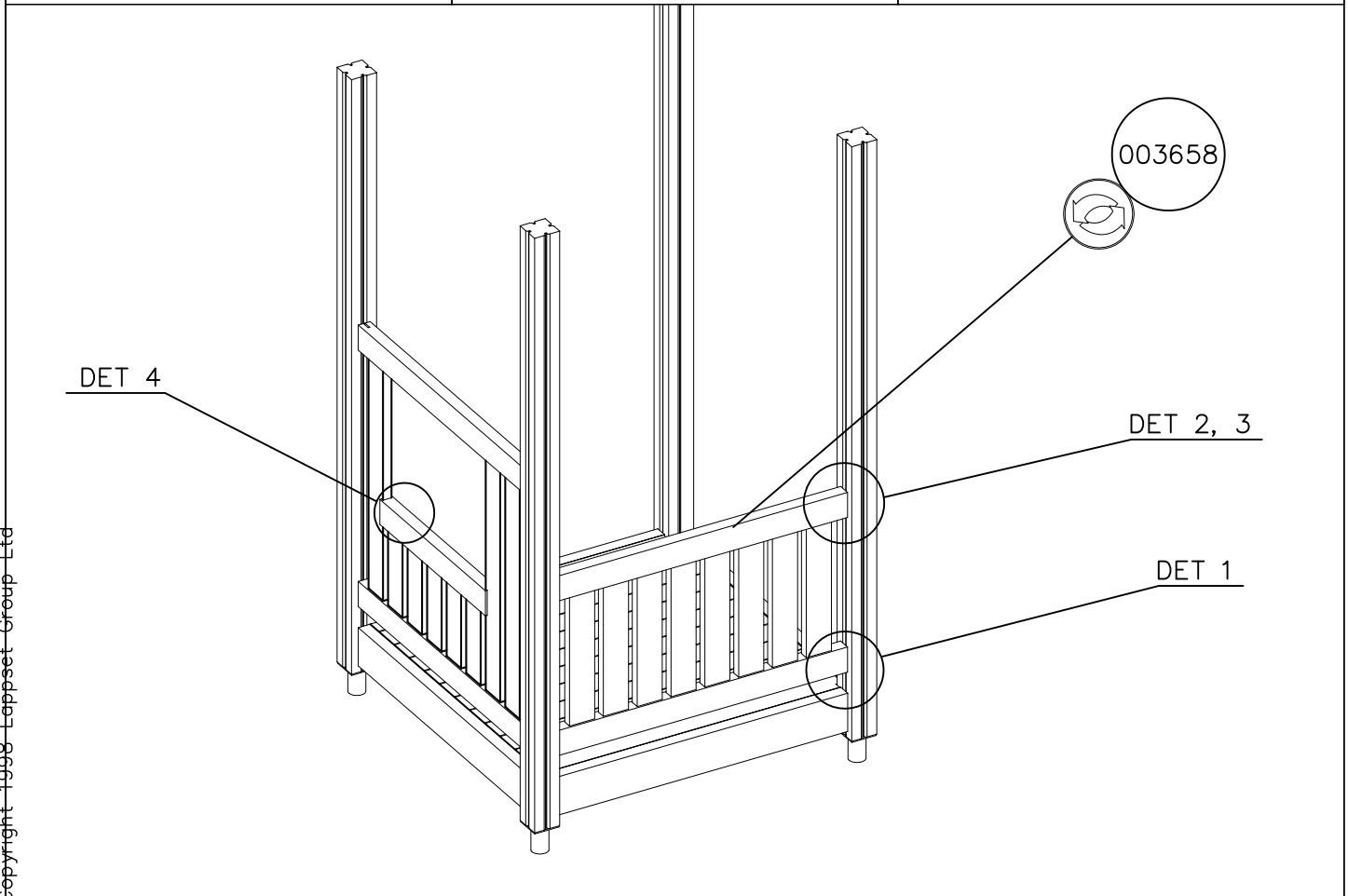
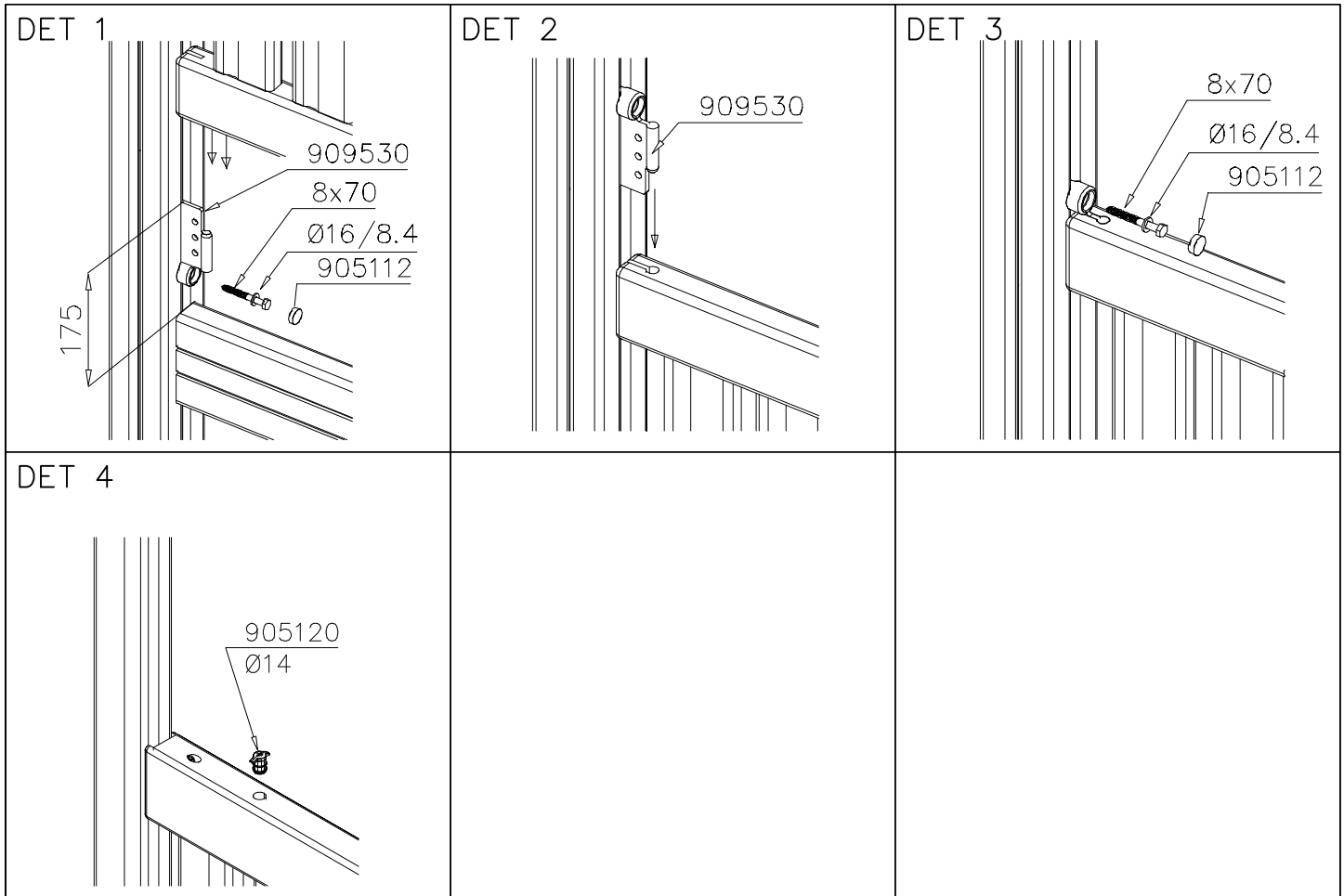
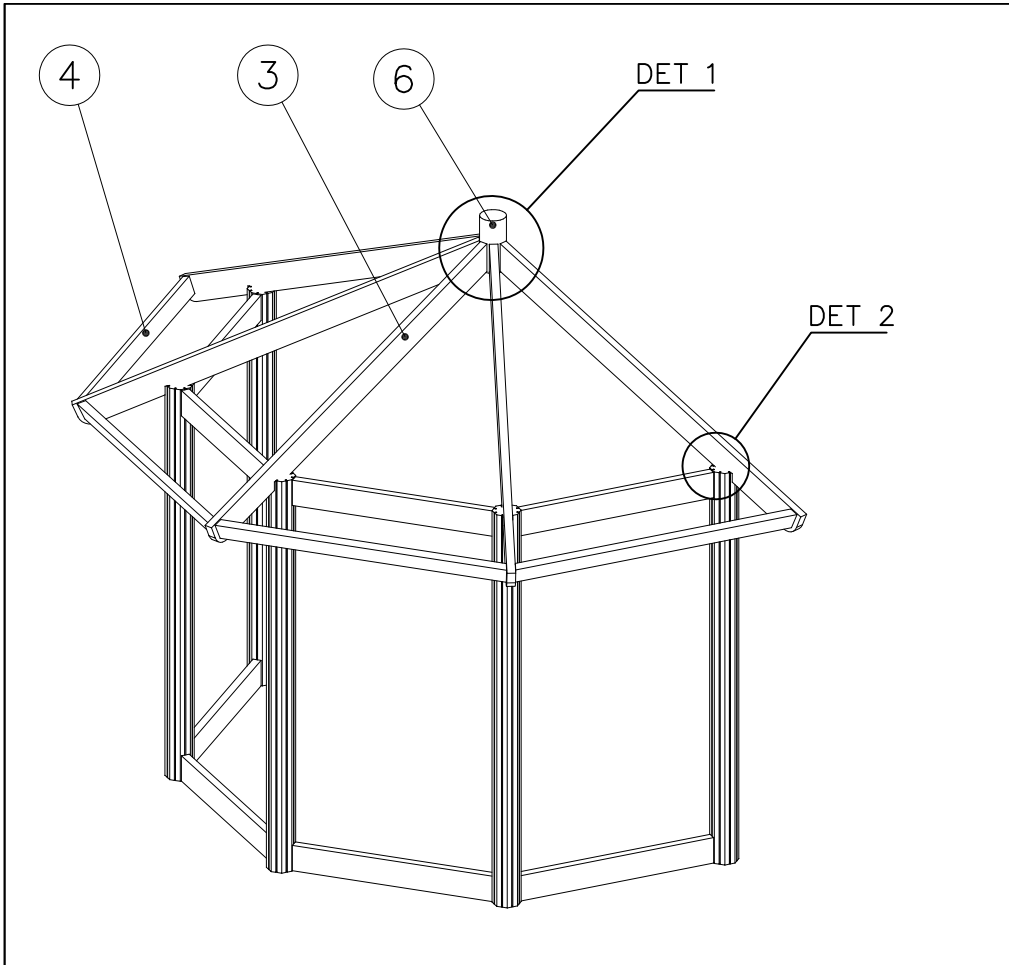

① 007493	PCS 4	② 007492	PCS 4
③ 007495	PCS 5	④ 007498	PCS 4
L 2297		L 1610	
⑤ 007496	PCS 5	⑥ 909666	PCS 1
L 2330			
⑦ 007499	PCS 1	⑧ 905139	PCS 1
		BLACK	

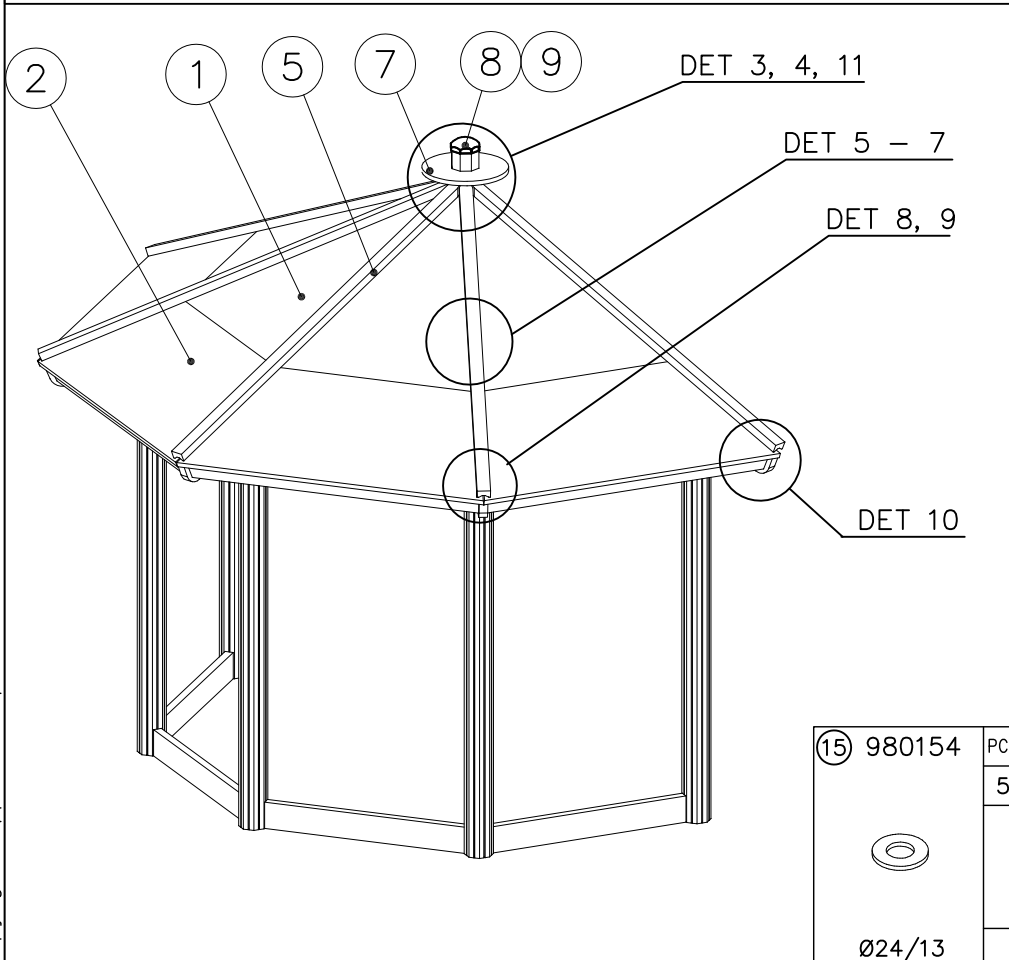

⑨ 905197	PCS 1	⑩ 909225	PCS 5
BLACK		12x180	
⑪ 980131	PCS 4	⑫ 908934	PCS 2
6x60		165mm/ 10m	
⑬ 980100	PCS 4	⑭ 980101	PCS 40
5x60		4.5x70	
⑮ 980154	PCS 5	⑯ 980104	PCS 8
Ø24/13		5x90	
		⑰ 980105	PCS 25
		5x120	

<p>DET 1</p> <p>909666 7495 M10</p>	<p>DET 2</p> <p>Ø24/13 12x180 7495 7303</p>	<p>DET 3</p> <p>7499 909666</p>
<p>DET 4</p> <p>5x60</p>	<p>DET 5</p> <p>7493 4.5x70 7495</p>	<p>DET 6</p> <p>7493 7492</p>
<p>DET 7</p> <p>7492 4.5x70</p>	<p>DET 8</p> <p>908934</p>	<p>DET 9</p> <p>5x120 7496</p>
<p>DET 10</p> <p>7498 5x90</p>	<p>DET 11</p> <p>6x60</p>	