

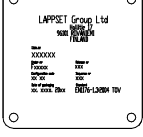

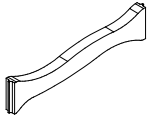

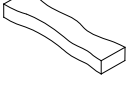



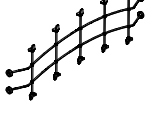

① 702286	PCS	② 705214	PCS
	1		2
65x65		L=724	
③ 705223	PCS	④ 706193	PCS
	5		4
70x145x600		L=946	
⑤ 708497	PCS	⑥ 708500	PCS
	2		2
68x120x2520		700x2400	
⑦ 980128	PCS	⑧ 903093	PCS
	10		20
Ø7x40		Ø8x90	
⑨ 905104	PCS	⑩ 909506	PCS
	16		4
M10		Ø3.5x13	
⑪ 909521	PCS	⑫ 980123	PCS
	4		50
		Ø7x60	
⑬ 980151	PCS	⑭ 909232	PCS
	4		4
Ø16/8.4		Ø8x120	
	PCS	⑮ 905103	PCS
			4
		PT-28/32-H	

<p>DET 1</p>	<p>DET 2</p>	<p>DET 3</p>
<p>DET 4</p>	<p>DET 5</p>	<p>DET 6</p>
<p>DET 7</p>	<p>DET 8</p>	<p>*note</p> <p>Rope elements are not symmetrical horizontally. When installing make sure there is larger gap between railing and net.</p>

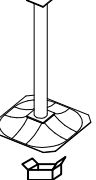

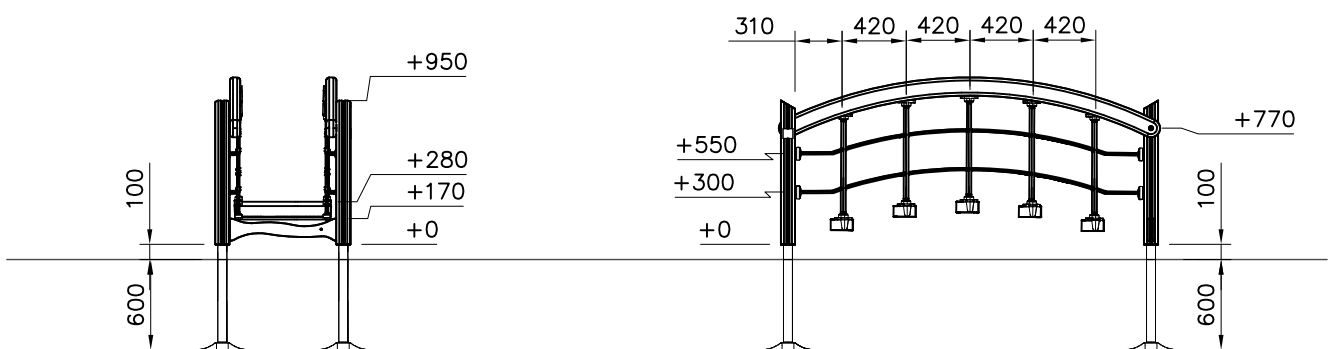

## Tuotekyltti tulee tuotteen mukana yhdellä seuraavista tavoista:

### 1) Metallinen tuotekyltti ja kiinnitysruuvit

- Kiinnitä tuotekyltti ruuveilla tolppaan noin 2 metrin korkeuteen kuvan 1 mukaisesti.

### 2) Tuotekylttitarra

- Puhdista maalattu metalli- tai vaneripinta pölystä ja kosteudesta. Liimaa tarra kuvan 2 mukaisesti.
- Huom. Älä kiinnitä tarraa karheapintaiseen laminaattiin tai maalattuun puuhun.

## Vår produktmärkning levereras på ett av följande sätt:

### 1) Produktskylt i metall

- Fäst skylten med de medföljande skruvarna

### 2) Självhäftande produktetikett

- Rengör den pulverlackerade metallytan eller laminatyten så att den blir fri från smuts och fukt. Fäst etiketten enligt fig. 2.
- Obs! Fäst ej etiketten på detaljer med skrovlig yta eller på målat trä.

## Product label is delivered by one of following ways:

### 1) Metal product label and screws

- Fasten the label with screws.

### 2) Label sticker

- Clean the painted metal or plywood surface from dirt and moisture. Fasten the sticker as shown in the figure 2.
- Note. Do not attach the sticker to rough surfaced laminate or painted wood.

## La plaque d'informations produit est livrée sous l'une de ces 3 formes :

### 1) Plaque métallique et vis

- Fixez la plaque à l'aide des vis.

### 2) Etiquette autocollante

- Avant de coller l'étiquette, nettoyez le composant métallique peint ou la plaque de contreplaqué, de toute saleté. La surface doit être sèche (voir image 2).
- Attention, ne pas coller l'étiquette sur une surface lamellé-collée irrégulière ou sur du bois peint.

## Die Auslieferung des Produktaufklebers erfolgt auf eine dieser Arten:

### 1) Produkt-Schild aus Metall incl. Schrauben

- Die Befestigung des Schildes erfolgt mittels der Schrauben.

### 2) Aufkleber

- Entfernen Sie zunächst Schmutz und Feuchtigkeit vom lackierten Metall bzw. von der Holzoberfläche und bringen Sie den Aufkleber wie im Bild oben rechts beschrieben auf den gesäuberten Untergrund auf.
- Beachten Sie: Bringen Sie den Aufkleber nicht auf raues laminiertes oder lackiertes Holz an.



①	909511	PCS	②	909519	PCS
		1			1
③	909637	PCS	④	909638	PCS
		4			8
	M10			Ø20/10.5	
⑤	909639	PCS			PCS
		4			
	M10x25				
		PCS			PCS
		PCS			PCS
		PCS			PCS
		PCS			PCS
		PCS			PCS

DET 1

