







L'ARBRE DE LA CHOUETTE



-  DES PONTS
1
-  Éléments à grimper
3
-  NUMBER OF PLAY
1
-  Toits
2
-  Toboggans
1
-  Tours
2



Structure de jeux composée de 2 tours, sans toboggan, offrant de nombreuses possibilités de grimpe.

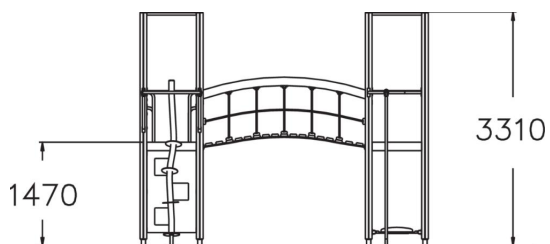
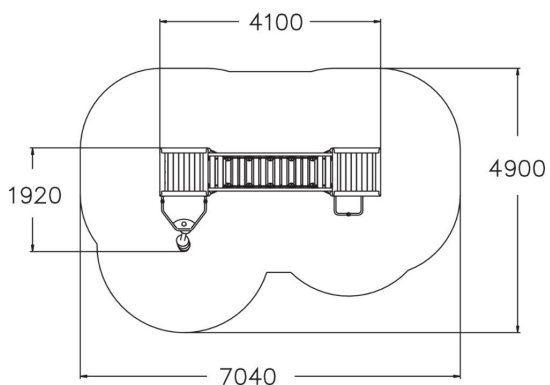

TRANCHE D'ÂGES	4
NOMBRE D'UTILISATEURS	10
Longueur du produit (mm)	4100
Largeur du produit (mm)	1920
Hauteur du produit (mm)	3310
Impact area (m2)	28.1
Surface zone de sécurité FR (m2)	262
Hauteur minimum requise (mm)	3310
Hauteur de chute libre (mm)	1470
Certificats	EN 1176-1 TÜV
TEMPS DE MONTAGE POUR 2 PERSON, H	2
Options de fondation	Deep mounting Surface mounting