

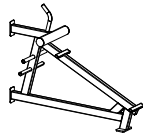









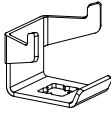
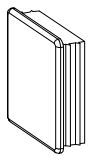
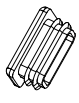

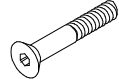



① 911842  1	② 911837  1	③ 710067  1	④ 911928  1	⑤ 910405  1	⑥ 911764  6 SR-H-2040
⑦ 905103  PT-28/32-H 11	⑧ 909854  M8x50 6	⑨ 909256  Ø16/8.4x1.6 8	⑩ 909633  M8 8	⑪ 980165  Ø24/13 9	⑫ 912127  M12x110 5
⑬ 909644  M12 7	⑭ 912575  M8x110 2	⑮ 904450  M16x170 4	⑯ 909628  M10x100 8	⑰ 910376  Ø30x17 14	⑱ 710483  118x78 1
⑲ 902096  M12x120 2	⑳ 710472  118x78 1	㉑ 912500  Ø4.8x14 12	㉒ 710484  118x78 1	㉓ 911843  1	㉔ 912515  1
			㉕ 910416  Ø48/43-45x24 2	㉖ 710485  118x78 1	㉗ 702341  90x50 1

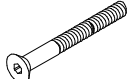

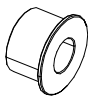
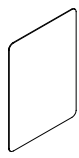

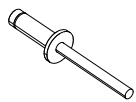
Area of Movement 20.1 m<sup>2</sup>  
 Training Space 7.7 m<sup>2</sup>  
 Max Falling Height 480 mm

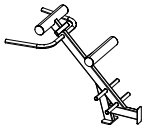
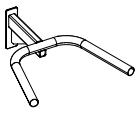
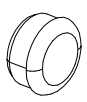
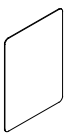
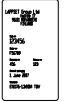
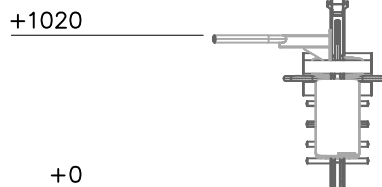
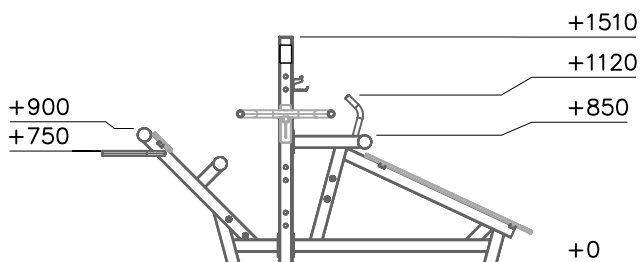
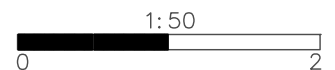
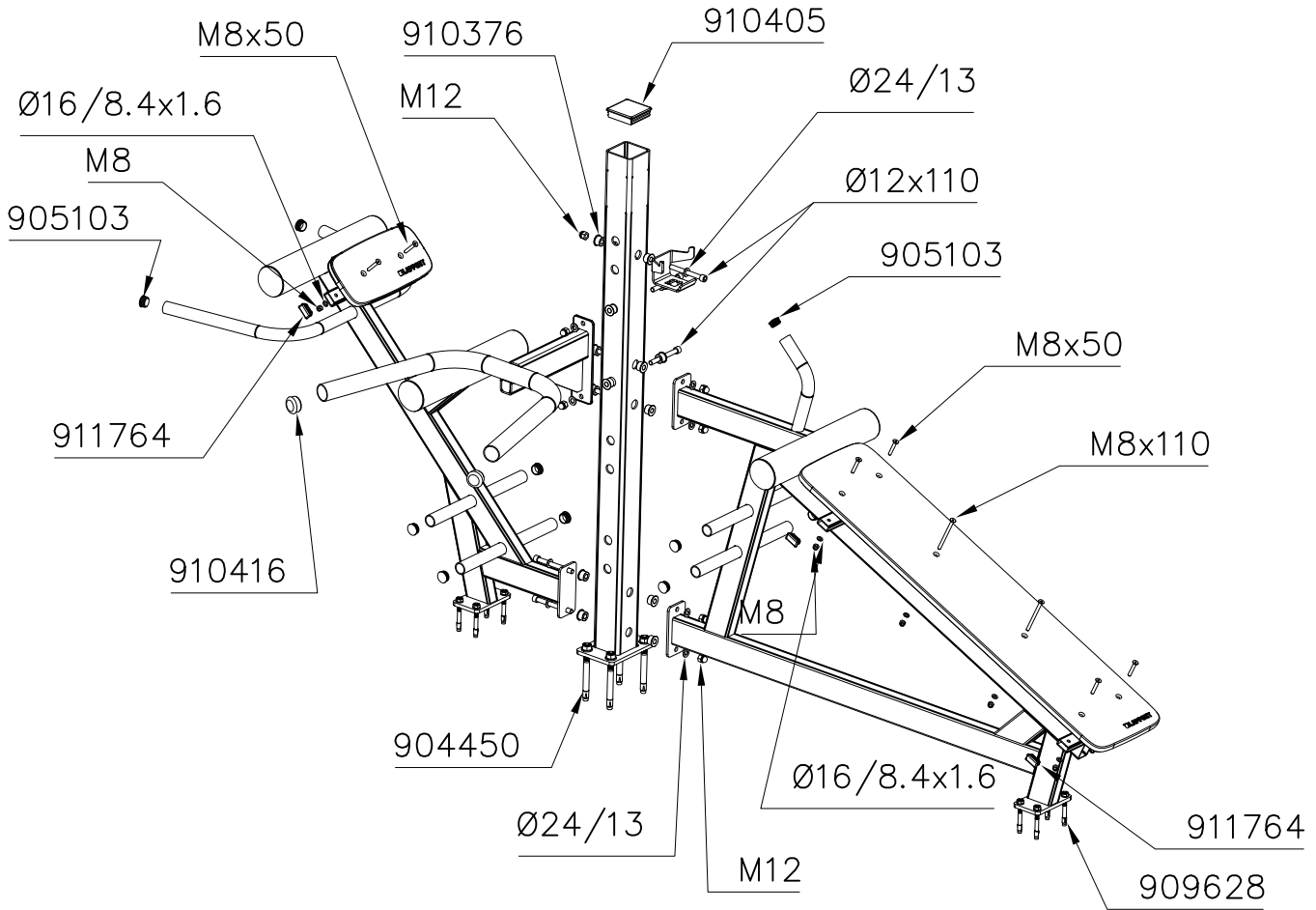
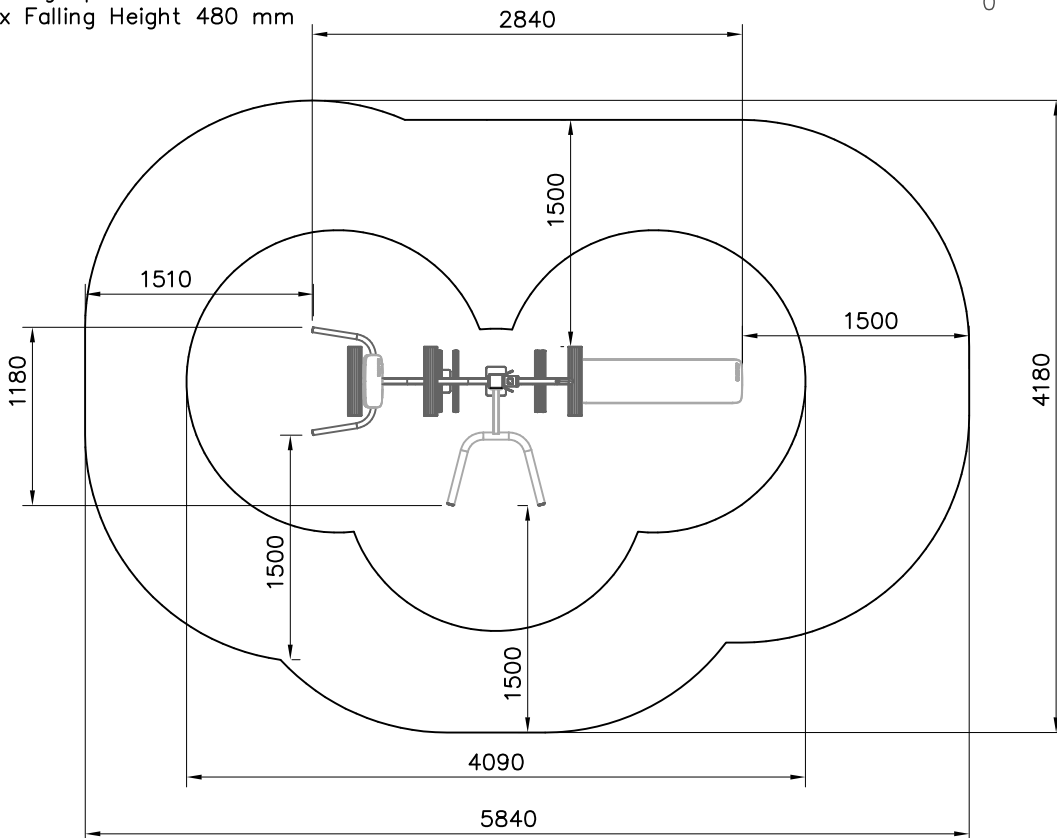
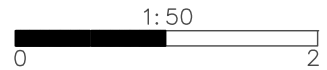

DET 1

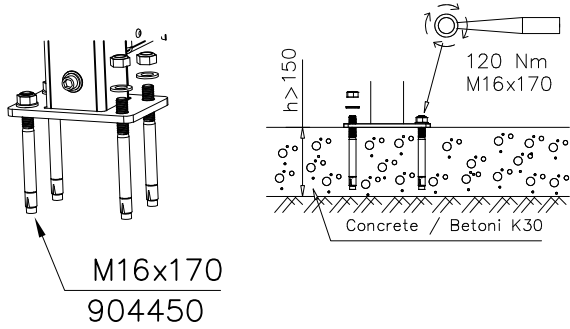

DET 2

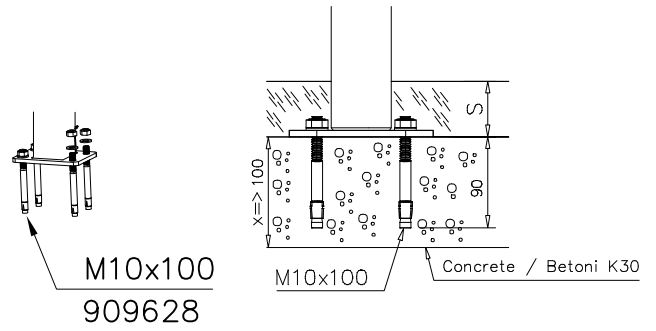

When using concrete slab

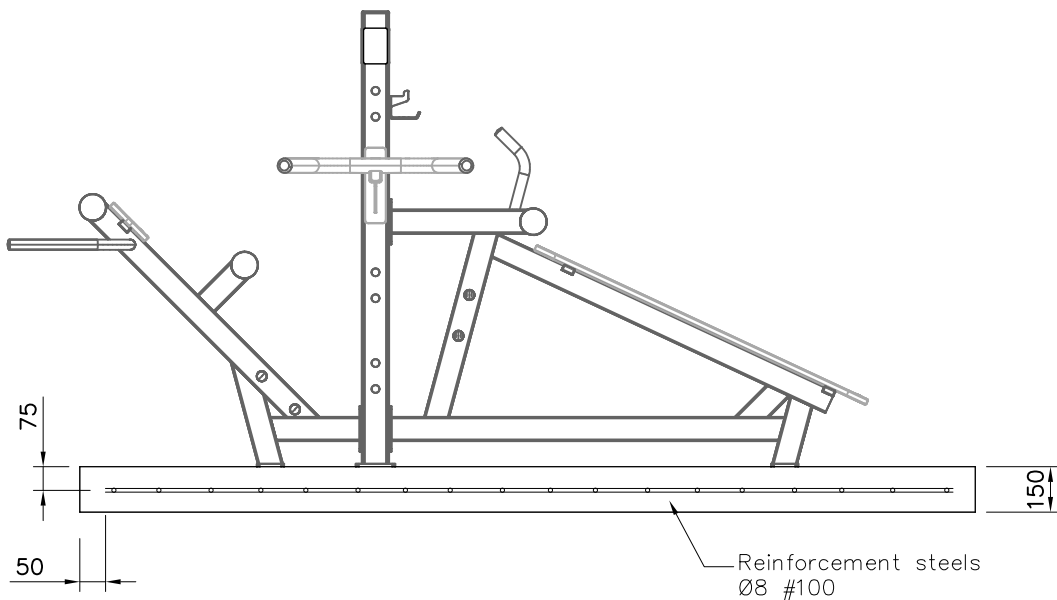
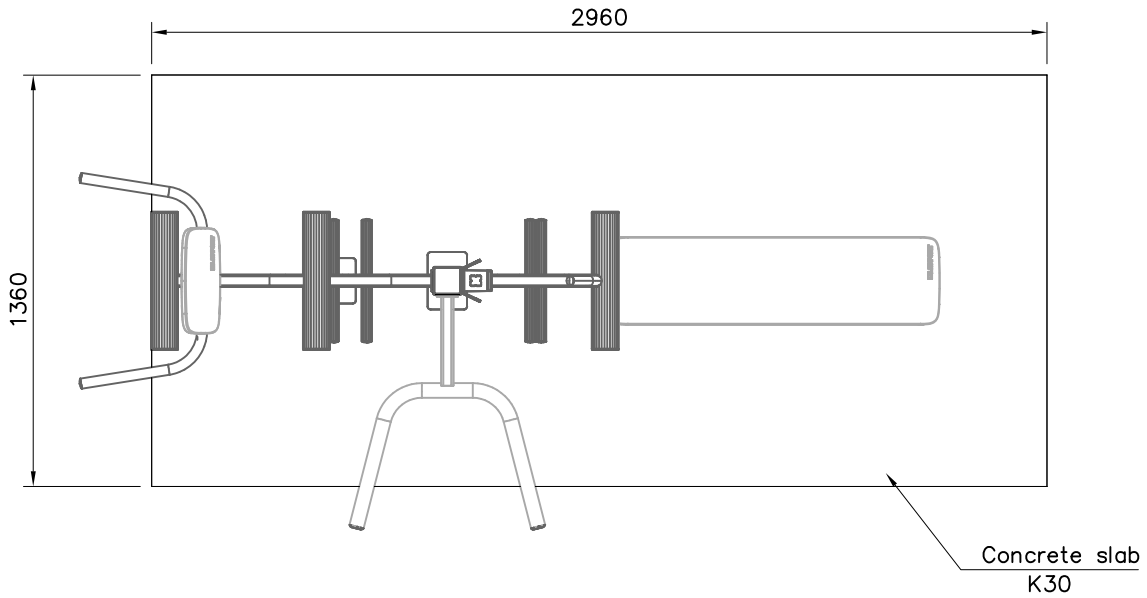



## Tuotekyltti tulee tuotteen mukana yhdellä seuraavista tavoista:

### 1) Metallinen tuotekyltti ja kiinnitysruuvit

- Kiinnitä tuotekyltti ruuveilla tolppaan noin 2 metrin korkeuteen kuvan 1 mukaisesti.

### 2) Tuotekylttitarra

- Puhdista maalattu metalli- tai vaneripinta pölystä ja kosteudesta. Liimaa tarra kuvan 2 mukaisesti.
- Huom. Älä kiinnitä tarraa karheapintaiseen laminaattiin tai maalattuun puuhun.

## Vår produktmärkning levereras på ett av följande sätt:

### 1) Produktskylt i metall

- Fäst skylten med de medföljande skruvarna

### 2) Självhäftande produktetikett

- Rengör den pulverlackerade metallytan eller laminatyten så att den blir fri från smuts och fukt. Fäst etiketten enligt fig. 2.
- Obs! Fäst ej etiketten på detaljer med skrovlig yta eller på målat trä.

## Product label is delivered by one of following ways:

### 1) Metal product label and screws

- Fasten the label with screws.

### 2) Label sticker

- Clean the painted metal or plywood surface from dirt and moisture. Fasten the sticker as shown in the figure 2.
- Note. Do not attach the sticker to rough surfaced laminate or painted wood.

## La plaque d'informations produit est livrée sous l'une de ces 3 formes :

### 1) Plaque métallique et vis

- Fixez la plaque à l'aide des vis.

### 2) Etiquette autocollante

- Avant de coller l'étiquette, nettoyez le composant métallique peint ou la plaque de contreplaqué, de toute saleté. La surface doit être sèche (voir image 2).
- Attention, ne pas coller l'étiquette sur une surface lamellé-collée irrégulière ou sur du bois peint.

## Die Auslieferung des Produktaufklebers erfolgt auf eine dieser Arten:

### 1) Produkt-Schild aus Metall incl. Schrauben

- Die Befestigung des Schildes erfolgt mittels der Schrauben.

### 2) Aufkleber

- Entfernen Sie zunächst Schmutz und Feuchtigkeit vom lackierten Metall bzw. von der Holzoberfläche und bringen Sie den Aufkleber wie im Bild oben rechts beschrieben auf den gesäuberten Untergrund auf.
- Beachten Sie: Bringen Sie den Aufkleber nicht auf raues laminiertes oder lackiertes Holz an.