

LAPPSET®

FITNESS

ASENNUSOHJE
MONTERINGSANSVISNING
INSTALLATION INSTRUCTION
AUFBAUANLEITUNG
NOTICE D'INSTALLATION

DATE: 14.9.2023







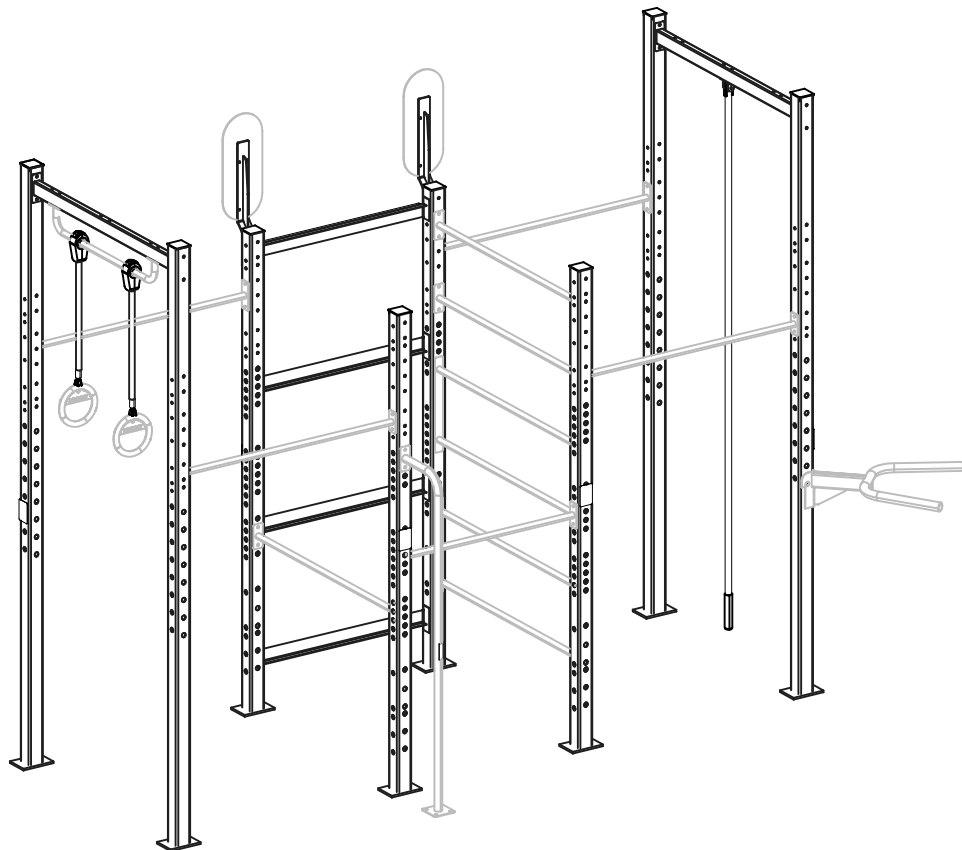



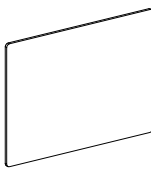
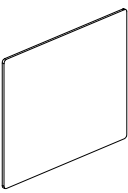
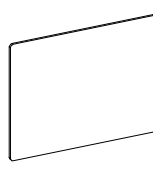



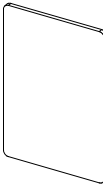

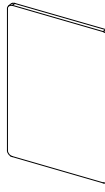





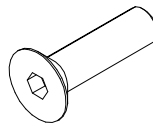
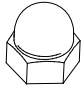
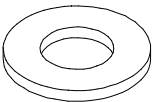
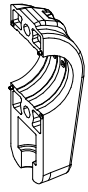
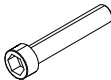

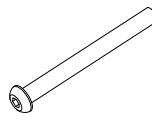
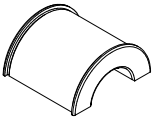
Fitness equipment is not intended for installation in the immediate vicinity of children's playgrounds in accordance with EN 1176.

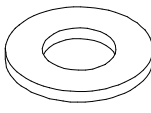

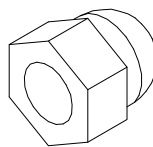
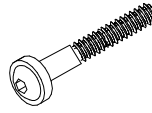
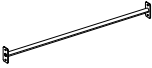
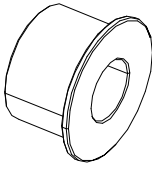
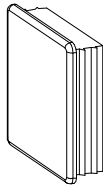

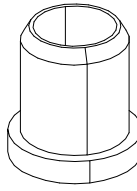
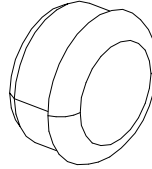
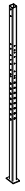
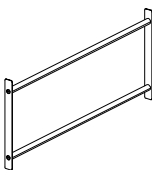
Kuntolaitteita ei ole tarkoitettu asennettaviksi lasten leikkikentän välittömään läheisyyteen standardin EN 1176 mukaisesti.

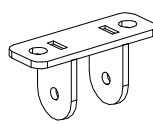
081850

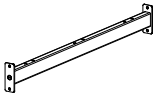
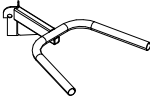

DATE: 14.9.2023

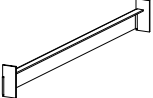
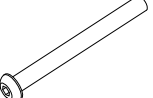
702341  90x50	PCS 1	708799-704  15x1050x798	PCS 1	708800-704  15x1050x798	PCS 1	708801-704  15x1050x798	PCS 1	708811  Ø32x3050	PCS 1	709733  118x78	PCS 1
709734  118x78	PCS 1	709736  118x78	PCS 1	709737  118x78	PCS 1	709738  118x78	PCS 1	709739  118x78	PCS 1	710040  118x78	PCS 1
710041  118x78	PCS 1	710486  Ø16x974	PCS 2	711405  118x78	PCS 1	900348  M8x30	PCS 24	900965  M10	PCS 88	901302  Ø20/10.5x2	PCS 146
902195  150x50x50	PCS 4	902232  M10x55	PCS 2	902233  M10x30	PCS 2	904450  M16x170	PCS 32	904917  M10x100	PCS 6	906006  Ø64/36,4x59	PCS 4
906598  366x50	PCS 1	909256  Ø16/8.4x1.6	PCS 29	909628  M10x100	PCS 4	909633  M8	PCS 25	909867  M8x70	PCS 1	910368-224  1315	PCS 2
910376  Ø30x17	PCS 68	910405  90x90x30	PCS 9	910410-222  90x90x2720	PCS 4	910415  Ø16/12,5-14x17	PCS 208	910416  Ø48/43-45x24	PCS 2	910427-222  90x90x3400	PCS 4
910442-224  1315	PCS 2	910444-224  1315x160	PCS 4	910447-224  1315x160	PCS 1	910448-222  110x38x55	PCS 1	910455-224  1315x160	PCS 1	910459-224  1060	PCS 1

910614-222	PCS	910619-224	PCS	910622-224	PCS	910626-222	PCS	911149	PCS	912578	PCS
	2		1		1		1		78		2
1315		45°		1315		1060		M10x110			
	PCS		PCS		PCS		PCS		PCS		PCS
	PCS		PCS		PCS		PCS		PCS		PCS
	PCS		PCS		PCS		PCS		PCS		PCS
	PCS		PCS		PCS		PCS		PCS		PCS
	PCS		PCS		PCS		PCS		PCS		PCS

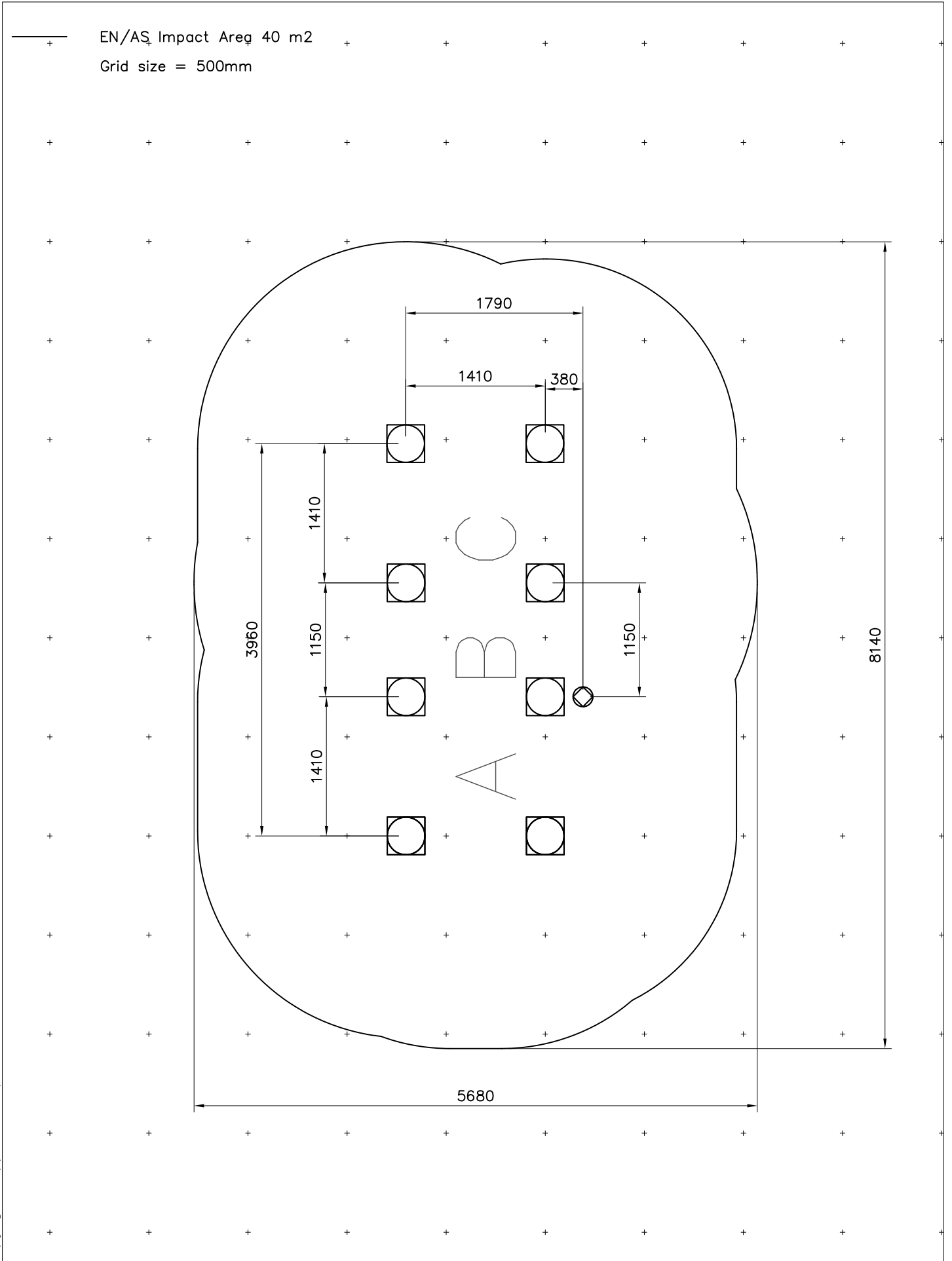

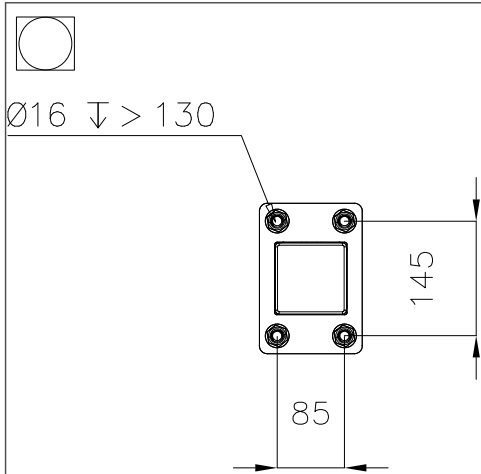
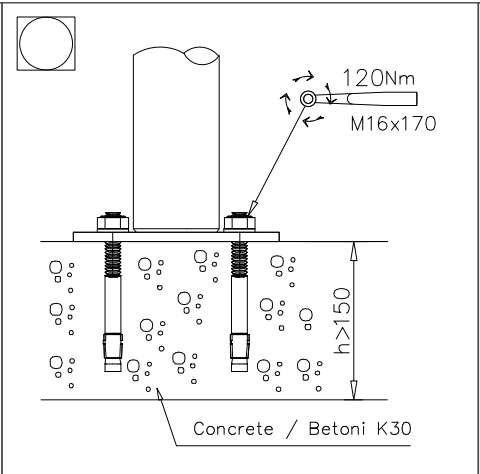
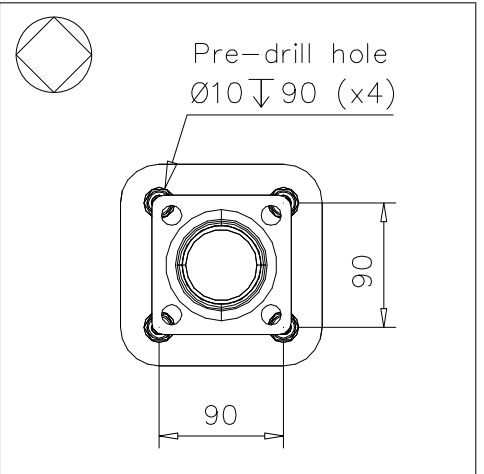
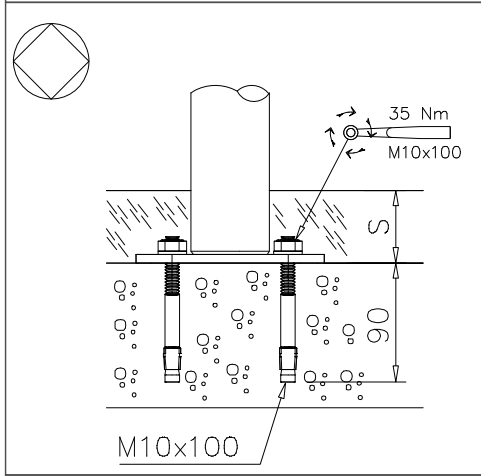
 <p>Ø16 \downarrow > 130</p> <p>145</p> <p>85</p>	 <p>120Nm</p> <p>M16x170</p> <p>h > 150</p> <p>Concrete / Betoni K30</p>	 <p>Pre-drill hole Ø10 \downarrow 90 (x4)</p> <p>90</p> <p>90</p>
 <p>35 Nm</p> <p>M10x100</p> <p>S</p> <p>90</p> <p>M10x100</p>		

Concrete foundation plans
 1pcs 200x500x4500
 1pcs 200x500x4500 + extension 330x430

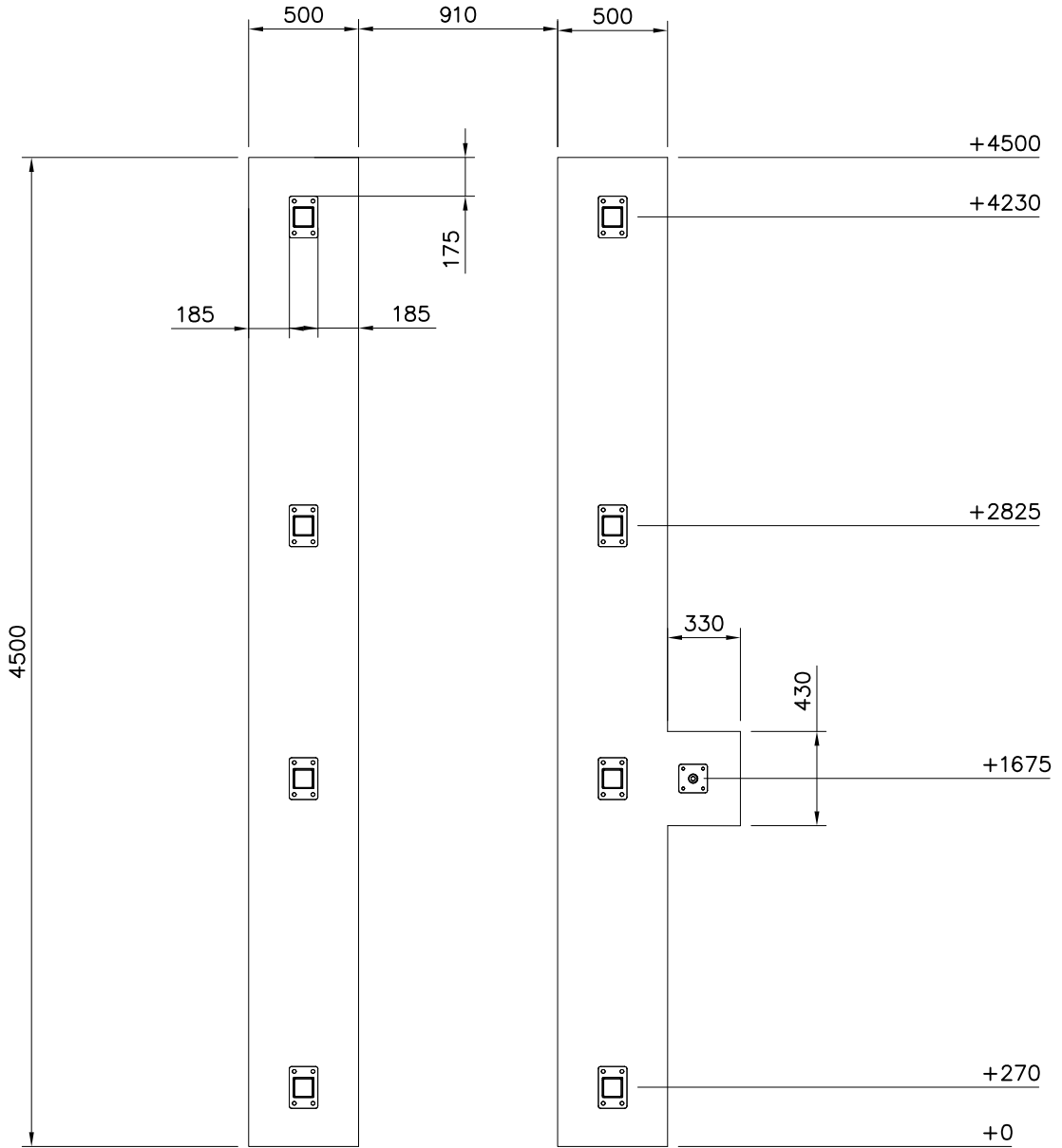

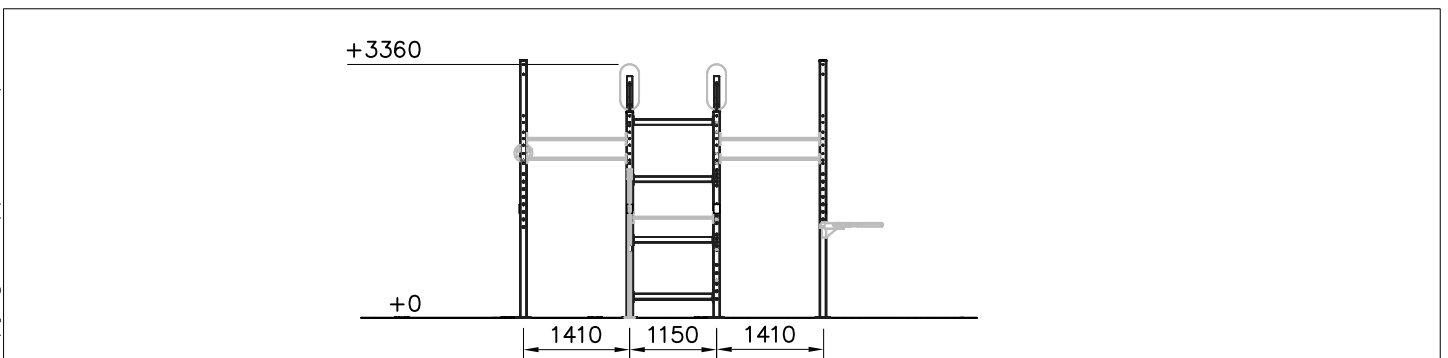
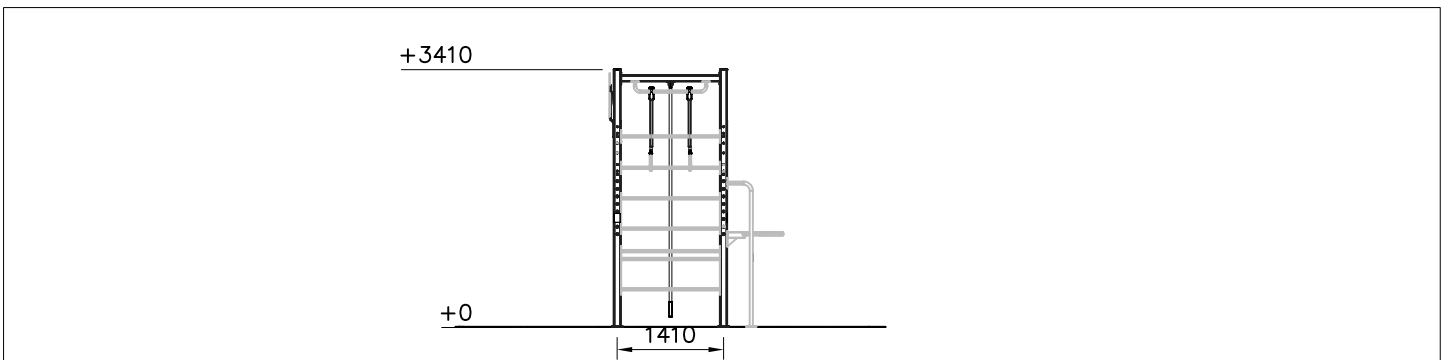
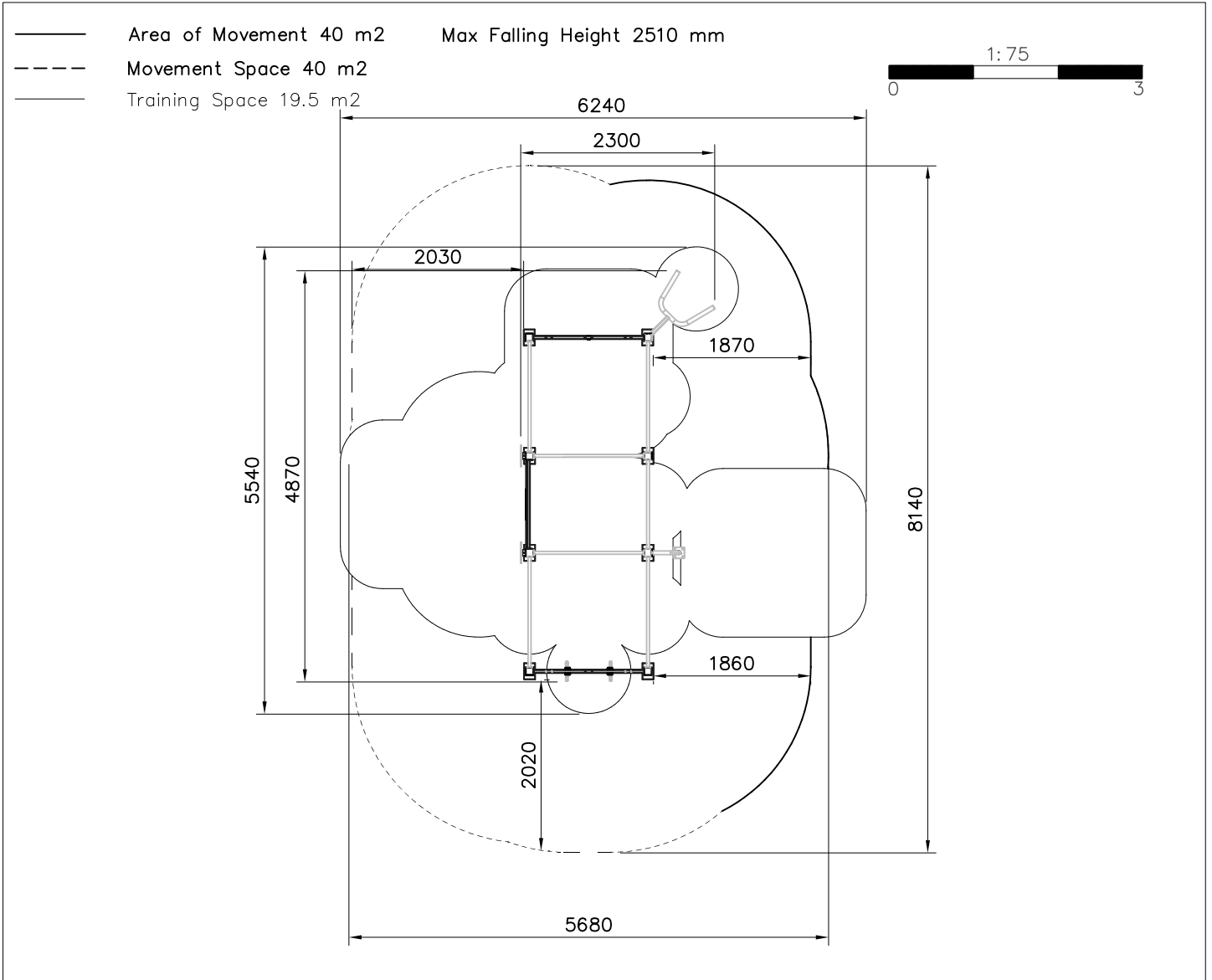

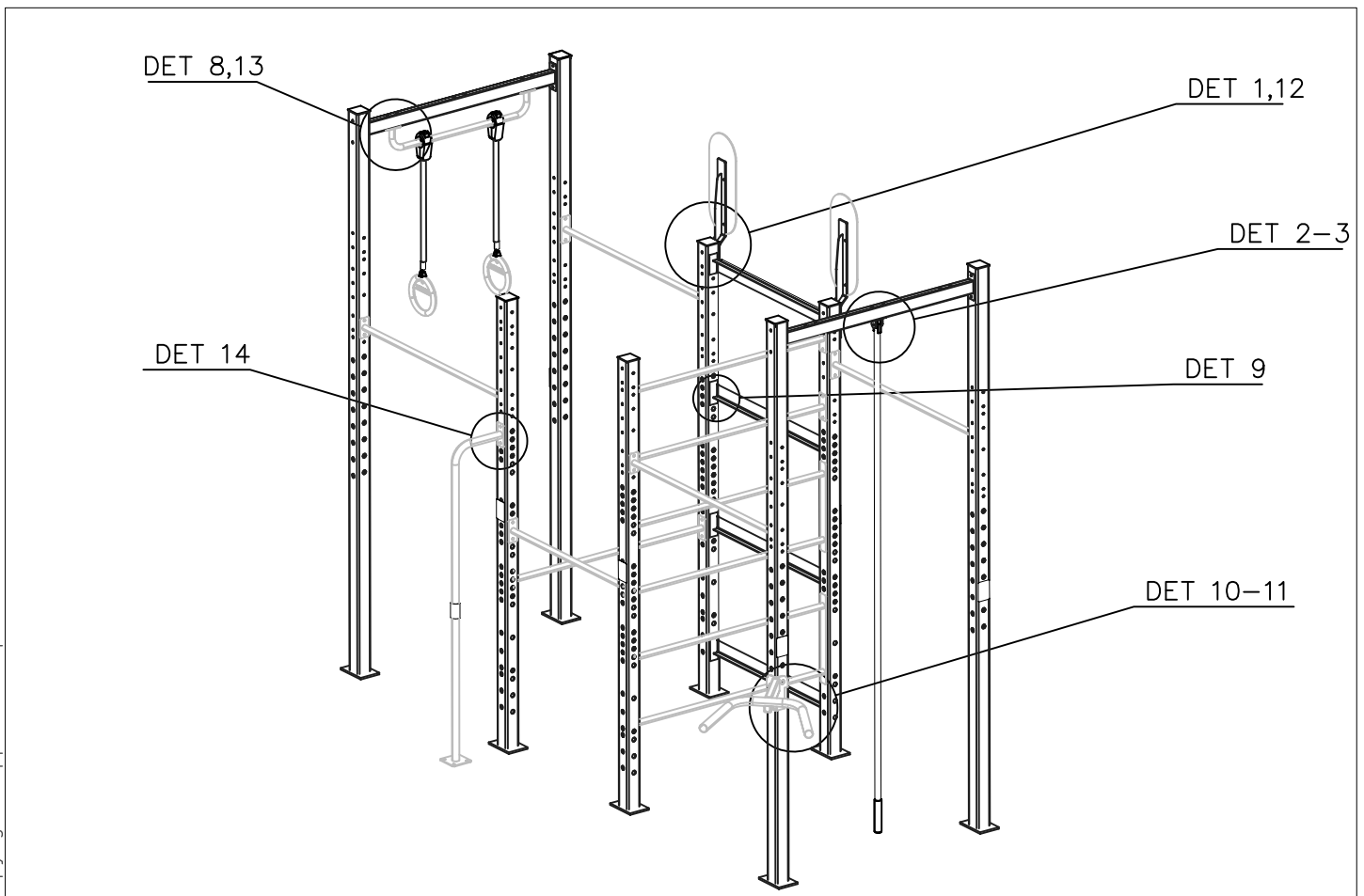
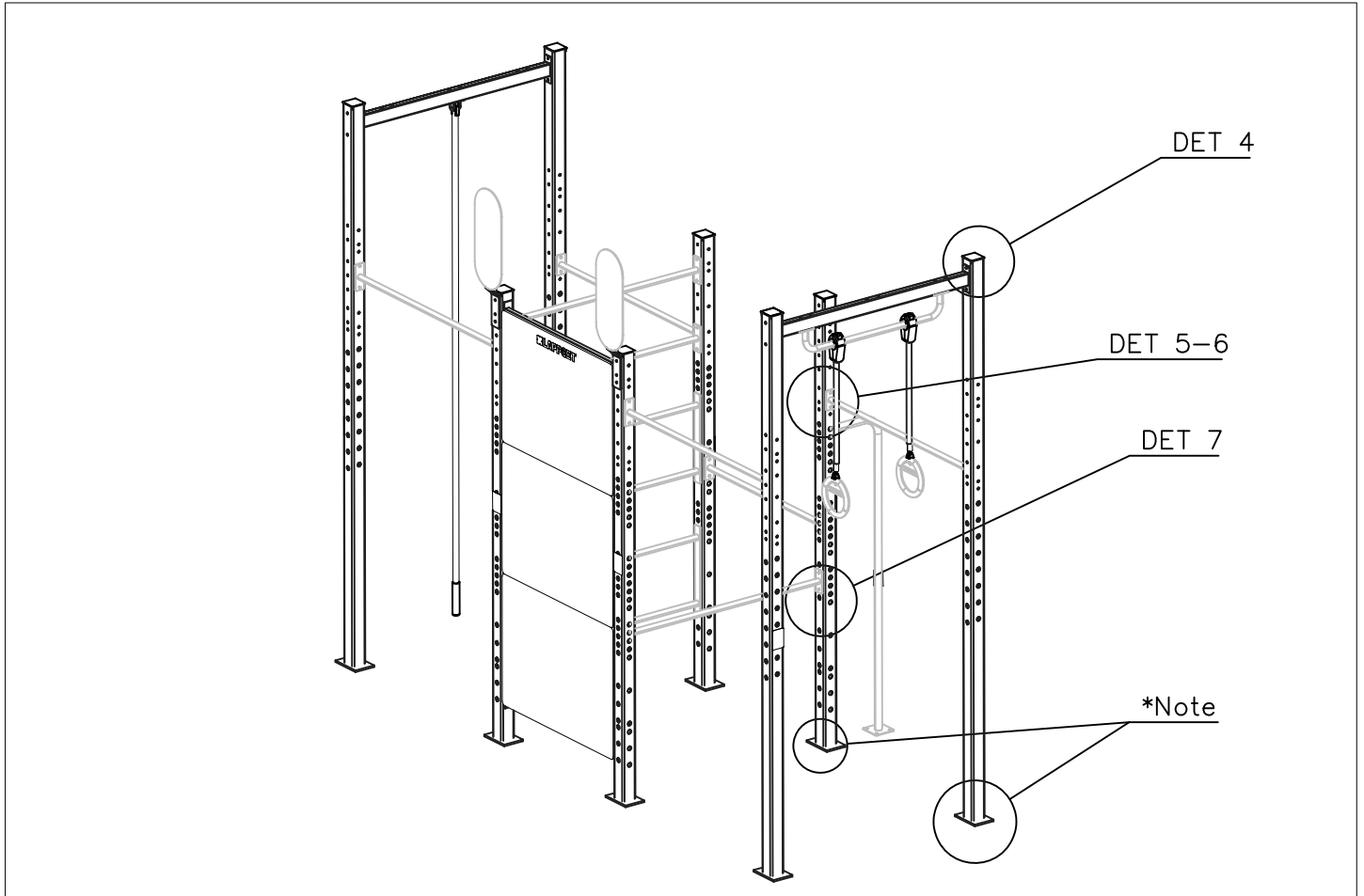

<p>DET 1</p>	<p>DET 2</p>	<p>DET 3</p>	<p>DET 4</p>
<p>DET 5</p>	<p>DET 6</p> <p>Plug the unused 13mm holes in the posts and beams with the plugs (910415)</p> <p>Tuki käyttämättömät 13mm reiät puomeissa ja tulpissa tulpilla (910415)</p>	<p>DET 7</p> <p>When installing elements in the 26mm holes use the bushings (910376) on both sides of the post</p> <p>26mm reikiin asennettaessa käytä puslia (910376) toipan molemmin puolin</p>	<p>DET 8</p>
<p>DET 9</p>	<p>DET 10</p>	<p>DET 11</p>	<p>DET 12</p>
<p>DET 13</p>	<p>DET 14</p>	<p>*Note</p> <p>All the post flanges are in the same direction</p> <p>Kaikki pylväiden jalat ovat samansuuntaisesti</p>	

DATE: 14.9.2023

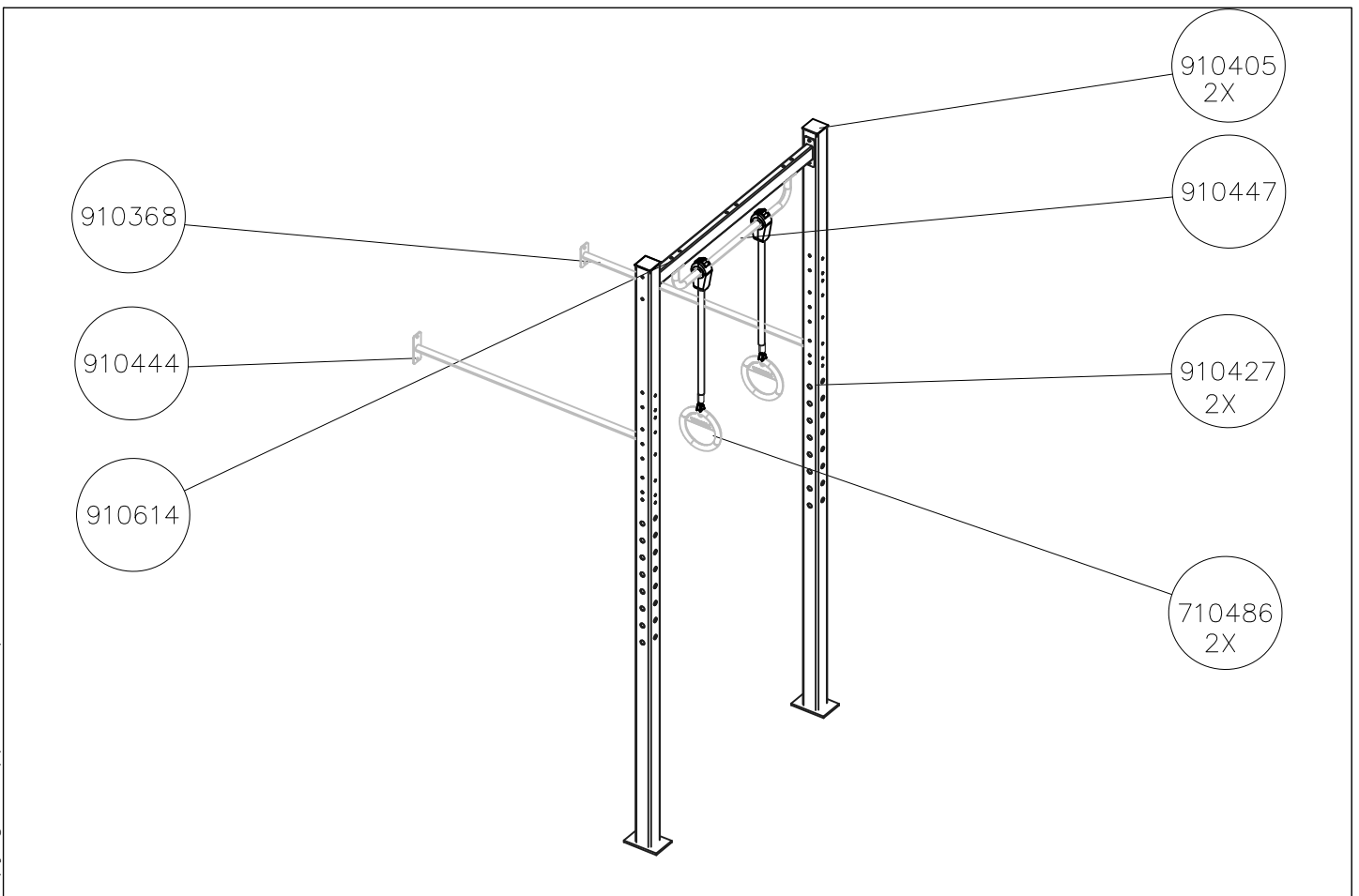
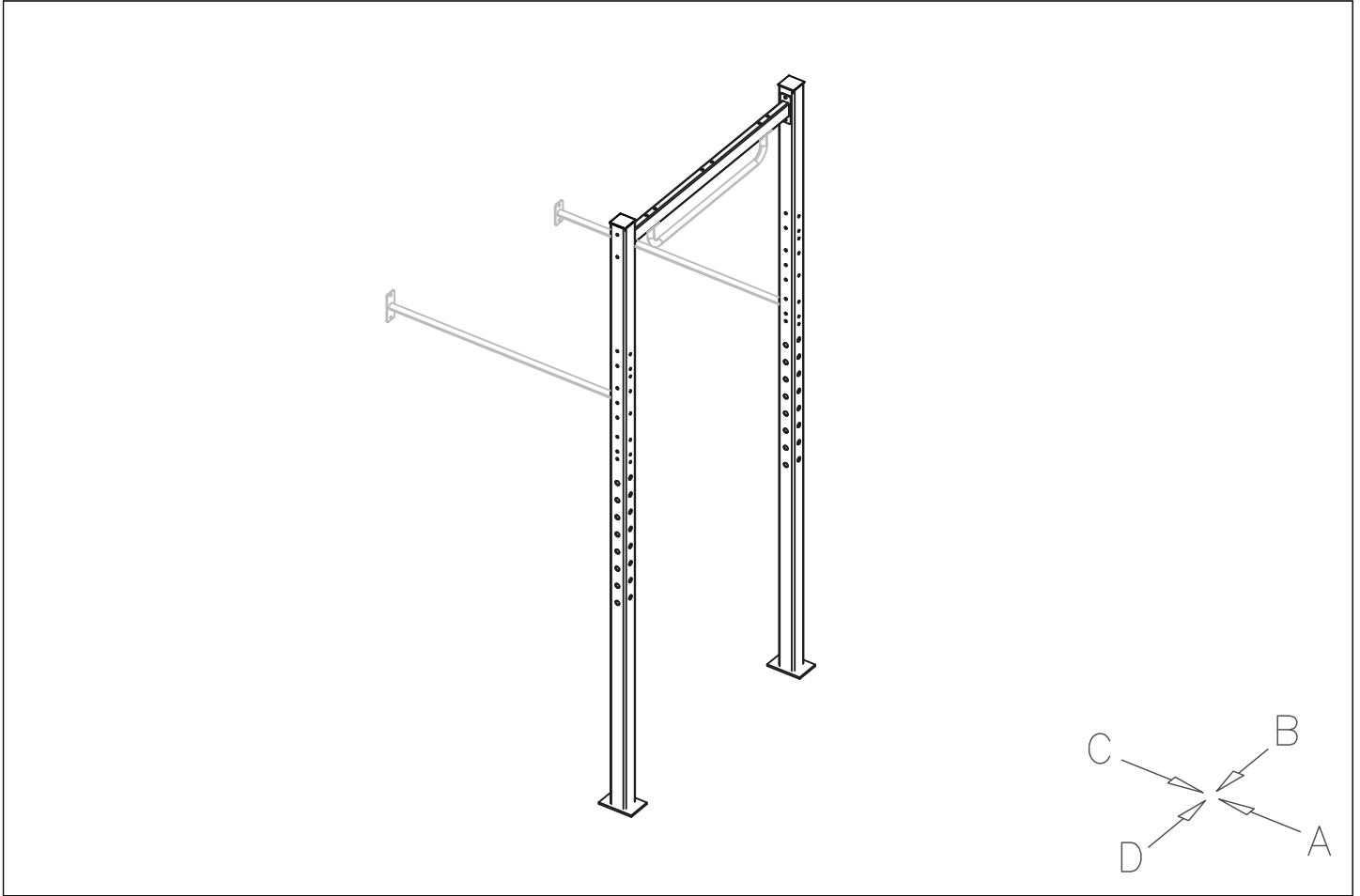

DATE: 14.9.2023

1:50

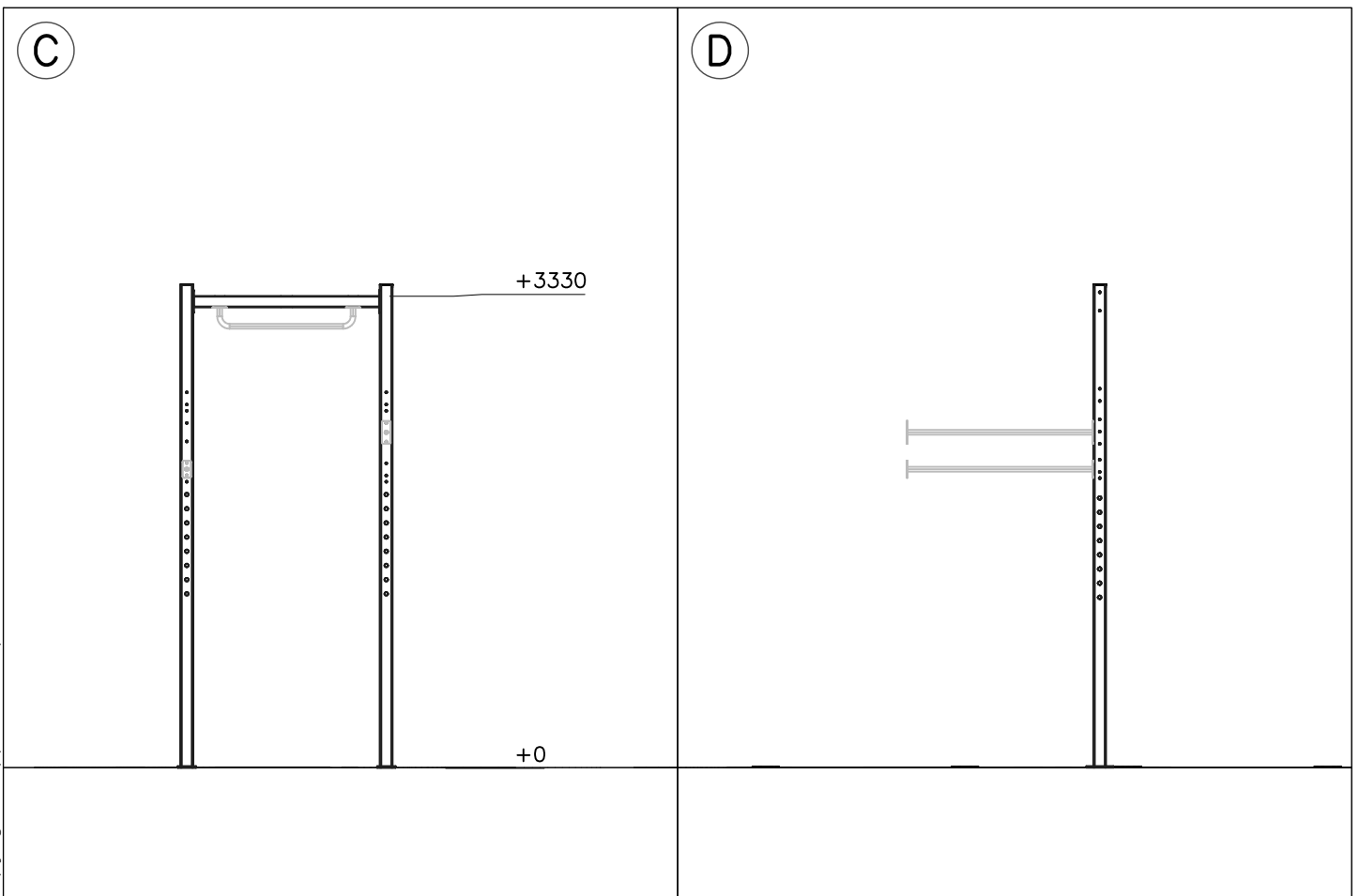
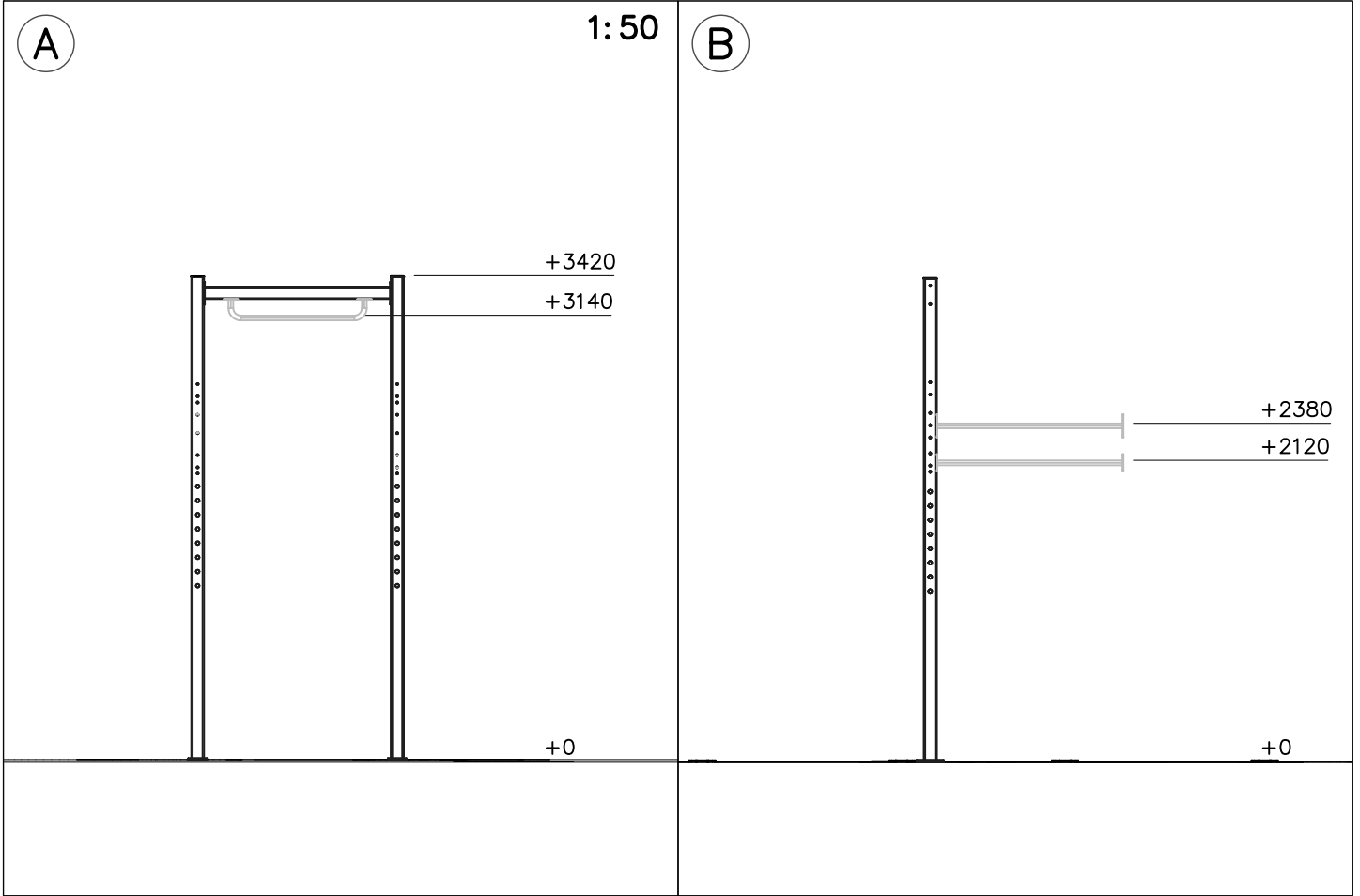

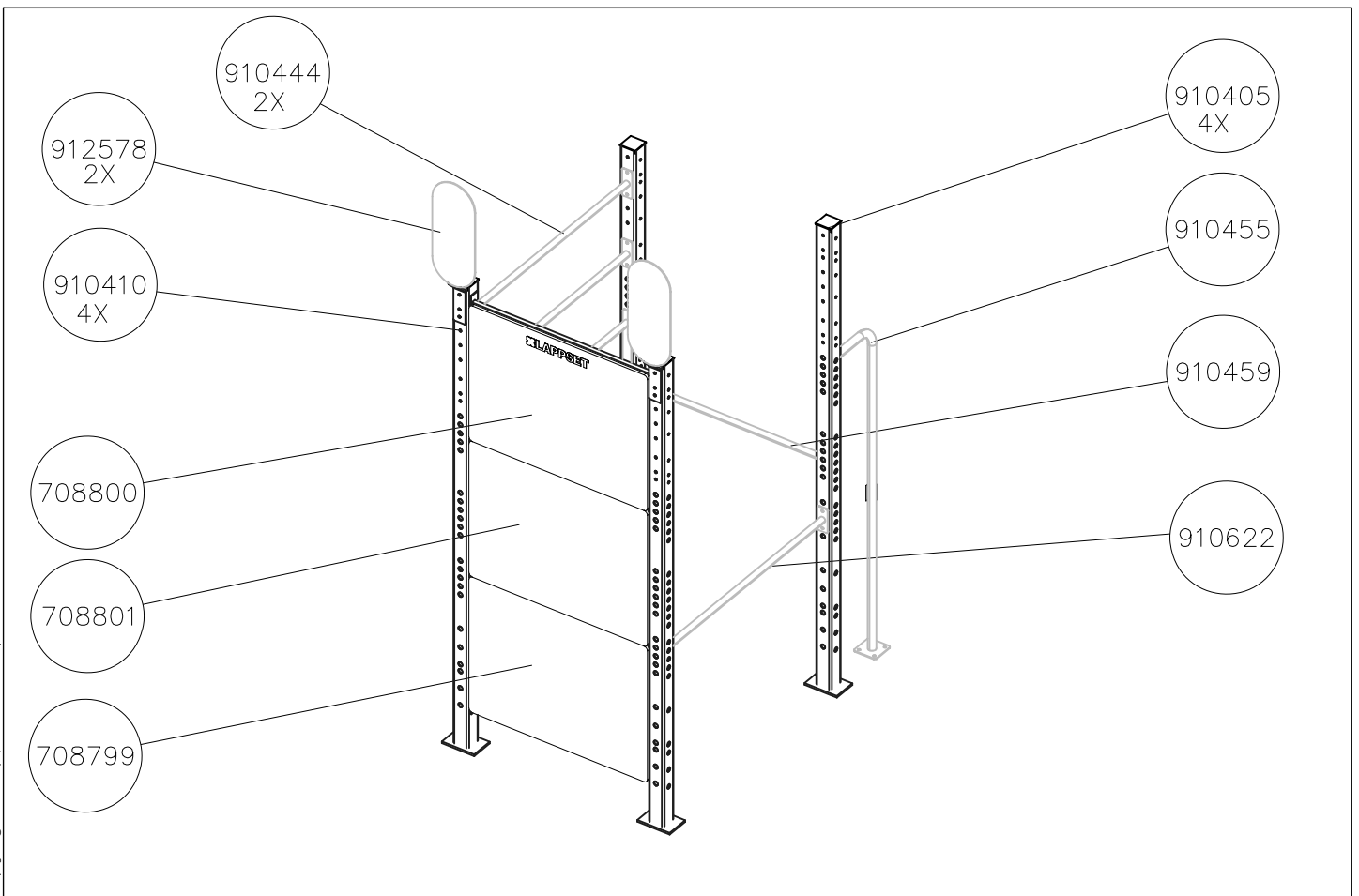
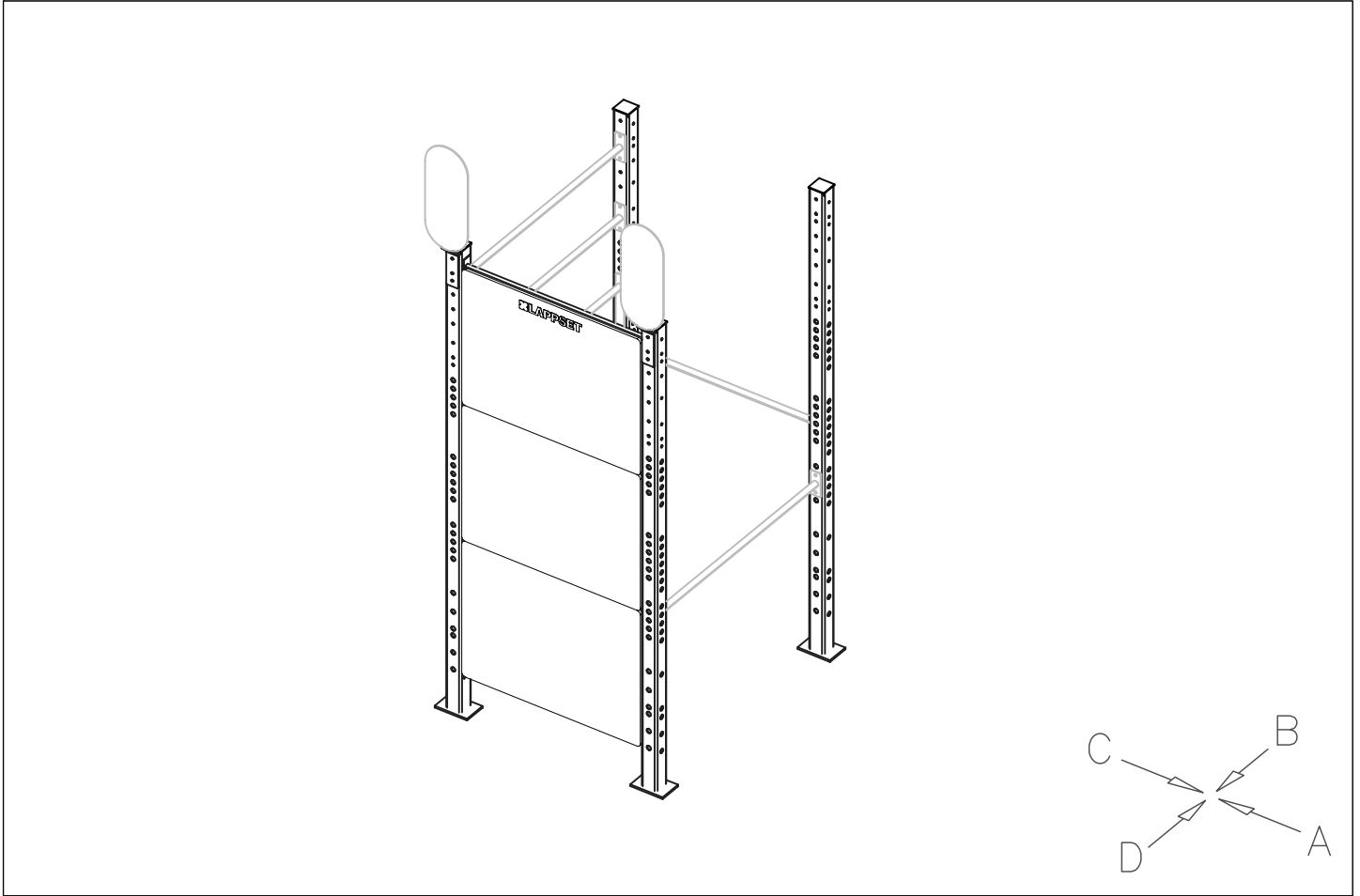

DATE: 14.9.2023

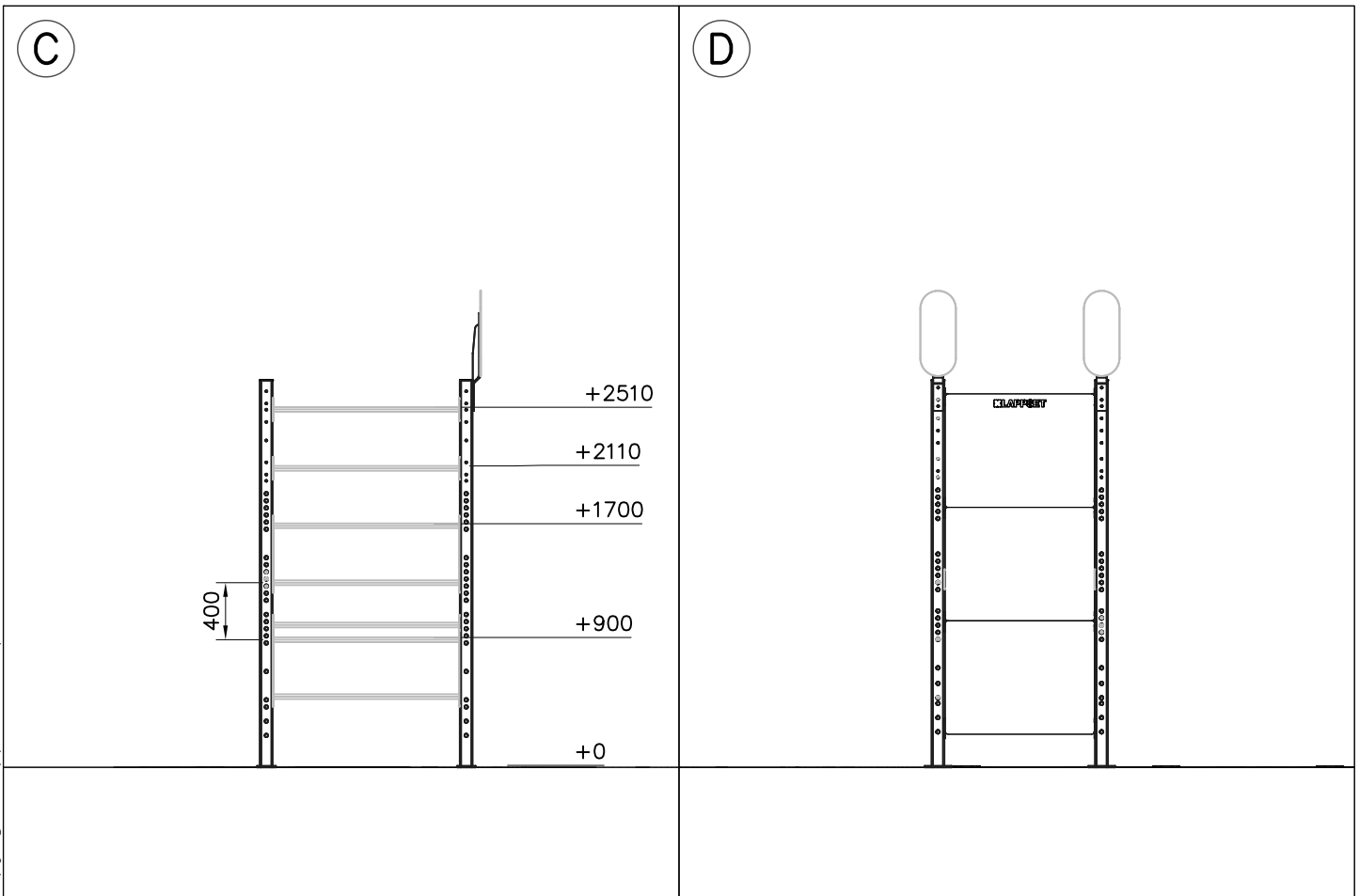
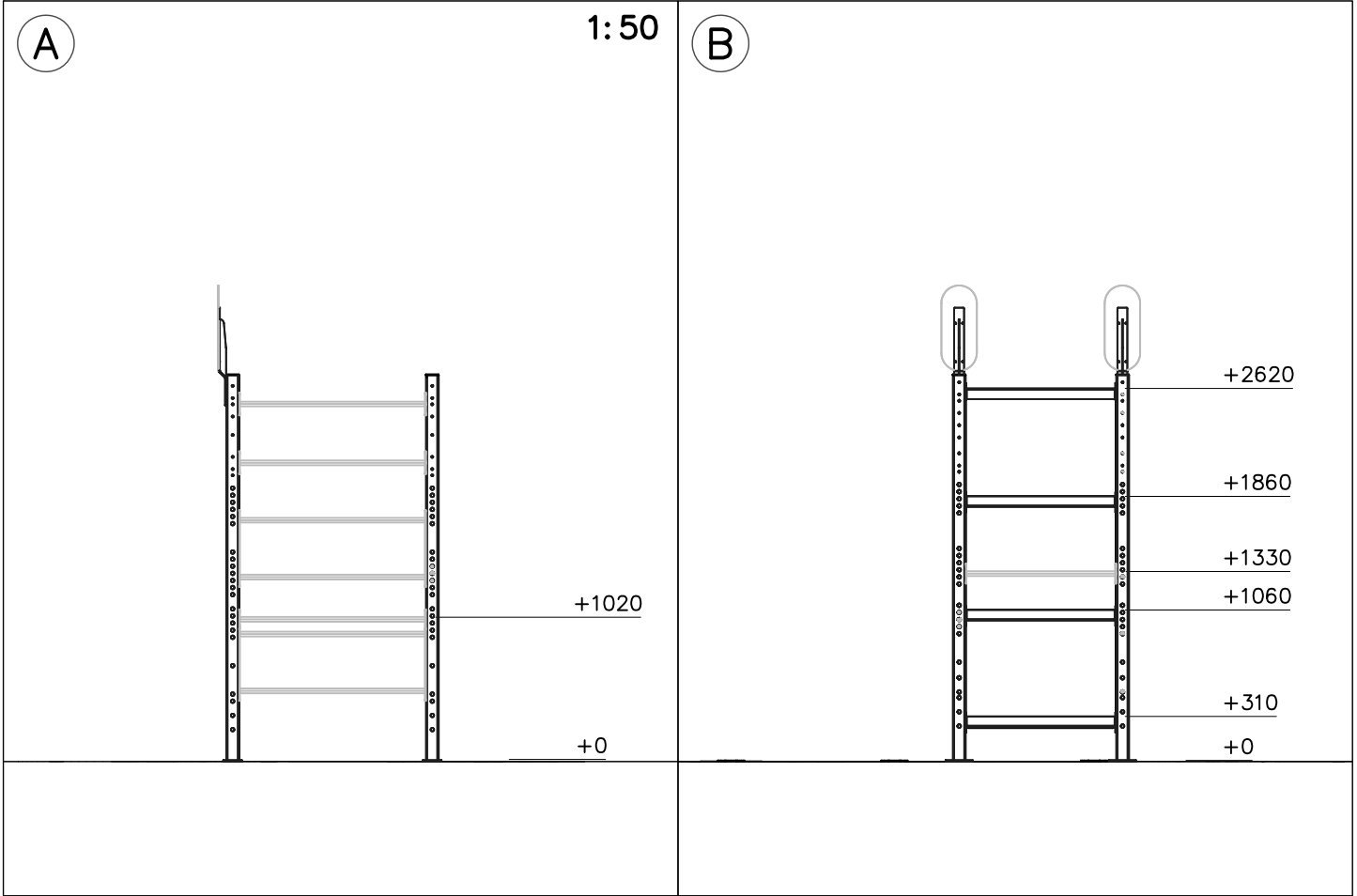

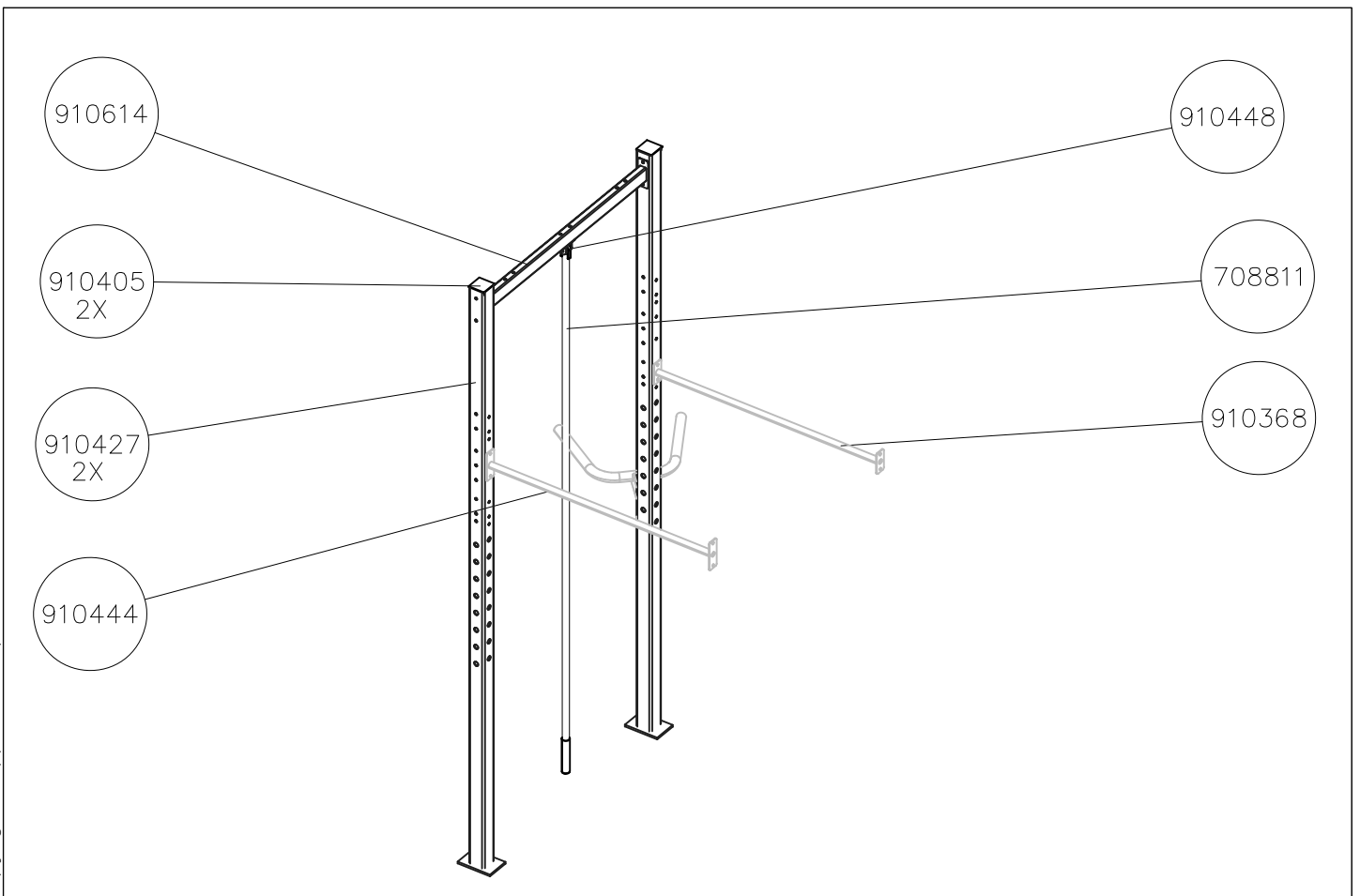
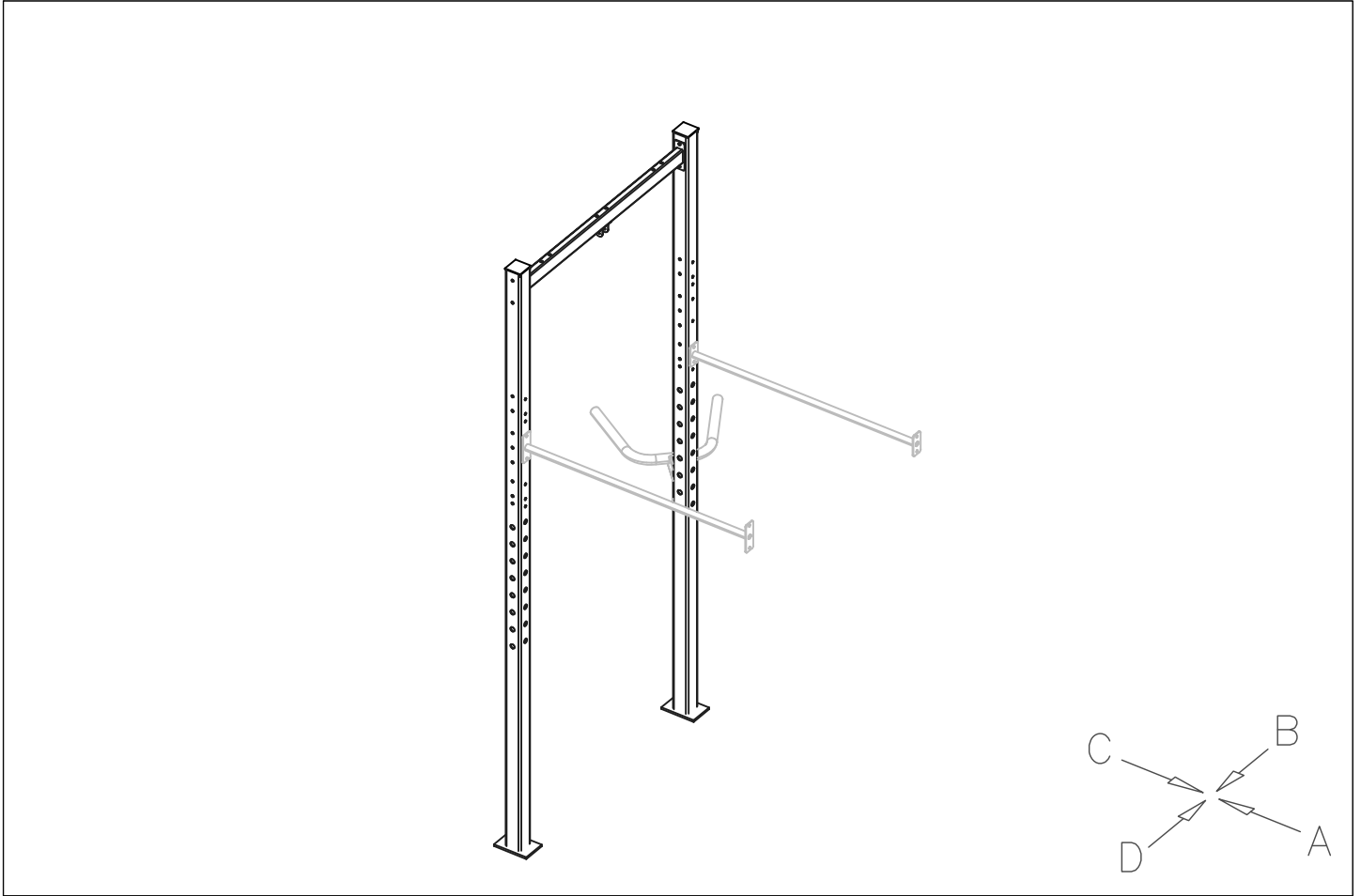

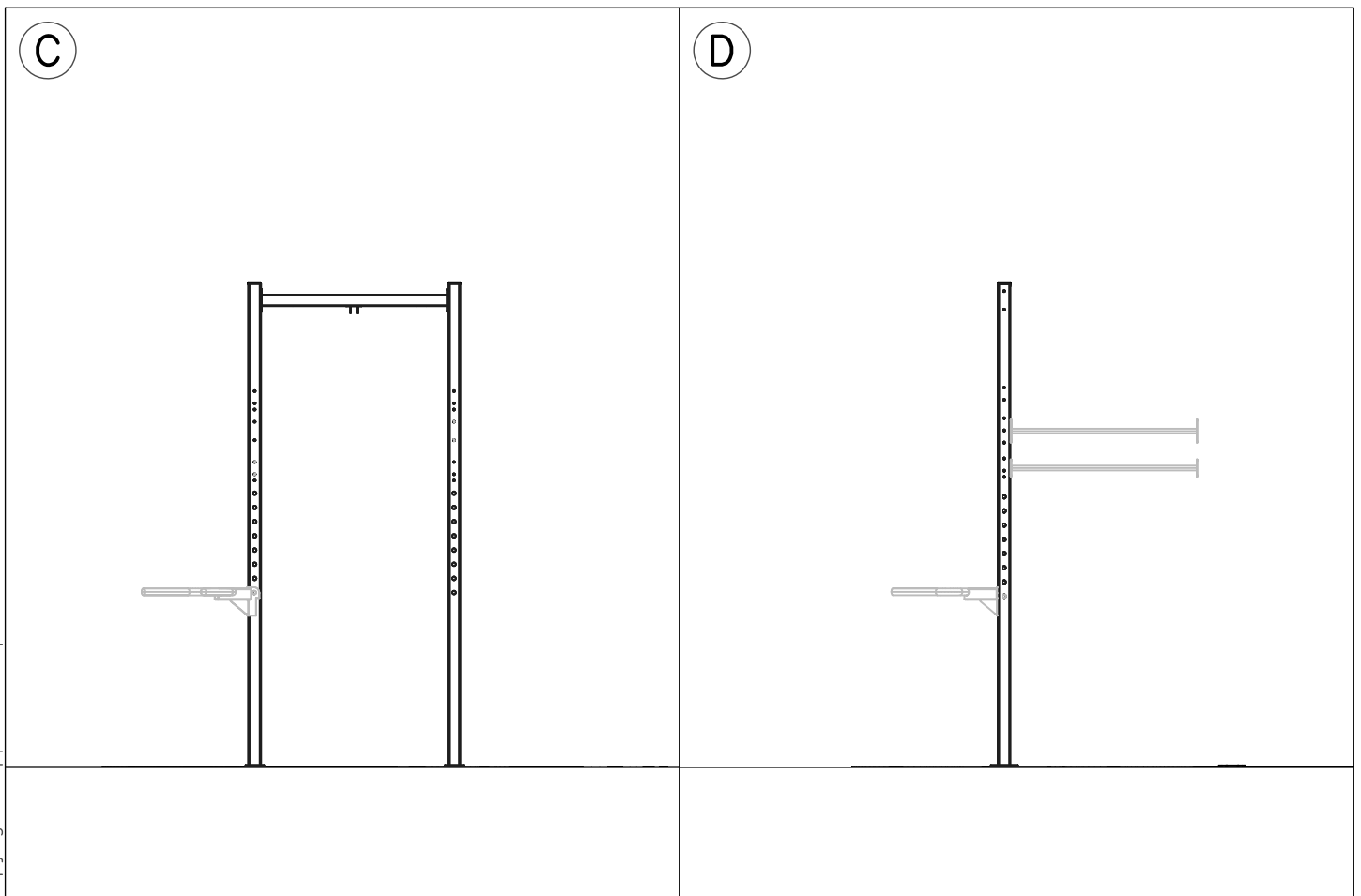
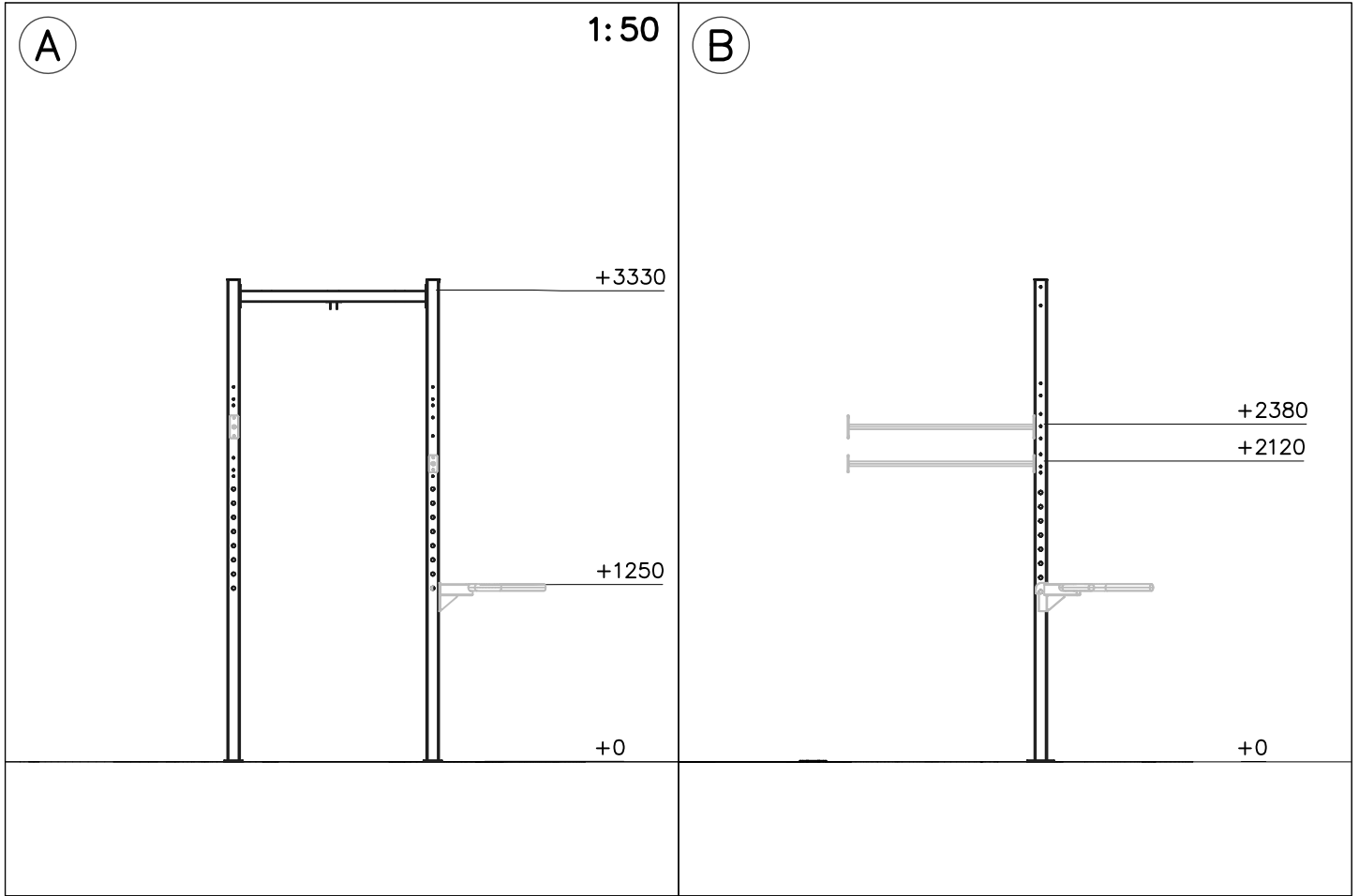

DATE: 14.9.2023

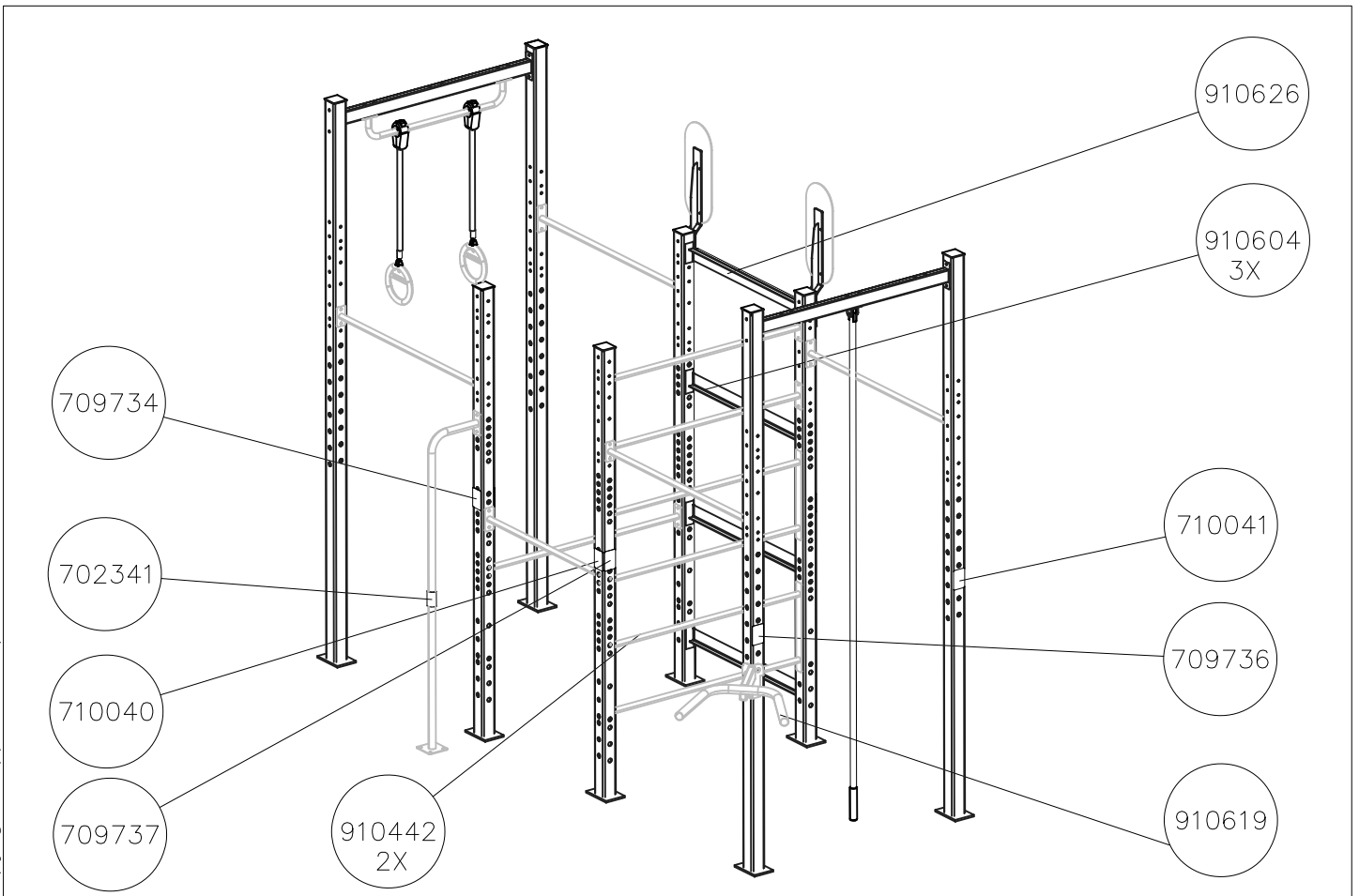
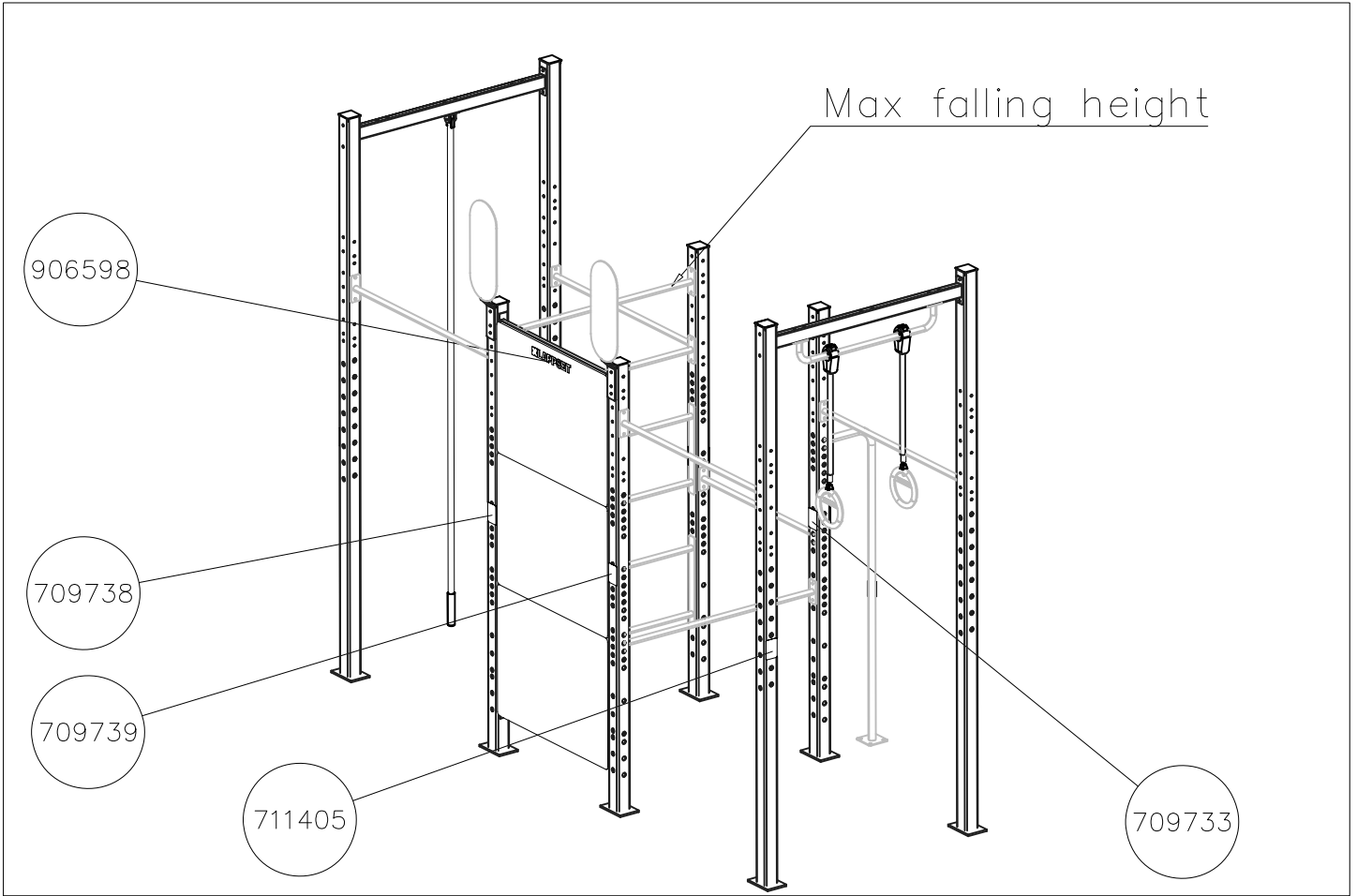

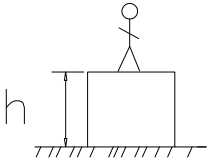

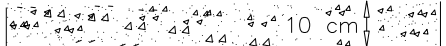
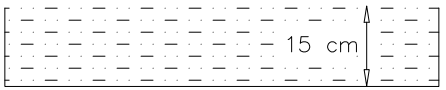
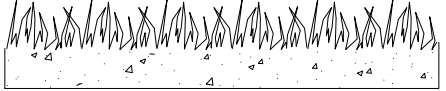
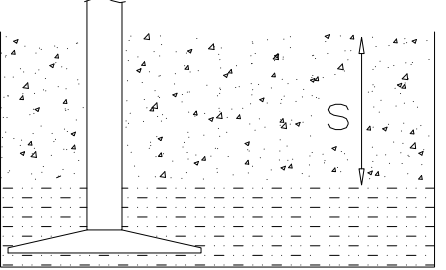
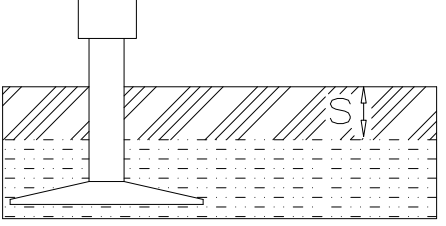
		
<p>h < 1000</p>	<p>Totally hard surfaces or materials with very limited impact attenuating properties.</p> <p>Case by case risk assessment is needed including e.g. evaluation whether there is forced movement, what is the intended exercise and where will the product be installed.</p>	<p>Totally hard surfaces. E.g. concrete or asphalt</p>  <p>Materials with very limited impact attenuating properties. E.g. wood</p> 
<p>h < 1200</p>	<p>Materials with significant impact attenuating properties.</p>	<p>fine gravel 0–8 mm</p>  <p>Unsorted sand/ topsoil</p> 
<p>h < 1500</p>	<p>Lawn</p> 	
<p>h < 3000</p>	<p>Loose fill material</p> <p>E.g. sand/gravel 0,25...8 mm D60/D10<3,0 Woodchips 5...30 mm bark 20...80 mm</p>	 <p><u>S</u> <u>h</u> 30 cm < 2,0 m 40 cm < 3,0 m</p>
<p>Syntetic granulates</p> <p><u>S</u> <u>h</u> 40 mm ~ > 1,2...1,3 m 50 mm ~ > 1,5...1,7 m 60 mm ~ > 1,8...2,0 m 70 mm ~ > 2,1...2,5 m</p> <p>Note. For accurate values, see manufacturer's instructions.</p>		

**Tuotekyltti tulee tuotteen mukana yhdellä seuraavista tavoista:****1) Metallinen tuotekyltti ja kiinnitysruuvit**

- Kiinnitä tuotekyltti ruuveilla tolppaan noin 2 metrin korkeuteen kuvan 1 mukaisesti.

2) Tuotekylttitarra

- Puhdista maalattu metalli- tai vaneripinta pölystä ja kosteudesta. Liimaa tarra kuvan 2 mukaisesti.
- Huom. Älä kiinnitä tarraa karheapintaiseen laminaattiin tai maalattuun puuhun.

Vår produktmärkning levereras på ett av följande sätt:**1) Produktskylt i metall**

- Fäst skylten med de medföljande skruvarna

2) Självhäftande produktetikett

- Rengör den pulverlackerade metallytan eller laminatyten så att den blir fri från smuts och fukt. Fäst etiketten enligt fig. 2.
- Obs! Fäst ej etiketten på detaljer med skrovlig yta eller på målat trä.

Product label is delivered by one of following ways:**1) Metal product label and screws**

- Fasten the label with screws.

2) Label sticker

- Clean the painted metal or plywood surface from dirt and moisture. Fasten the sticker as shown in the figure 2.
- Note. Do not attach the sticker to rough surfaced laminate or painted wood.

La plaque d'informations produit est livrée sous l'une de ces 3 formes :**1) Plaque métallique et vis**

- Fixez la plaque à l'aide des vis.

2) Etiquette autocollante



- Avant de coller l'étiquette, nettoyez le composant métallique peint ou la plaque de contreplaqué, de toute saleté. La surface doit être sèche (voir image 2).
- Attention, ne pas coller l'étiquette sur une surface lamellé-collée irrégulière ou sur du bois peint.

Die Auslieferung des Produktaufklebers erfolgt auf eine dieser Arten:**1) Produkt-Schild aus Metall incl. Schrauben**

- Die Befestigung des Schildes erfolgt mittels der Schrauben.

2) Aufkleber

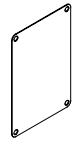
- Entfernen Sie zunächst Schmutz und Feuchtigkeit vom lackierten Metall bzw. von der Holzoberfläche und bringen Sie den Aufkleber wie im Bild oben rechts beschrieben auf den gesäuberten Untergrund auf.
- Beachten Sie: Bringen Sie den Aufkleber nicht auf raues laminiertes oder lackiertes Holz an.

①	SIGN	PCS	②	905390	PCS
		1			4
118x78			Ø4,8x28		

