

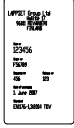









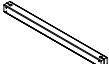

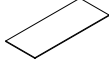

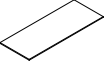

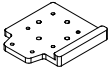

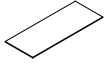
① 702341  90x50	PCS 1	② 707213  118x118x1490	PCS 4
③ 707517  118x118x1892	PCS 4	④ 708137  118x118x745	PCS 4
⑤ 708836  15x745x1736	PCS 2	⑥ 708837  15x745x2168	PCS 2
⑦ 708839  15x745x1897	PCS 1	⑧ 708840  15x148x2018	PCS 2
⑨ 708841  15x148x1616	PCS 2	⑩ 708857 JIG  20x133x149	PCS 1
⑪ 911288 COLOR  15x745x1465	PCS 2	⑫ 911289 COLOR  15x745x1897	PCS 1
⑬ 980123  Ø7x60	PCS 108	⑭ 900240  Ø8x70	PCS 64
⑮ 903093  Ø8x90	PCS 32	⑯ 905103  PT-28/32-H	PCS 16

⑰ 905112	PCS	⑱ 910266	PCS	PCS	PCS	PCS	PCS	PCS
	32		16					
		90x108x118						
Ø22								

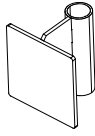
FOOT OPTIONS

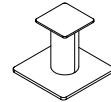
709261+		709262+	
○ 910330	PCS	○ 910567	PCS
SURFACE	4	CONCRETE	4
			
152x200x200		117x117x715	

----- Falling Space 22.7 m2
Max Falling Height 920 mm

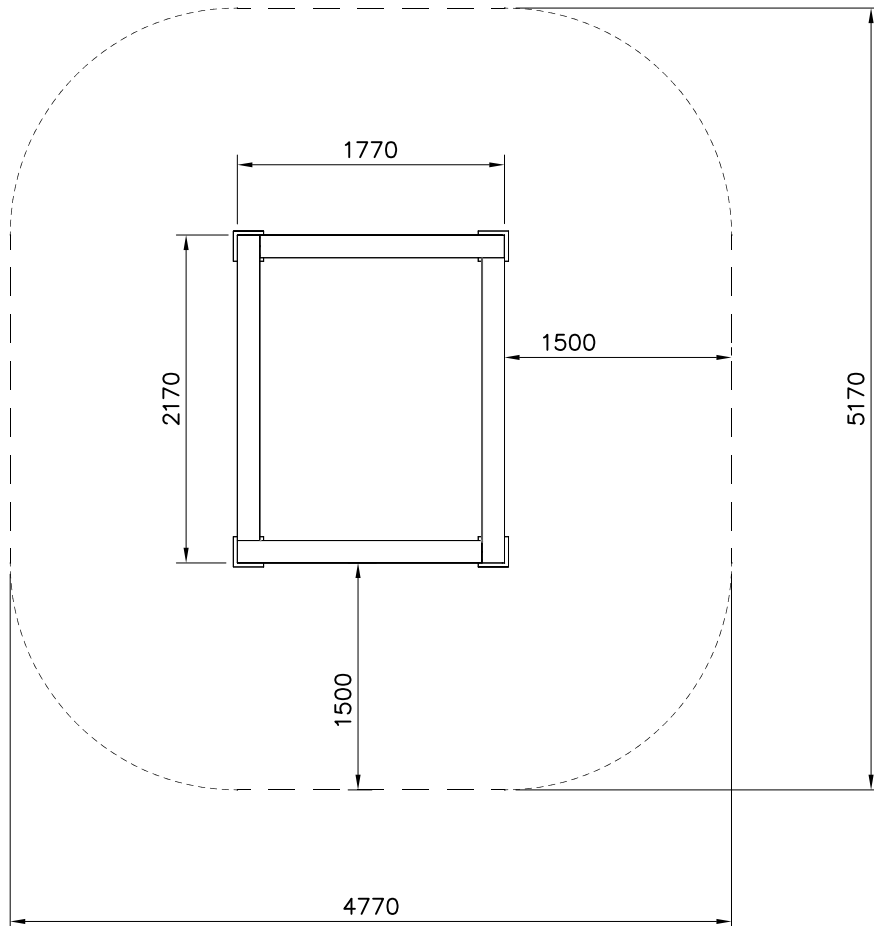
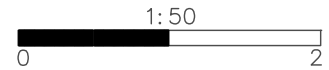

DET 1

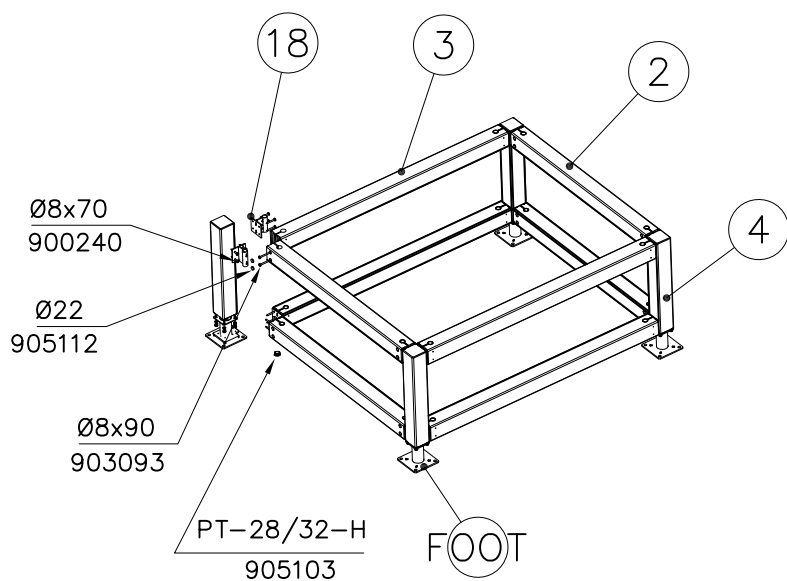

NOTE:
Use drill jig 708857
to predrill $\text{Ø}5\sqrt{50}$
holes for 910266

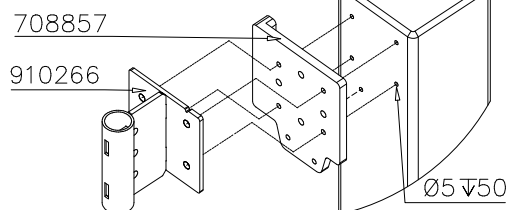

DET 2

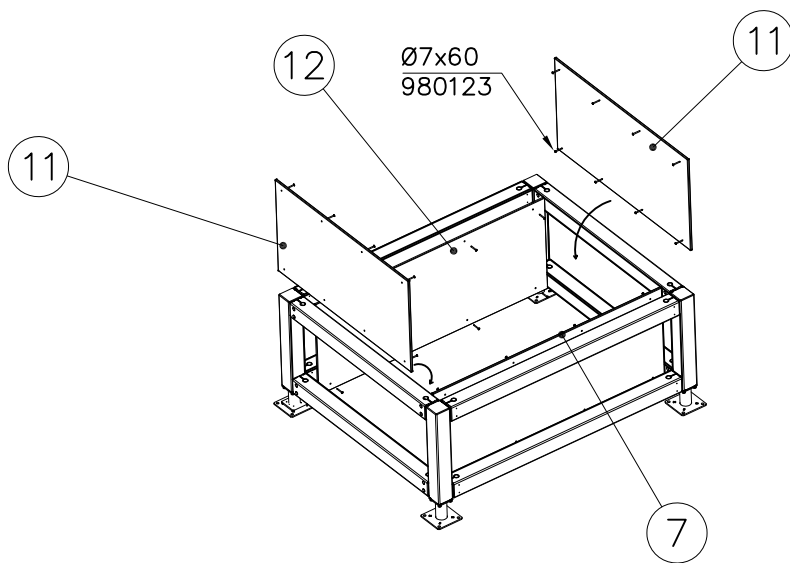

DET 3

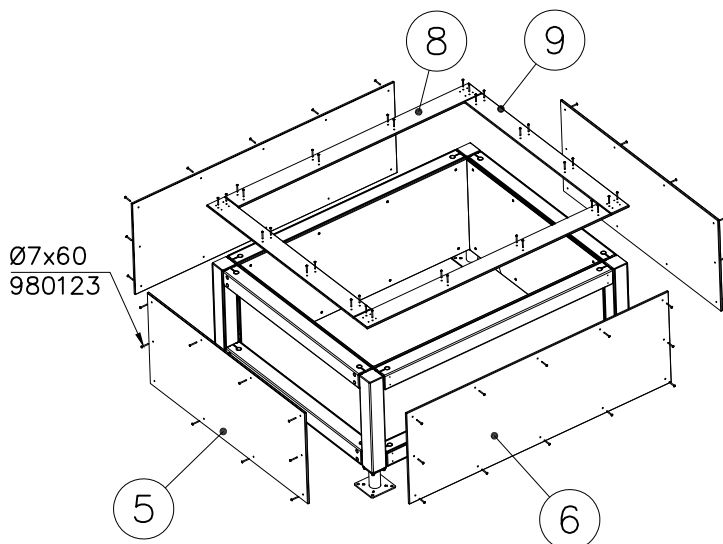

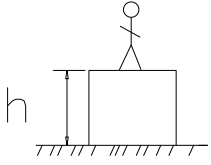

$h < 1600$

Totally hard surfaces or materials with very limited impact attenuating properties.

Case by case risk assessment is needed including e.g. evaluation whether there is forced movement, what is the intended exercise and where will the product be installed.

Materials with significant impact attenuating properties.

Totally hard surfaces.
E.g. concrete or asphalt



Materials with very limited impact attenuating properties.
E.g. wood



fine gravel 0–8 mm



Unsorted sand/ topsoil

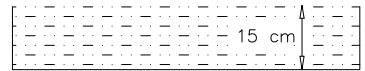

Lawn

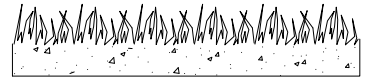

$h = 1600-$

$h < 3000$

Loose fill material

E.g.
sand/gravel 0,25...8 mm $D_{60}/D_{10} < 3,0$
Woodchips 5...30 mm
bark 20...80 mm

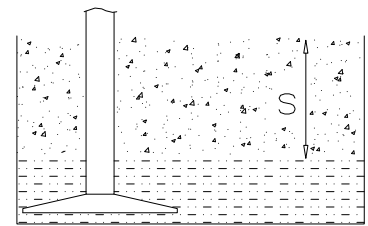

$\frac{S}{30 \text{ cm}}$ $\frac{h}{< 3,0 \text{ m}}$

Synthetic granulates

$\frac{S}{\text{mm}}$	$\frac{h}{\text{m}}$
40 mm	$\sim > 1,6... \sim < 1,8$ m
50 mm	$\sim > 1,8... \sim < 2,25$ m
55 mm	$\sim > 2,25... \sim < 2,4$ m
60 mm	$\sim > 2,4... \sim < 2,55$ m
70 mm	$\sim > 2,55... \sim < 3,0$ m

Note. For accurate values, see manufacturer's instructions.

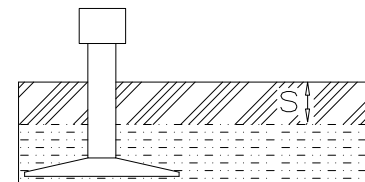



Tuotekyltti tulee tuotteen mukana yhdellä seuraavista tavoista:

1) Metallinen tuotekyltti ja kiinnitysruuvit

- Kiinnitä tuotekyltti ruuveilla tolppaan noin 2 metrin korkeuteen kuvan 1 mukaisesti.

2) Tuotekylttitarra

- Puhdista maalattu metalli- tai vaneripinta pölystä ja kosteudesta. Liimaa tarra kuvan 2 mukaisesti.
- Huom. Älä kiinnitä tarraa karheapintaiseen laminaattiin tai maalattuun puuhun.

Vår produktmärkning levereras på ett av följande sätt:

1) Produktskylt i metall

- Fäst skylten med de medföljande skruvarna

2) Självhäftande produktetikett

- Rengör den pulverlackerade metallytan eller laminatyten så att den blir fri från smuts och fukt. Fäst etiketten enligt fig. 2.
- Obs! Fäst ej etiketten på detaljer med skrovlig yta eller på målat trä.

Product label is delivered by one of following ways:

1) Metal product label and screws

- Fasten the label with screws.

2) Label sticker

- Clean the painted metal or plywood surface from dirt and moisture. Fasten the sticker as shown in the figure 2.
- Note. Do not attach the sticker to rough surfaced laminate or painted wood.

La plaque d'informations produit est livrée sous l'une de ces 3 formes :

1) Plaque métallique et vis

- Fixez la plaque à l'aide des vis.

2) Etiquette autocollante

- Avant de coller l'étiquette, nettoyez le composant métallique peint ou la plaque de contreplaqué, de toute saleté. La surface doit être sèche (voir image 2).
- Attention, ne pas coller l'étiquette sur une surface lamellé-collée irrégulière ou sur du bois peint.

Die Auslieferung des Produktaufklebers erfolgt auf eine dieser Arten:

1) Produkt-Schild aus Metall incl. Schrauben

- Die Befestigung des Schildes erfolgt mittels der Schrauben.

2) Aufkleber

- Entfernen Sie zunächst Schmutz und Feuchtigkeit vom lackierten Metall bzw. von der Holzoberfläche und bringen Sie den Aufkleber wie im Bild oben rechts beschrieben auf den gesäuberten Untergrund auf.
- Beachten Sie: Bringen Sie den Aufkleber nicht auf raues laminiertes oder lackiertes Holz an.

LAPPSET®

SURF. FOUNDATION

709261

DATE: 4.11.2021

1(1)

<p>h > 150</p> <p>120 Nm M16x170</p> <p>Concrete / Betoni K30</p>	<p>① 904450 PCS</p> <p>M16x170</p>	<p>② 905104 PCS</p> <p>M10</p>	
	<p>PCS</p>	<p>③ 905097 PCS</p> <p>M16</p>	<p>PCS</p>
	<p>PCS</p>	<p>PCS</p>	<p>PCS</p>
	<p>○ 910267 PCS</p> <p>152x200x200</p>	<p>○ 910330 PCS</p> <p>152x200x200</p>	
	<p>PCS</p>	<p>PCS</p>	<p>PCS</p>

Ø16 ↓ > 130

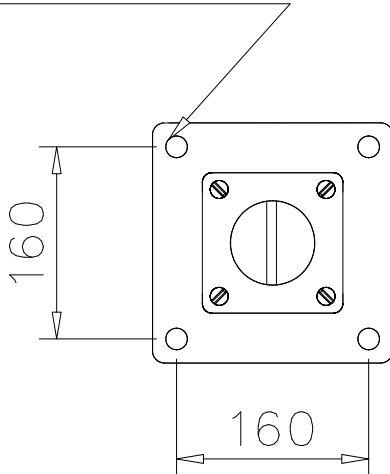

905097

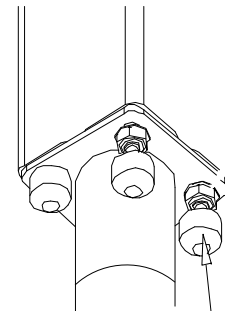
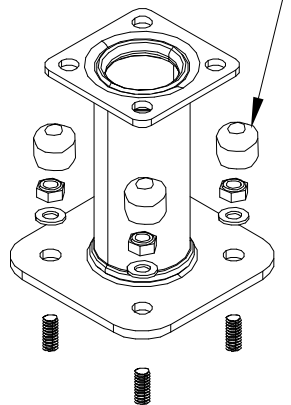

905104