

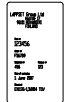

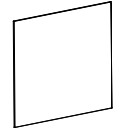

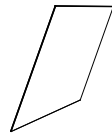

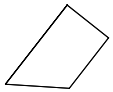



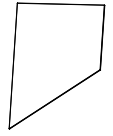







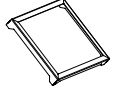



① 702341  90x50	PCS 1	② 709159  15x1200x1486	PCS 1
③ 709160  15x1486x2174	PCS 1	④ 709161  15x1170x2170	PCS 1
⑤ 709162  15x1376x1486	PCS 1	⑥ 709163  15x1170x1620	PCS 1
⑦ 709164  18x80x1135	PCS 2	⑧ 709165  18x80x1420	PCS 2
⑨ 902233  M10x30	PCS 24	⑩ 905112  Ø22	PCS 24
⑪ 909637  M10	PCS 24	⑫ 909638  Ø20/10.5	PCS 48
⑬ 909876  M8x40	PCS 48	⑭ 910744  154x1160x1445	PCS 1

⑮ 910768  30x60x1349	PCS 2	⑯ 910769  30x60x1504	PCS 2	⑰ 910793  L 2158	PCS 1	⑱ 910794  L 1425	PCS 1	⑲ 910795  L 1646	PCS 1	⑳ 910796  L 884	PCS 1
---	----------	---	----------	---	----------	--	----------	---	----------	--	----------

②1	980108	PCS	②2	980128	PCS	②3	980150	PCS	②4	980151	PCS	FOOT OPTION	
		4			12			48			48	709387+	
	Ø4x25			Ø7x40			M8			Ø16/8.4		○ 709386	PCS
												SURFACE	1
												○ 910567	PCS
												CONCRETE	4
													
												M16x170	
													
												117x117x715	



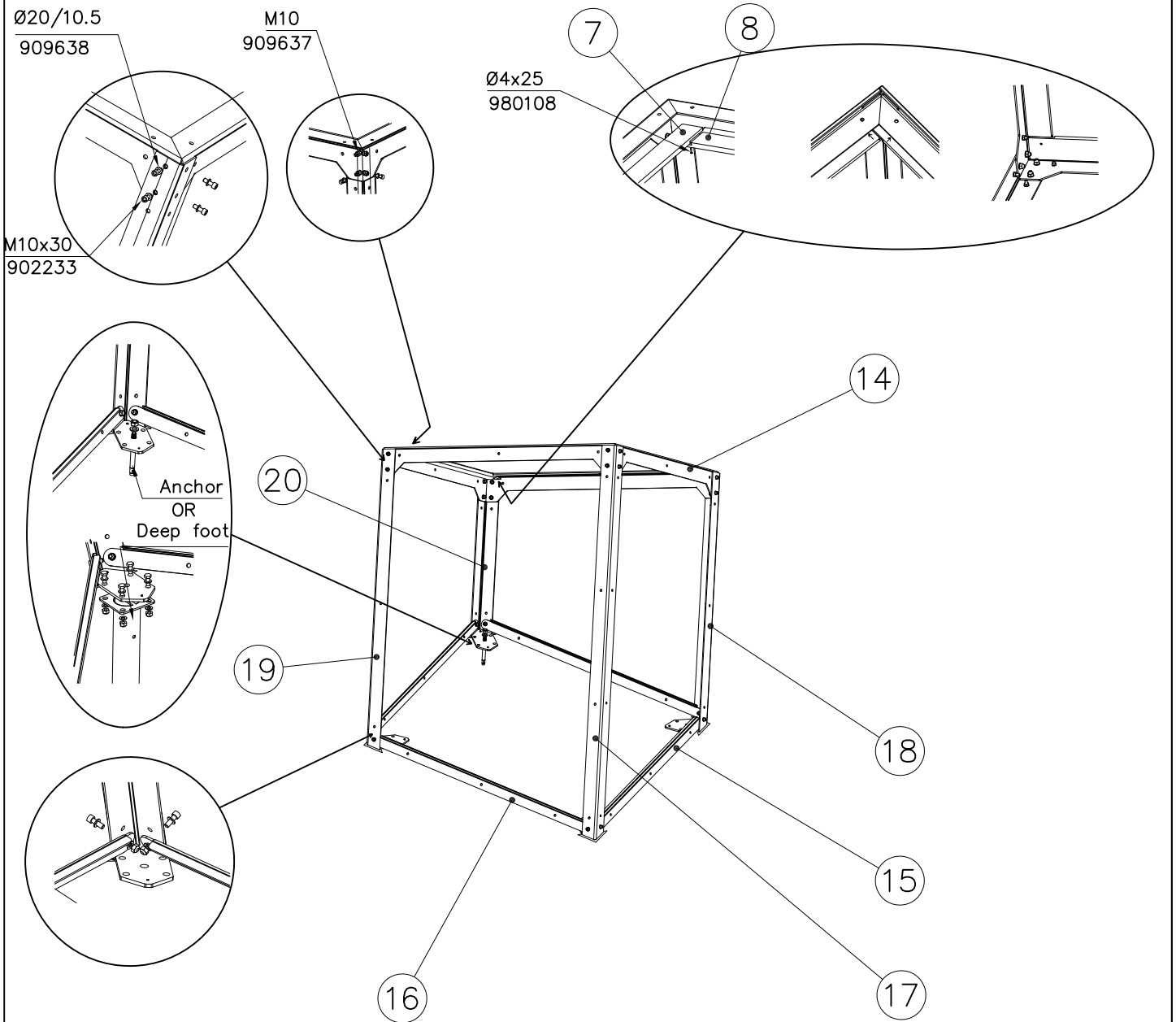
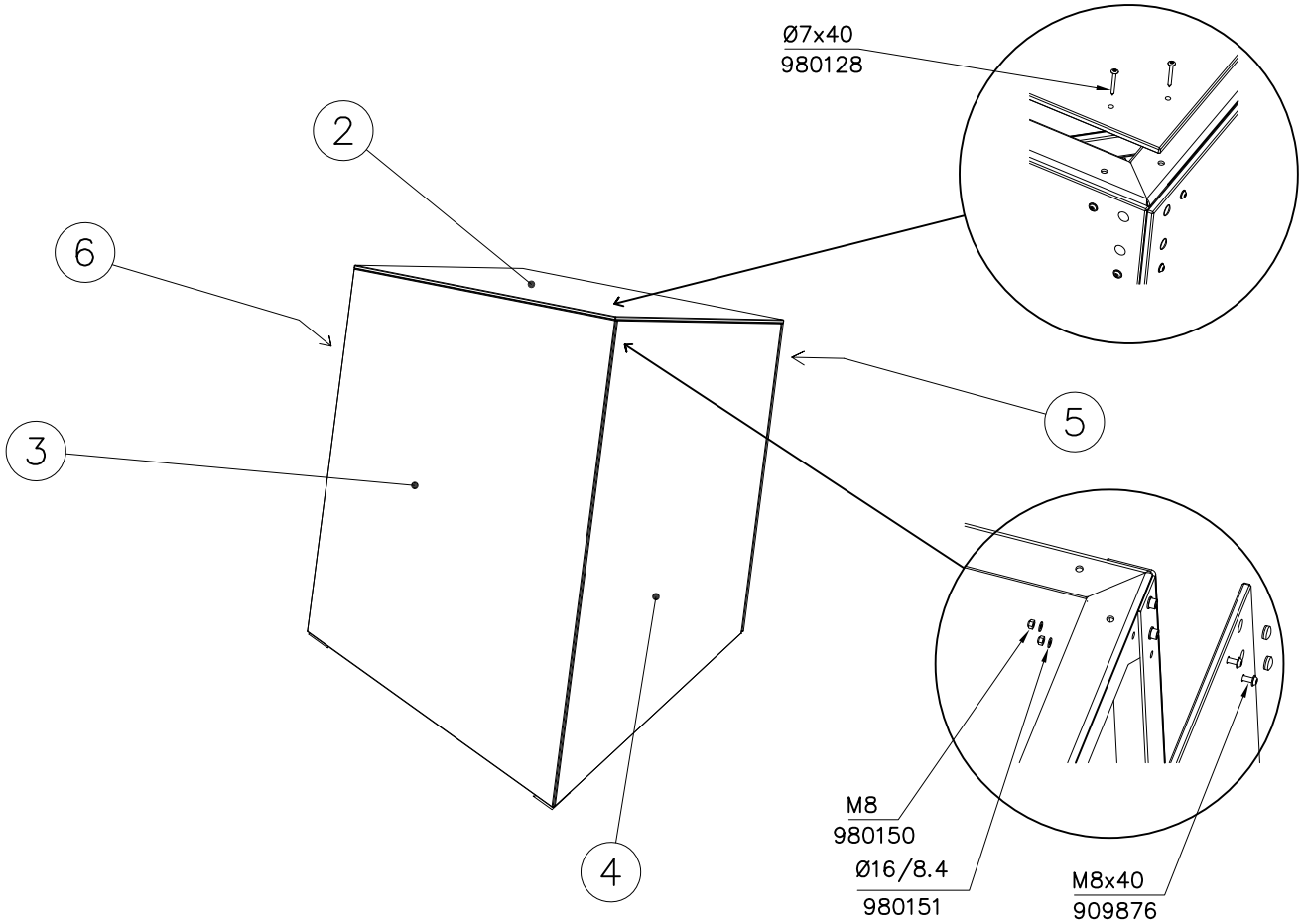

—— EN Impact Attenuating Surface (IAS) 24.4 m²

---- Falling Space 24.4 m²

Max Falling Height 1740 mm

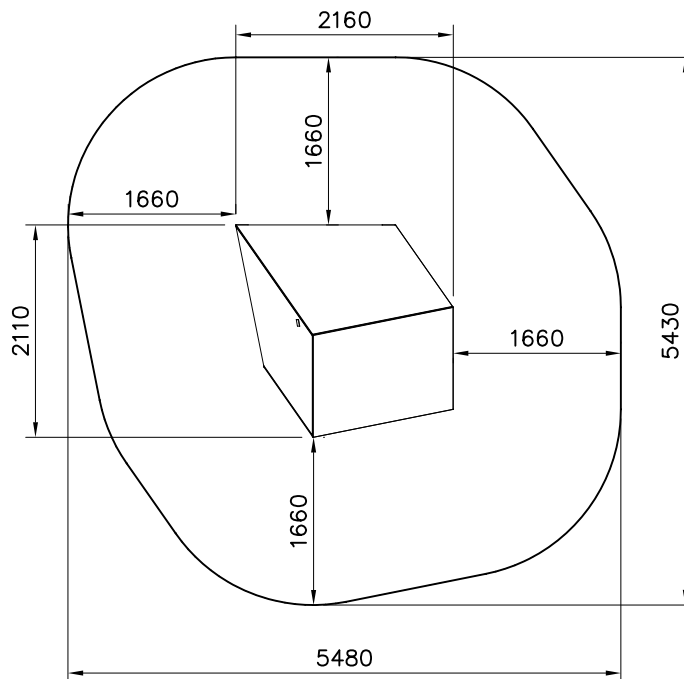
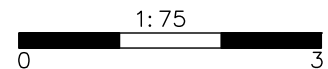

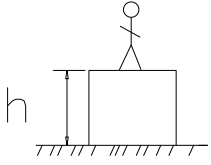

$h < 1600$

Totally hard surfaces or materials with very limited impact attenuating properties.

Case by case risk assessment is needed including e.g. evaluation whether there is forced movement, what is the intended exercise and where will the product be installed.

Materials with significant impact attenuating properties.

Totally hard surfaces.
E.g. concrete or asphalt



Materials with very limited impact attenuating properties.
E.g. wood



fine gravel 0–8 mm



Unsorted sand/ topsoil

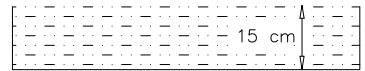

Lawn

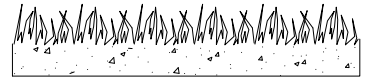

$h = 1600-$

$h < 3000$

Loose fill material

E.g.
sand/gravel 0,25...8 mm $D_{60}/D_{10} < 3,0$
Woodchips 5...30 mm
bark 20...80 mm

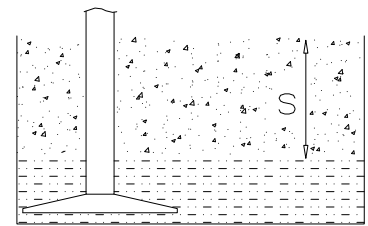

\underline{S}
30 cm \underline{h}
 < 3,0 m

Synthetic granulates

\underline{S}	\underline{h}
40 mm	~> 1,6...~< 1,8 m
50 mm	~> 1,8...~< 2,25 m
55 mm	~> 2,25...~< 2,4 m
60 mm	~> 2,4...~< 2,55 m
70 mm	~> 2,55...~< 3,0 m

Note. For accurate values, see manufacturer's instructions.

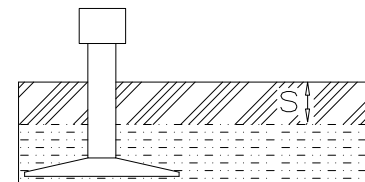

**Tuotekyltti tulee tuotteen mukana yhdellä seuraavista tavoista:****1) Metallinen tuotekyltti ja kiinnitysruuvit**

- Kiinnitä tuotekyltti ruuveilla tolppaan noin 2 metrin korkeuteen kuvan 1 mukaisesti.

2) Tuotekylttitarra

- Puhdista maalattu metalli- tai vaneripinta pölystä ja kosteudesta. Liimaa tarra kuvan 2 mukaisesti.
- Huom. Älä kiinnitä tarraa karheapintaiseen laminaattiin tai maalattuun puuhun.

Vår produktmärkning levereras på ett av följande sätt:**1) Produktskylt i metall**

- Fäst skylten med de medföljande skruvarna

2) Självhäftande produktetikett

- Rengör den pulverlackerade metallytan eller laminatyten så att den blir fri från smuts och fukt. Fäst etiketten enligt fig. 2.
- Obs! Fäst ej etiketten på detaljer med skrovlig yta eller på målat trä.

Product label is delivered by one of following ways:**1) Metal product label and screws**

- Fasten the label with screws.

2) Label sticker

- Clean the painted metal or plywood surface from dirt and moisture. Fasten the sticker as shown in the figure 2.
- Note. Do not attach the sticker to rough surfaced laminate or painted wood.

La plaque d'informations produit est livrée sous l'une de ces 3 formes :**1) Plaque métallique et vis**

- Fixez la plaque à l'aide des vis.

2) Etiquette autocollante

- Avant de coller l'étiquette, nettoyez le composant métallique peint ou la plaque de contreplaqué, de toute saleté. La surface doit être sèche (voir image 2).
- Attention, ne pas coller l'étiquette sur une surface lamellé-collée irrégulière ou sur du bois peint.

Die Auslieferung des Produktaufklebers erfolgt auf eine dieser Arten:**1) Produkt-Schild aus Metall incl. Schrauben**

- Die Befestigung des Schildes erfolgt mittels der Schrauben.

2) Aufkleber

- Entfernen Sie zunächst Schmutz und Feuchtigkeit vom lackierten Metall bzw. von der Holzoberfläche und bringen Sie den Aufkleber wie im Bild oben rechts beschrieben auf den gesäuberten Untergrund auf.
- Beachten Sie: Bringen Sie den Aufkleber nicht auf raues laminiertes oder lackiertes Holz an.

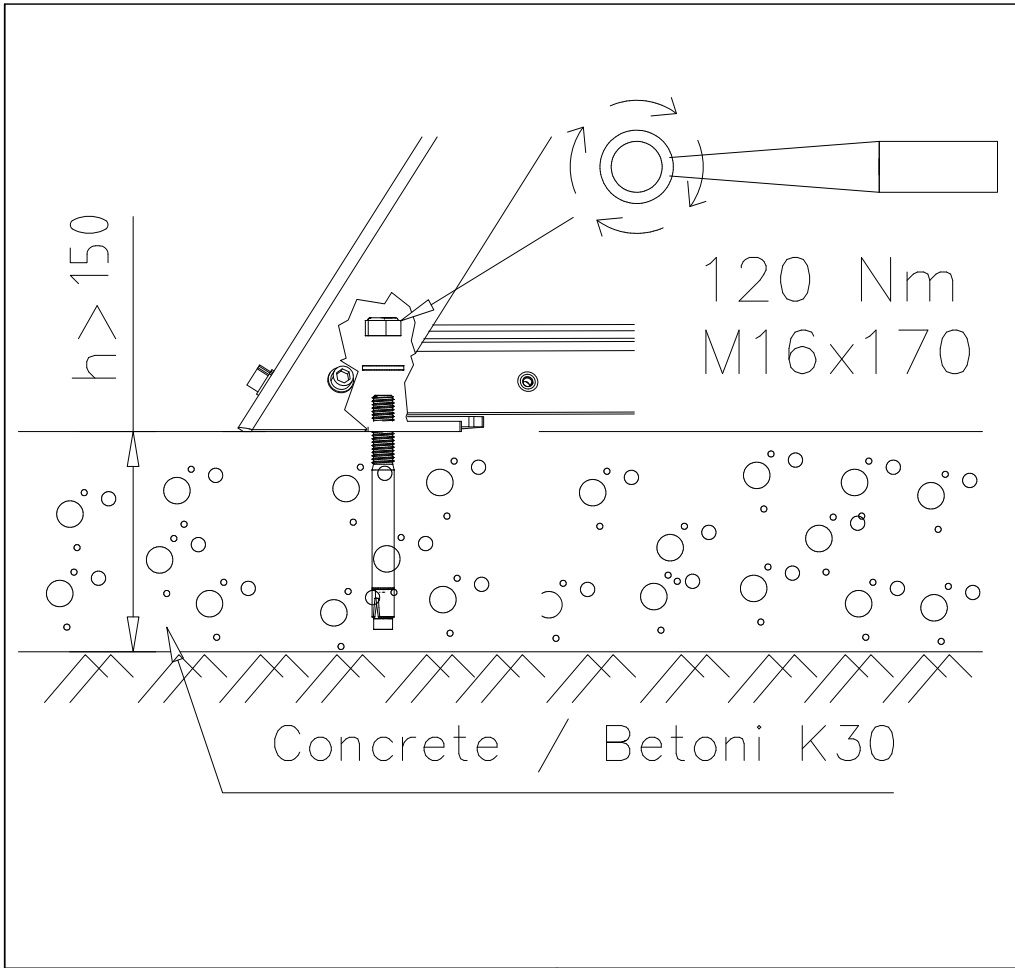

① 904450	PCS		PCS
	4		
M16x170			
	PCS		PCS
	PCS		PCS
	PCS		PCS

