

LAPPSET®

PROMENADE





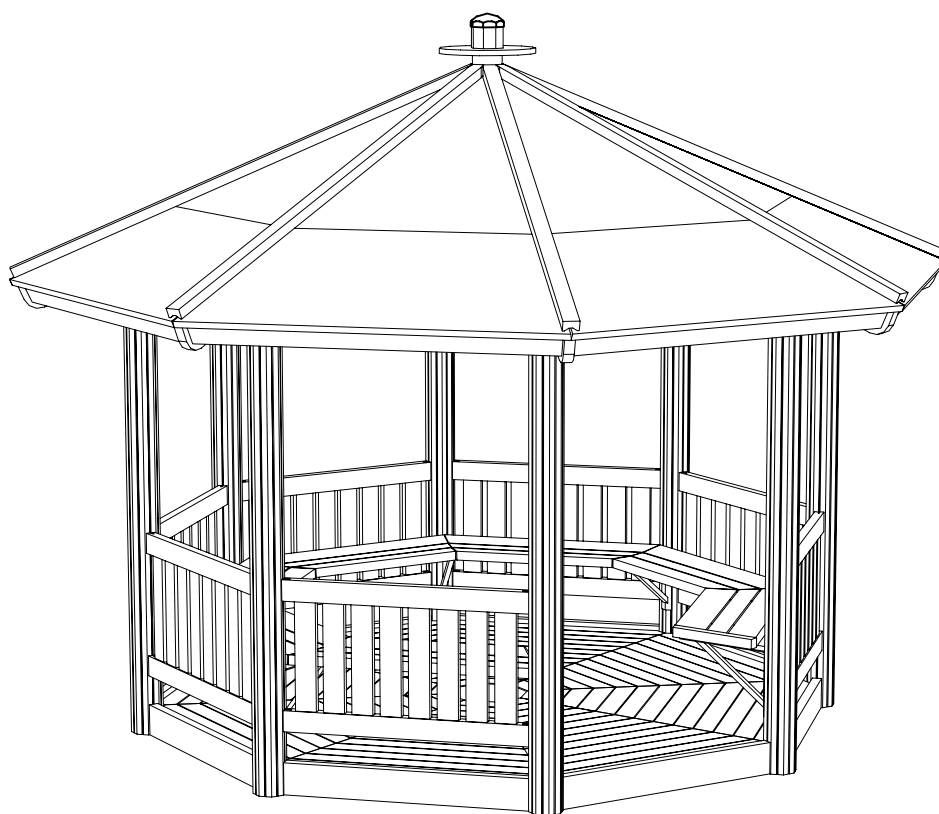

ASENNUSOHJE
MONTERINGSANSVISNING
INSTALLATION INSTRUCTION
AUFBAUANLEITUNG
NOTICE D'INSTALLATION

REF: 070206

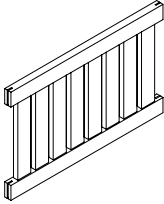
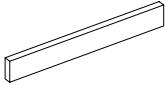
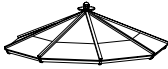
DATE: 10.10.2008

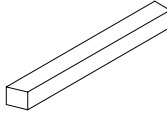
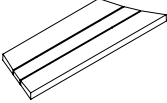
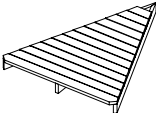
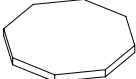
070206

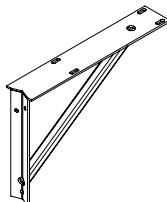
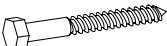
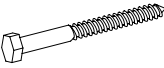
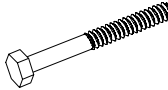

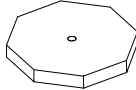
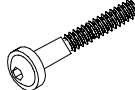
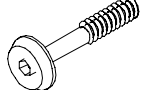
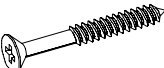
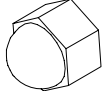
003779  PCS 7	702349  PCS 16 L1104	007165  PCS 1	007303  PCS 8 L 2240	007318  PCS 2	007342  PCS 7
007490  PCS 8	007491  PCS 1	905051  PCS 64 Ø24/8.4	980151  PCS 72 Ø16/8.4	907092  PCS 8	909217  PCS 24 8x70
909238  PCS 64 8x90	909287  PCS 8 M8x80	980150  PCS 8 M8	909667  PCS 9 300x300	909866  PCS 4 M8x60	909868  PCS 28 M8x50
980100  PCS 8 5x60	909633  PCS 32 M8 A2				

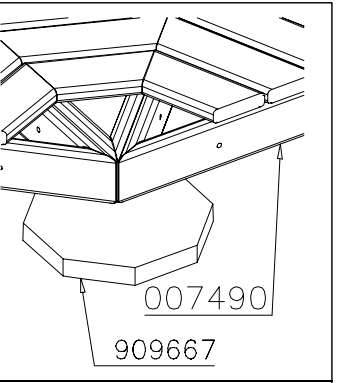
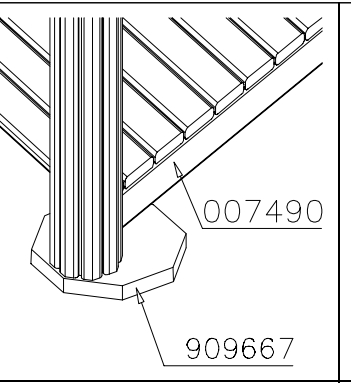
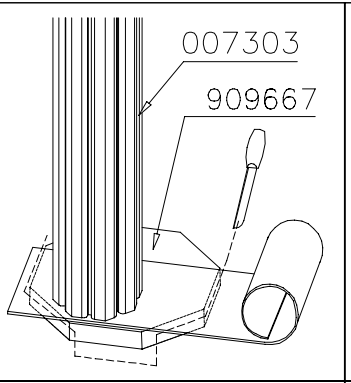
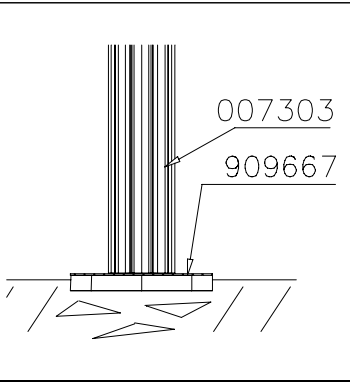
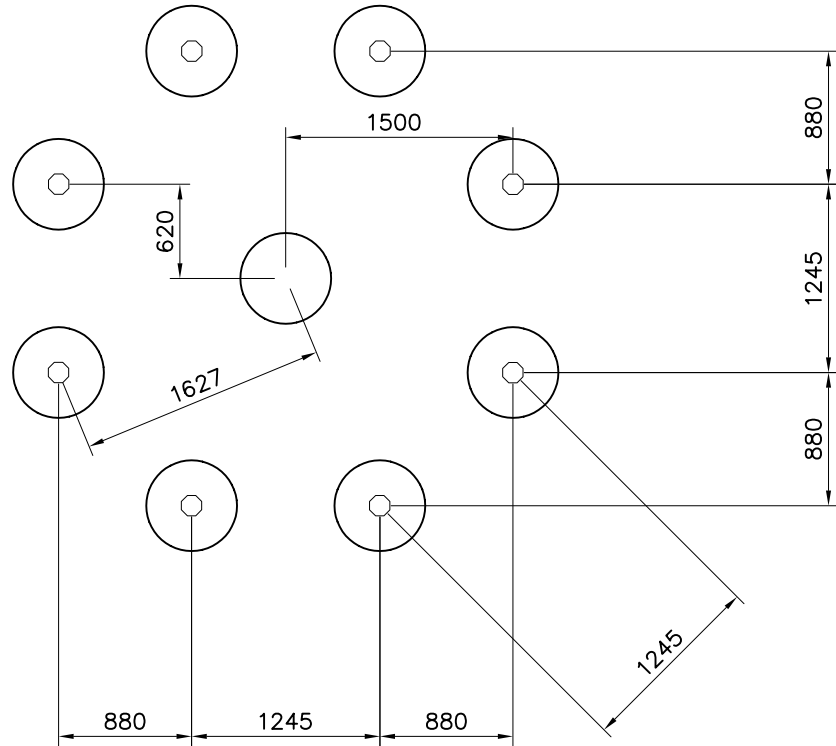
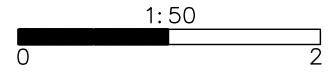

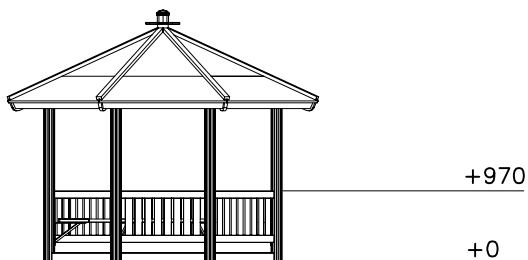
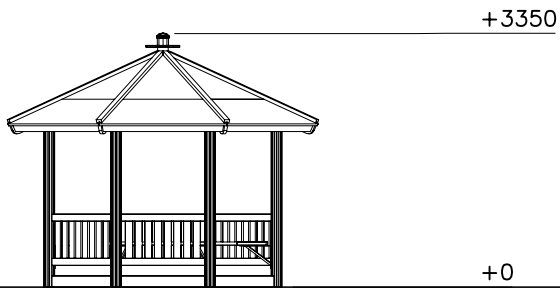
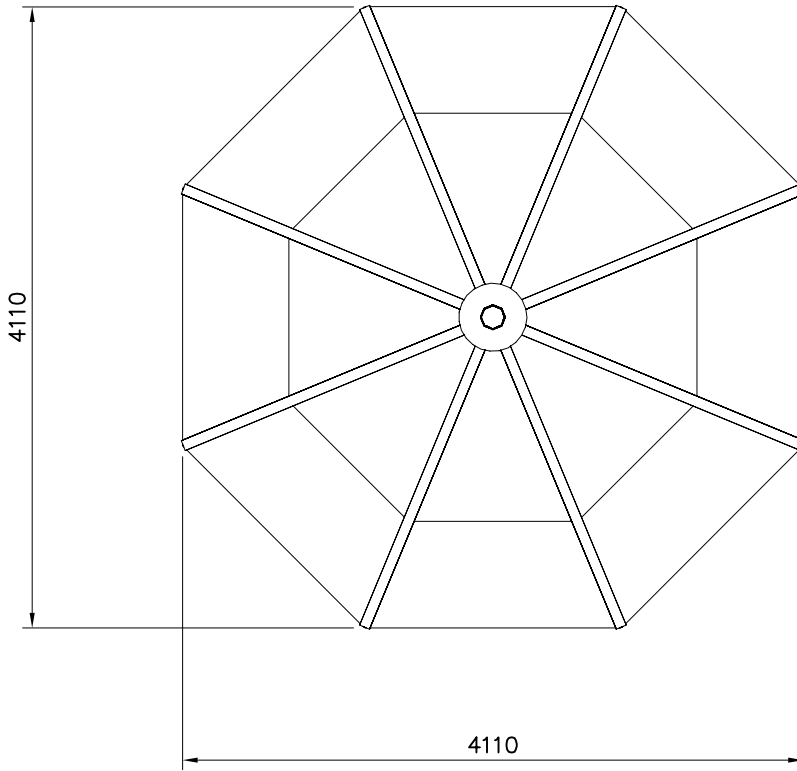
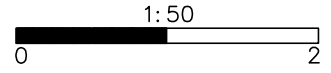

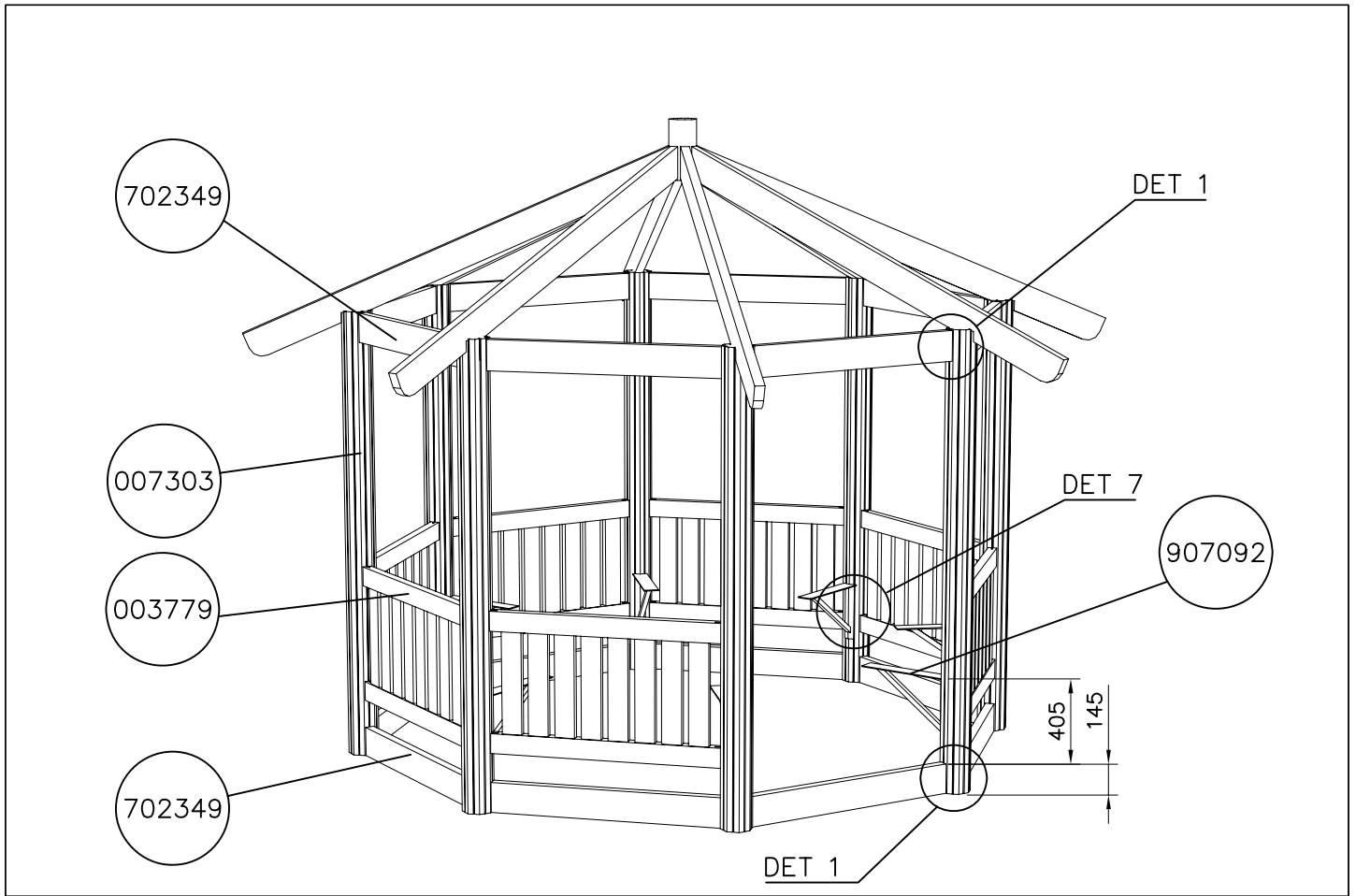

<p>DET 1</p>	<p>DET 2</p>	<p>DET 3</p>	<p>DET 4</p>
<p>DET 5</p>	<p>DET 6</p>	<p>DET 7</p>	

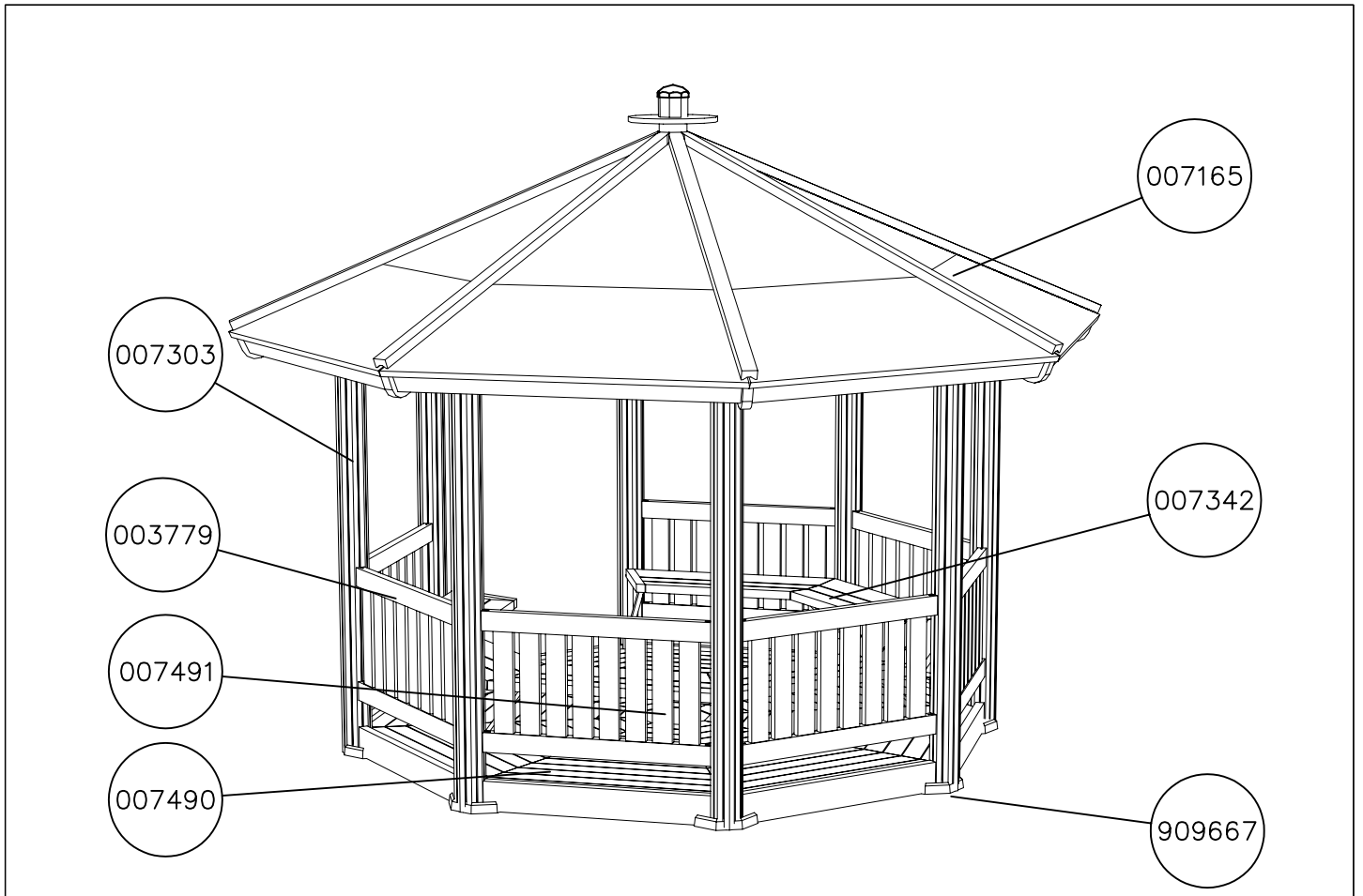
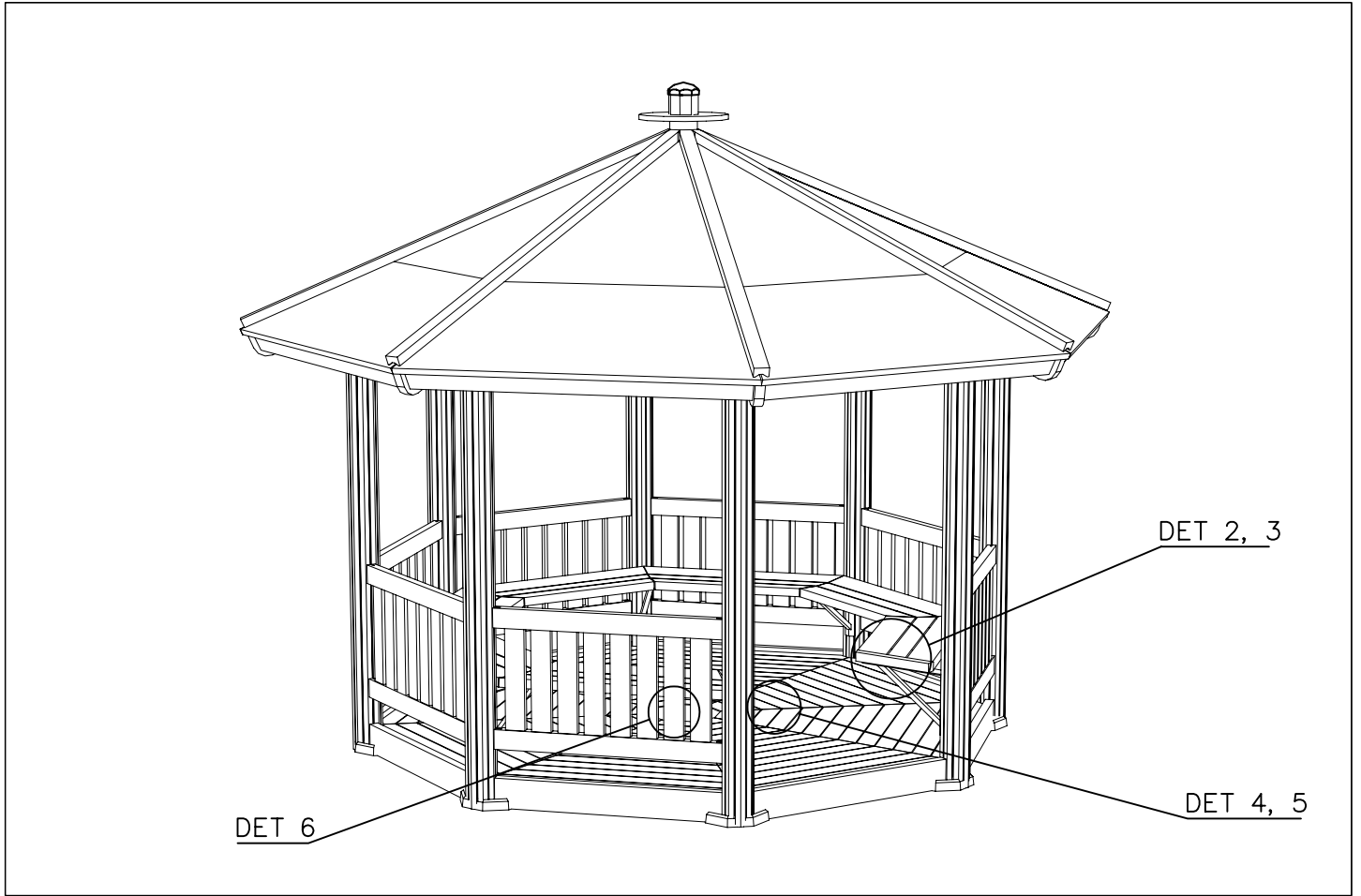

1. Tarkista pakkauslistan avulla, että olet saanut tarvitsemasi osat (s. 3).

2. Valitse huvimajalle paikka.

*Tasoita alue. Mittaa perustuslaattojen (909667) paikat (s. 4). Jos pystytät huvimajan asfaltille tai betonilaatalle, et tarvitse perustuslaattoja.

3. Aloita pystytys kiinnittämällä tolpat (7303) toisiinsa puomeilla 702349 (s. 6, det 1). Tarkista, että teline on suorassa.

4. Aseta lattiaelementit huvimajan sisään ja kiinnitä ne toisiinsa (s. 6, det 2-6).

5. Asenna katto (007163, 007165) erillisen ohjeen mukaan.

6. Kiinnitä istuinkannattimet ja istuimet (s. 6, det 7-9).

7. Kiinnitä seinäelementit 3781 erillisen ohjeen mukaan.

1. Kolla med hjälp av följesedeln att du erhållit önskade komponenter (sid. 3).

2. Välj lämplig plats för paviljongen och plangör ytan. Mät ut och markera platsen (sid. 4) för golvelementen (909667).

3. Börja monteringen med att fästa stolparna (7303) till varandra med hjälp av bommarna 702349 (sid. 6, det 1).

4. Lägg in golvelementen och fäst dem vid varandra (sid. 6, det 2-6).

5. Montera taket (007163, 007165) enligt separat anvisning.

6. Montera sitsbärarna och sitsarna (sid. 6, det 7-9).

7. Montera väggelementen enligt separat anvisning.

1. Use the packing list to check that none of the required components are missing (p. 3).

2. Select the location for the pavilion.

*Level the ground. Measure the position (p. 4) for the base plates (909667).

3. Start the assembly work by connecting the posts (7303) to each other, using the 702349 beams (p. 6, det 1).

4. Install the floor elements inside the pavilion and fasten them to each other (p. 6, det 2-6).

5. Install the (007163, 007165) roof in accordance with instructions separately provided.

6. Secure the seat brackets and seats (p. 6, det 7-9).







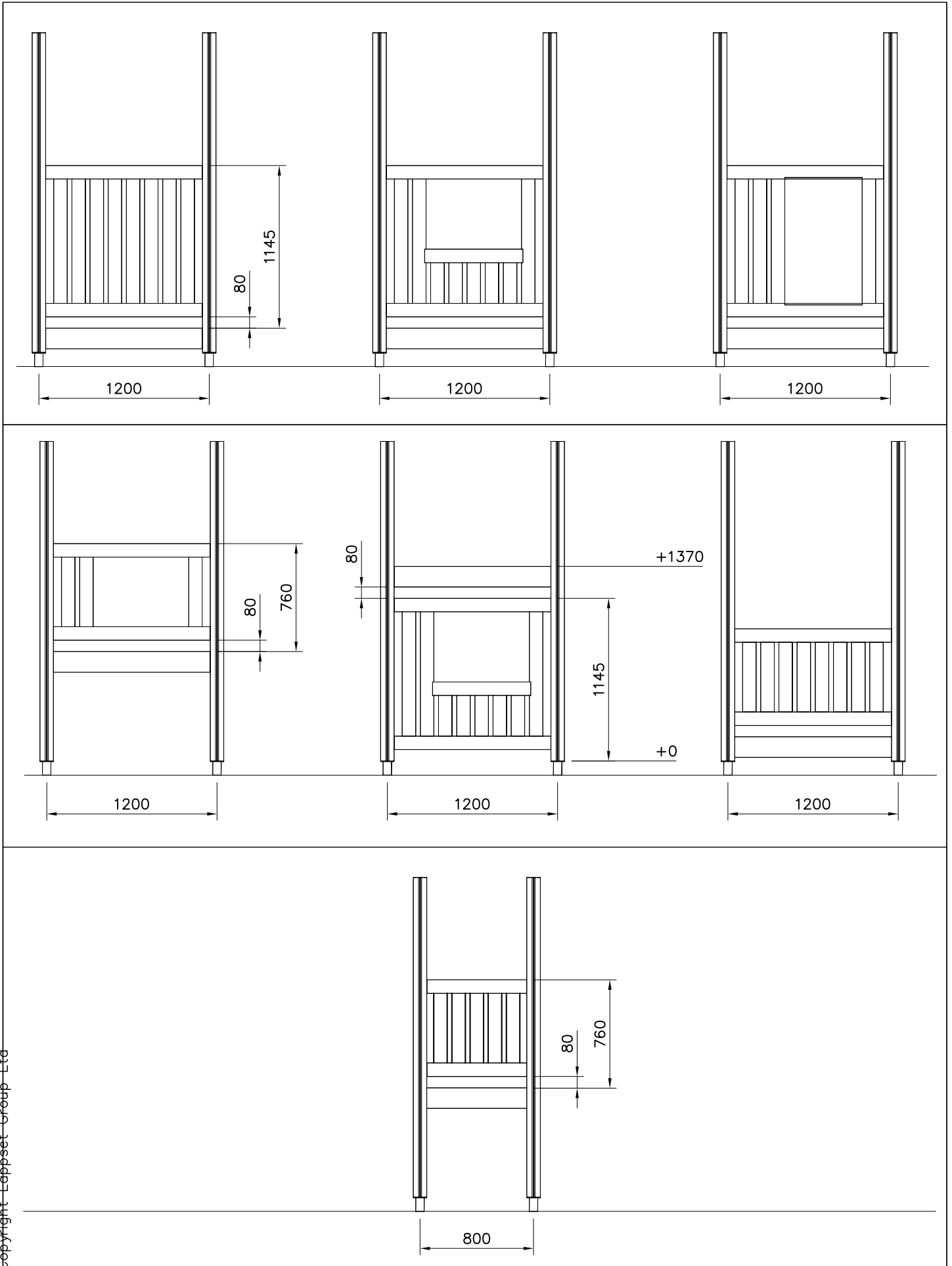

7. Secure the wall elements in accordance with instructions separately provided.

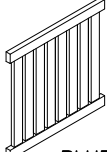
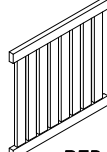
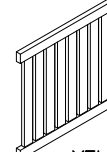
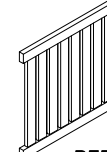
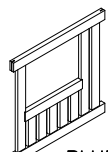
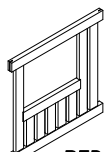
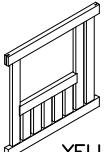
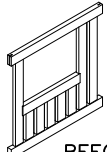
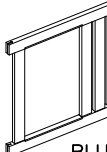
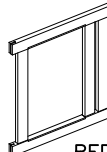
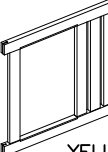
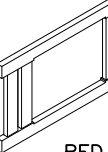
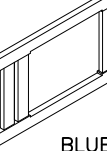
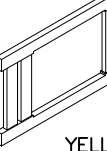
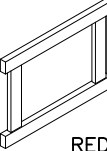
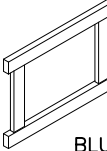
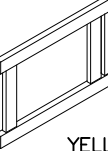
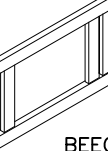
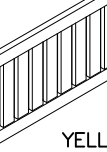
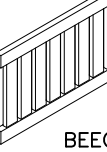
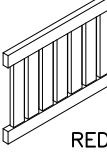
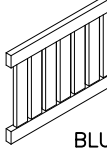
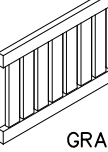
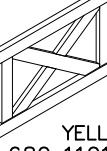
1. Prüfen Sie anhand der Packungsliste die Vollständigkeit der Lieferung (Seite 3)
2. Wählen Sie für den Pavillion einen geeigneten Standort aus. *Planieren Sie den Untergrund. Messen Sie die Stelle der Basisplatten aus (Seite 4). Wenn Sie den Pavillion auf Asphalt oder Betonplatten aufstellen, braucht es keine Basisplatten.
3. Zuerst werden die Pfosten (007303) mit den Balken (702349) befestigt (Seite 6, det 1).
4. Die Bodenlemente werden in den Pavillion ausgelegt, und miteinander befestigt. (Seite 6, det 2-7).
5. Montieren Sie das Dach (007163, 007165) anhand spezieller Montageanleitung.
6. Befestigen Sie die Sitzträger und die Sitze (Seite 6, det 8-10).
7. Befestigen Sie die Wandelemente 3779 anhand spezieller Montageanleitung.

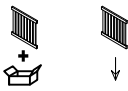
1. Vérifier, à l'aide de la notice jointe dans l'emballage, que l'on a reçu toutes les pièces nécessaires (p. 3).
2. Choisir l'emplacement de l'équipement à installer.
*Égaliser la surface. Mesurer les emplacements (p. 4) des bases de poteaux (909667).
3. Commencer le montage par l'assemblage des poteaux (007303) les uns aux autres, à l'aide des poutres 702349 (p.6, det 1)
4. Installer les planchers du kiosque en les fixant les uns aux autres (p. 6, det 2-7).
5. Installer le toit (007163, 007165) comme indiqué dans la notice.
6. Fixer les supports de banquettes et les banquettes (p. 6, det 8-10).
7. Fixer les parois comme indiqué dans la notice.

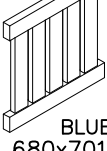
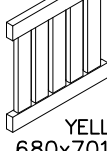
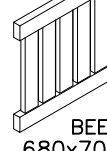
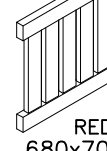
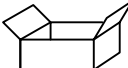
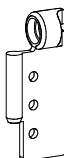
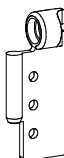



M 120	 BLUE 1065x1101	PCS 1	 RED 1065x1101	PCS 1	 YELL 1065x1101	PCS 1	 BEECH 1065x1101	PCS 1	 BLUE 1065x1101	PCS 1	 RED 1065x1101	PCS 1
	 YELL 1065x1101	PCS 1	 BEECH 1065x1101	PCS 1	 BLUE 1065x1101	PCS 1	 RED 1065x1101	PCS 1	 YELL 1065x1101	PCS 1	 RED 680x1101	PCS 1
	 BLUE 680x1101	PCS 1	 YELL 680x1101	PCS 1	 RED 680x1101	PCS 1	 BLUE 680x1101	PCS 1	 YELL 680x1101	PCS 1	 BEECH 680x1101	PCS 1
	 YELL 680x1101	PCS 1	 BEECH 680x1101	PCS 1	 RED 680x1101	PCS 1	 BLUE 680x1101	PCS 1	 GRAY 680x1101	PCS 1		PCS
	 YELL 680x1101	PCS 1	 GRAY 680x1101	PCS 1		PCS		PCS	 <p>003701 (003651) 701795 (701308) 008001 (003666)</p> <p>003700 (003650) 701618 (701309) 701619 (701310) 008000 (003665)</p>			
	 BLUE 680x701	PCS 1	 YELL 680x701	PCS 1	 BEECH 680x701	PCS 1	 RED 680x701	PCS 1	 <p>003702 (003652) 701796 (701305) 701797 (701306)</p> <p>003785 (003656) 701798 (701314) 701799 (701315)</p>			
	PCS		PCS		PCS		PCS	 <p>003798 (003660) 701800 (701312) 701801 (701313) 007998 (003663)</p>				
	PCS	 ① 909530	PCS 4	 ② 909217	PCS 4	 ③ 980151	PCS 4	 ④ 905112	PCS 4	 ⑤ 905120	PCS 4	
				8x70		Ø16/8.4		Ø22		Ø14		

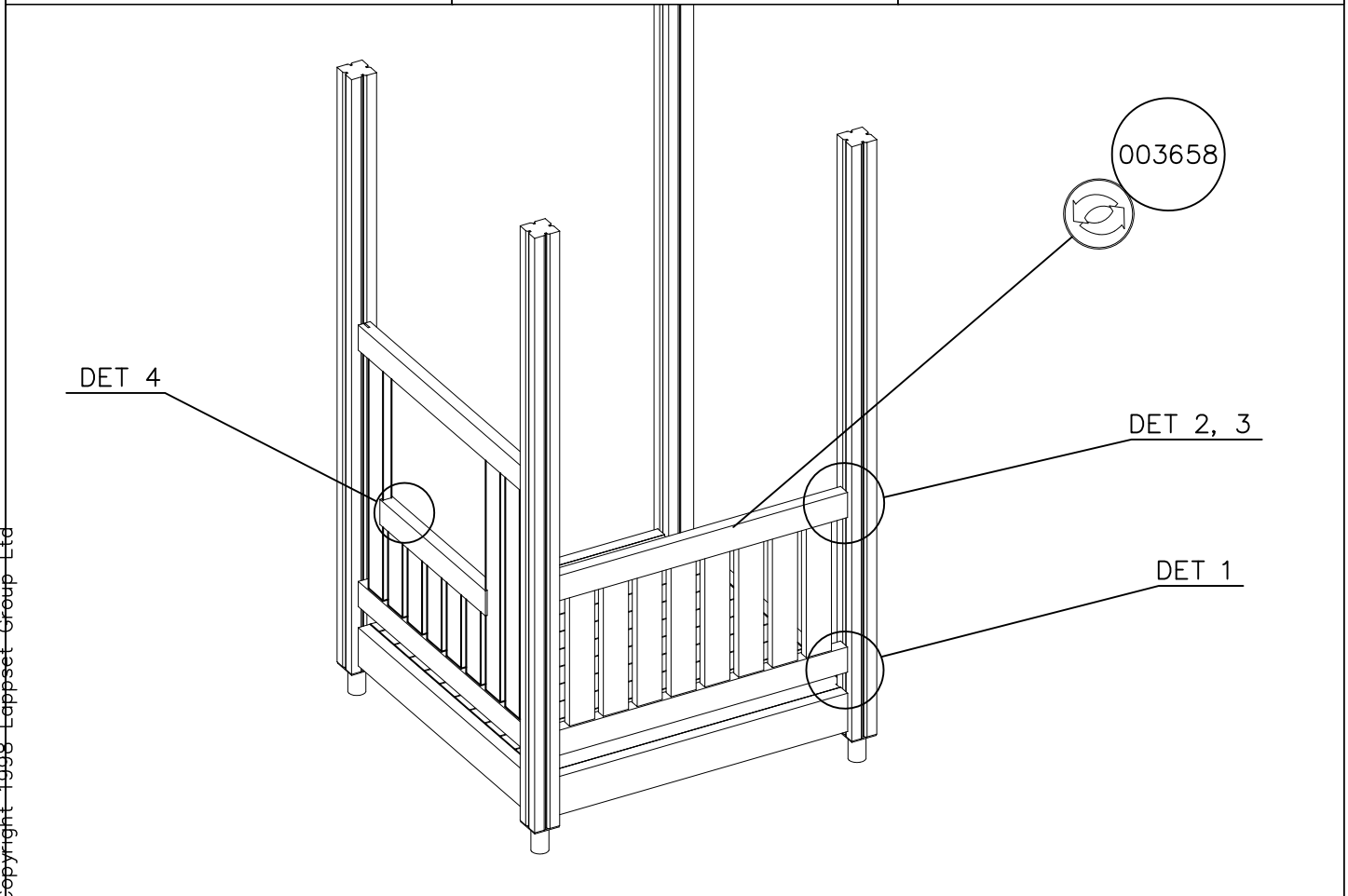
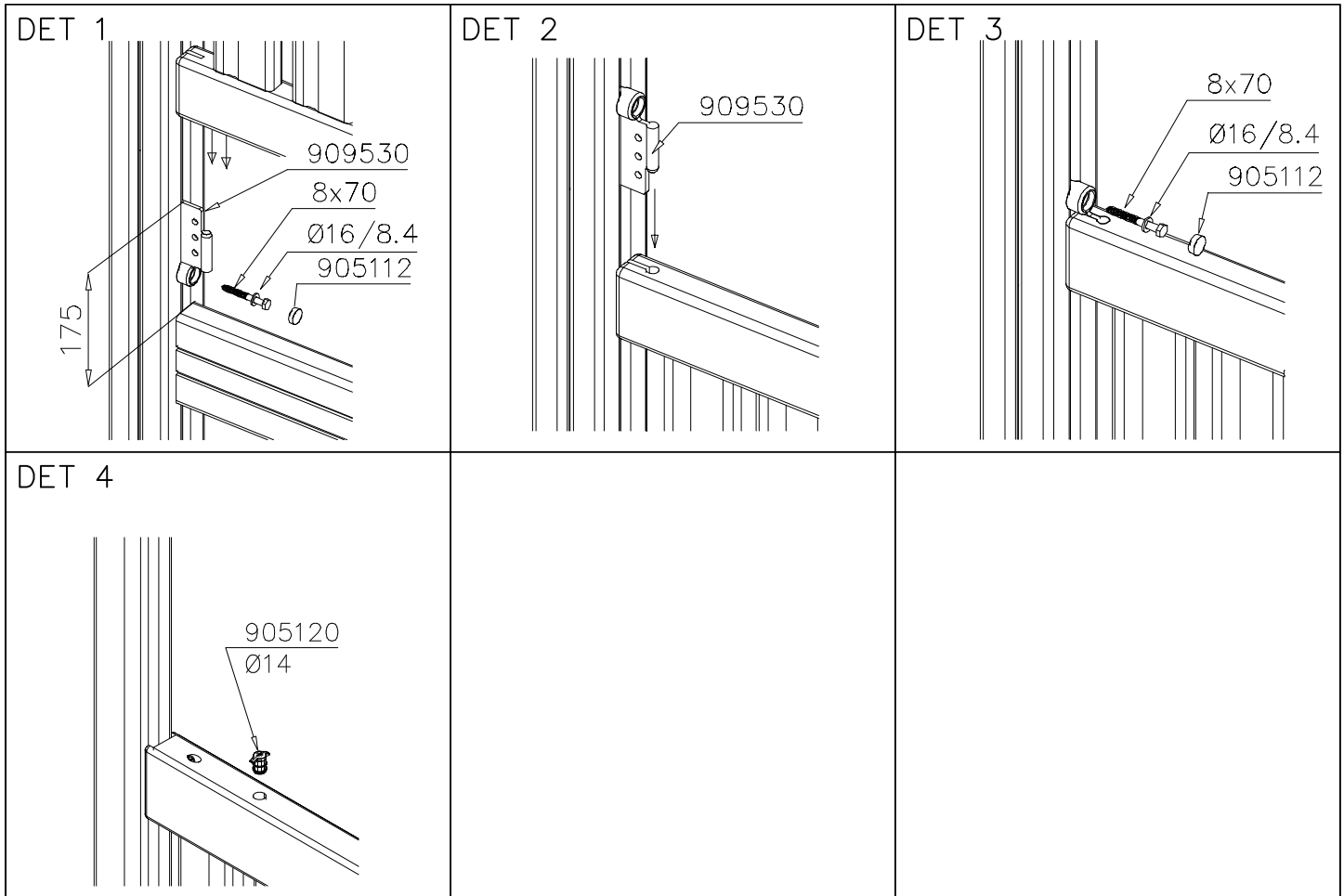

LAPPSET® PROMENADE

007165

DATE: 4.9.2024

1(2)

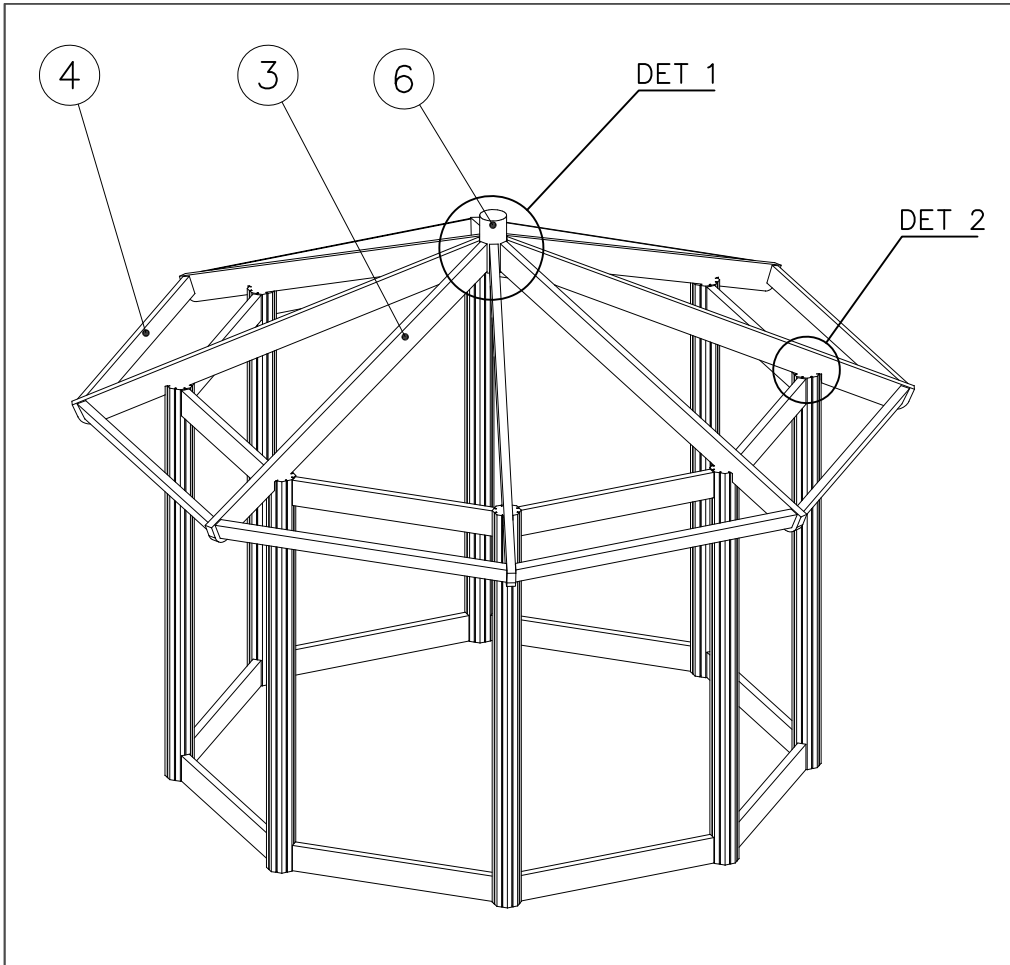

① 007493	PCS	② 007492	PCS
	8		8
③ 007495	PCS	④ 007498	PCS
	8		8
L 2297		L 1610	
⑤ 007496	PCS	⑥ 909666	PCS
	8		1
L 2330			
⑦ 007499	PCS	⑧ 905139	PCS
	1		1
		BLACK	

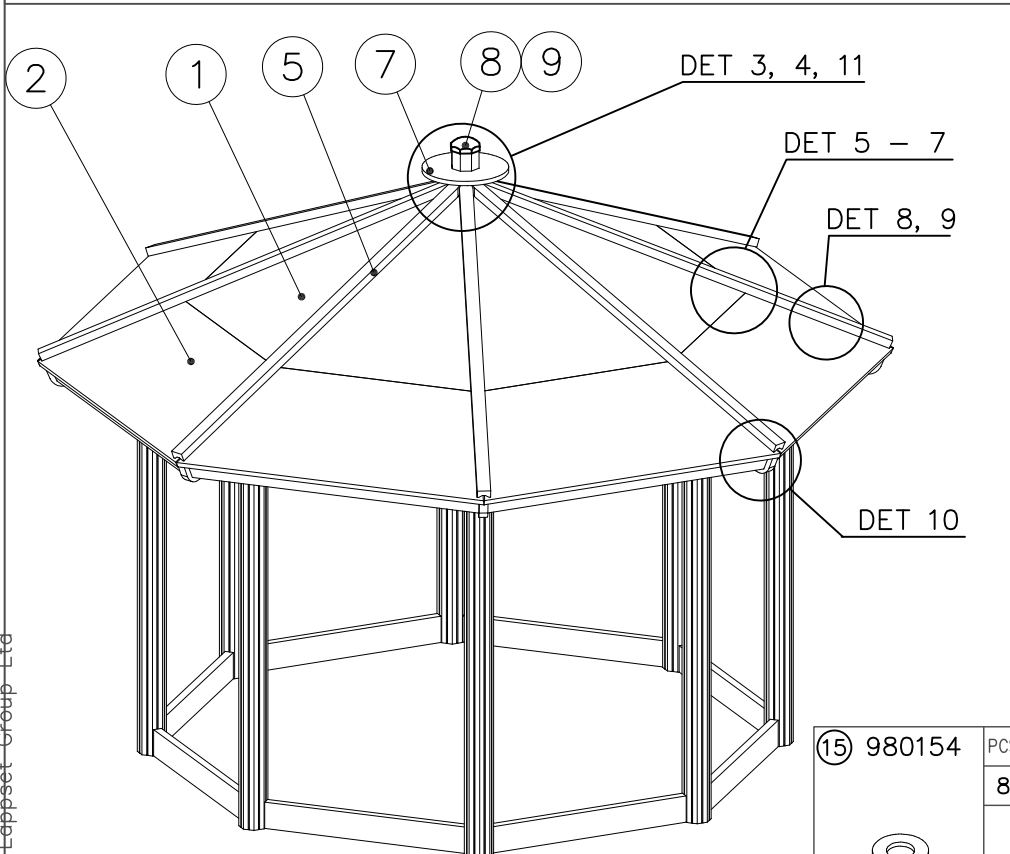

⑨ 905197	PCS	⑩ 909225	PCS
	1		8
BLACK		12x180	
⑪ 980131	PCS	⑫ 908934	PCS
	4		3
6x60		165mm/ 10m	
⑬ 980100	PCS	⑭ 980101	PCS
	4		80
5x60		4.5x70	
⑮ 980154	PCS	⑯ 980104	PCS
	8		16
Ø24/13		5x90	
		⑰ 980105	PCS
			40
		5x120	

<p>DET 1</p> <p>909666 7495 M10</p>	<p>DET 2</p> <p>Ø24/13 12x180 7495 7303</p>	<p>DET 3</p> <p>7499 909666</p>
<p>DET 4</p> <p>5x60</p>	<p>DET 5</p> <p>7493 4.5x70 7495</p>	<p>DET 6</p> <p>7493 7492</p>
<p>DET 7</p> <p>7492 4.5x70</p>	<p>DET 5-7</p> <p>Distribute gaps evenly before final fixing</p>	<p>DET 8</p> <p>908934</p>
<p>DET 9</p> <p>5x120 7496</p>	<p>DET 10</p> <p>7498 5x90</p>	<p>DET 11</p> <p>6x60</p>