

|   |     |  |     |
|---|-----|--|-----|
| ① | PCS |  | PCS |
|   | 1   |  |     |
| ② | PCS |  | PCS |
|   |     |  |     |
| ③ | PCS |  | PCS |
|   |     |  |     |
| ④ | PCS |  | PCS |
|   |     |  |     |

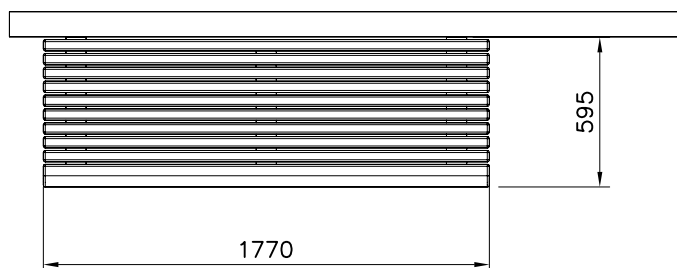
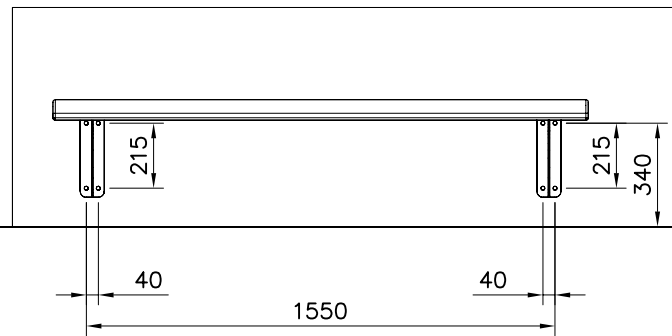
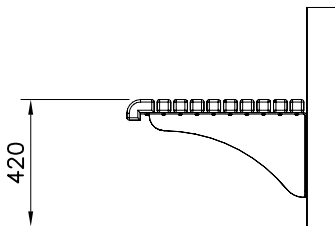
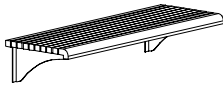
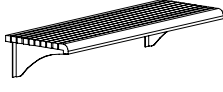
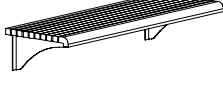
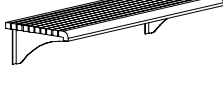

|           |                                                                                                           |          |  |     |  |     |  |     |
|-----------|-----------------------------------------------------------------------------------------------------------|----------|--|-----|--|-----|--|-----|
| 000670    | 003485<br>               | PCS<br>1 |  | PCS |  | PCS |  | PCS |
| 000670-1  | 003485-1<br><br>GRAY     | PCS<br>1 |  | PCS |  | PCS |  | PCS |
| 000670-16 | 003485-16<br><br>CHERRY  | PCS<br>1 |  | PCS |  | PCS |  | PCS |
| 000670-17 | 003485-17<br><br>GREEN | PCS<br>1 |  | PCS |  | PCS |  | PCS |

BETONIIN KIINNITTÄESSÄ, BETONILAATU VÄHINTÄÄN k25.  
FISHCER S-TULPPA S14, KANSIRUUVI 12X90.

MUUNLAISIIN MATERIAALIIN KIINNITTÄESSÄ,  
PULTIN/SEINÄN TMS. KESTETTÄVÄ 500kg/PULTTI.

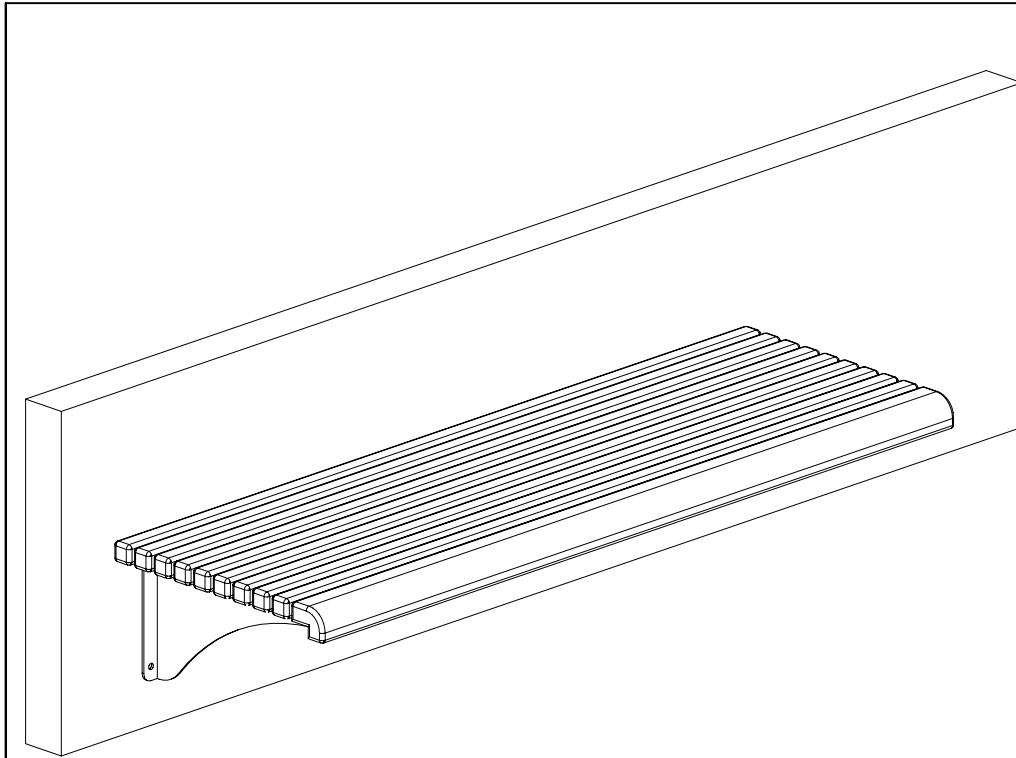

|   |     |  |     |
|---|-----|--|-----|
| ① | PCS |  | PCS |
|   | 1   |  |     |
|   | PCS |  | PCS |
|   |     |  |     |
|   | PCS |  | PCS |
|   |     |  |     |
|   | PCS |  | PCS |
|   |     |  |     |

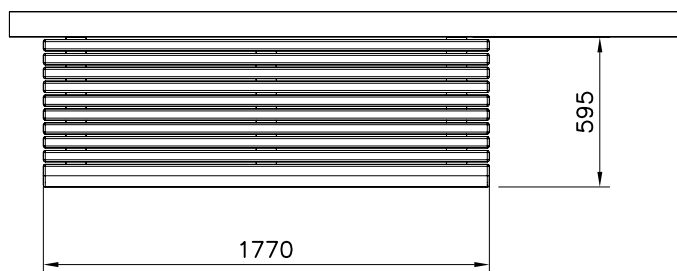
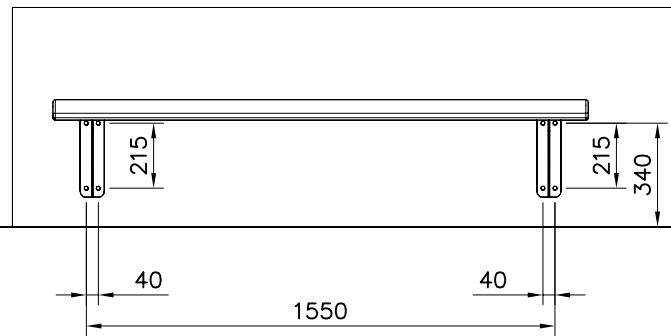
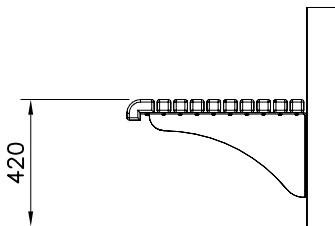

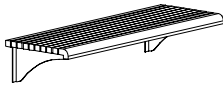
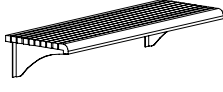
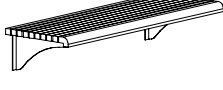
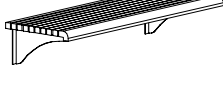
|           |                                                                                                           |          |  |          |          |          |
|-----------|-----------------------------------------------------------------------------------------------------------|----------|--|----------|----------|----------|
| 000670    | 003485<br>               | PCS<br>1 |  | PCS<br>1 | PCS<br>1 | PCS<br>1 |
| 000670-1  | 003485-1<br><br>GRAY     | PCS<br>1 |  | PCS<br>1 | PCS<br>1 | PCS<br>1 |
| 000670-16 | 003485-16<br><br>CHERRY  | PCS<br>1 |  | PCS<br>1 | PCS<br>1 | PCS<br>1 |
| 000670-17 | 003485-17<br><br>GREEN | PCS<br>1 |  | PCS<br>1 | PCS<br>1 | PCS<br>1 |

BETONIIN KIINNITTÄESSÄ, BETONILAATU VÄHINTÄÄN k25.  
 FISHCER S-TULPPA S14, KANSIRUUVI 12X90.

MUUNLAISIIN MATERIAALIIN KIINNITTÄESSÄ,  
 PULTIN/SEINÄN TMS. KESTETTÄVÄ 500kg/PULTTI.