

①	PCS		PCS
	1		
②	PCS		PCS
③	PCS		PCS
④	PCS		PCS

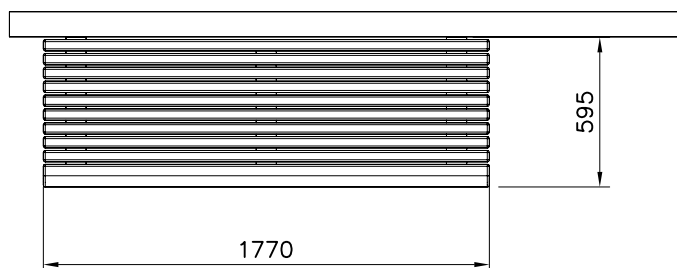
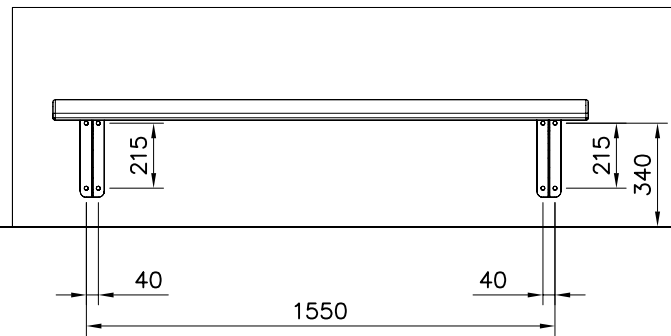
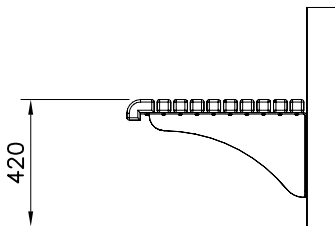
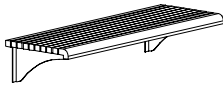
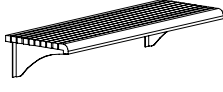
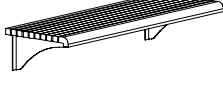
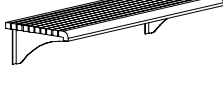

000670	003485 	PCS 1		PCS		PCS		PCS
000670-1	003485-1  GRAY	PCS 1		PCS		PCS		PCS
000670-16	003485-16  CHERRY	PCS 1		PCS		PCS		PCS
000670-17	003485-17  GREEN	PCS 1		PCS		PCS		PCS

BETONIIN KIINNITTÄESSÄ, BETONILAATU VÄHINTÄÄN k25.
FISHCER S-TULPPA S14, KANSIRUUVI 12X90.

MUUNLAISIIN MATERIAALIIN KIINNITTÄESSÄ,
PULTIN/SEINÄN TMS. KESTETTÄVÄ 500kg/PULTTI.

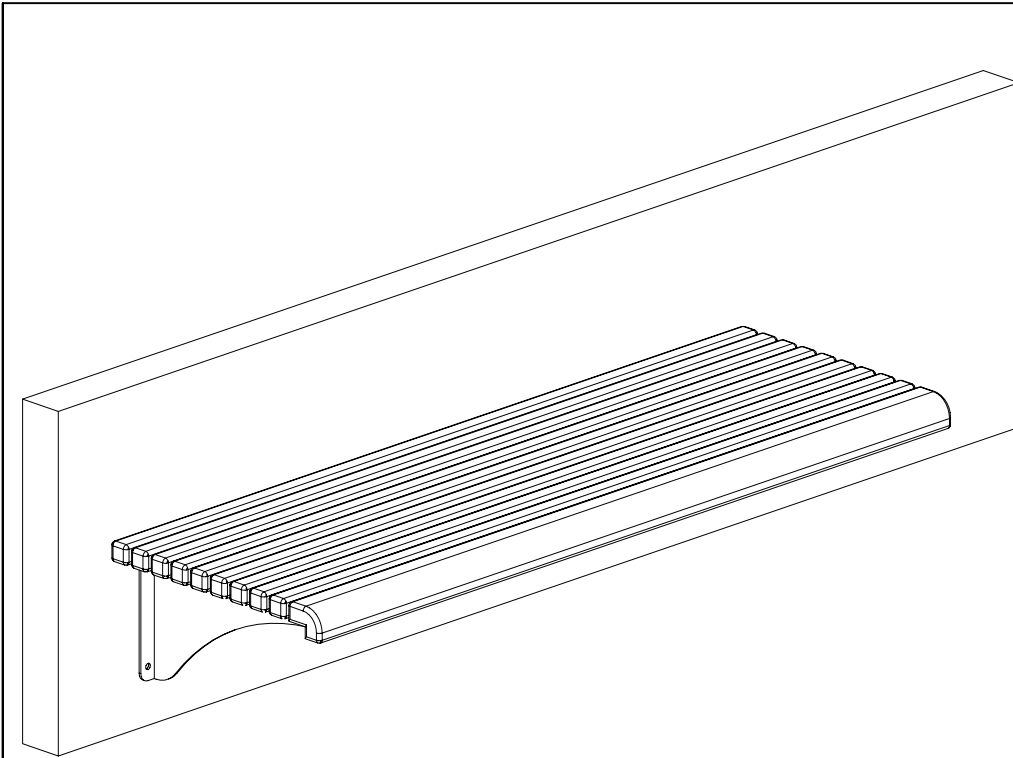

①	PCS		PCS
	1		
②	PCS		PCS
③	PCS		PCS
④	PCS		PCS

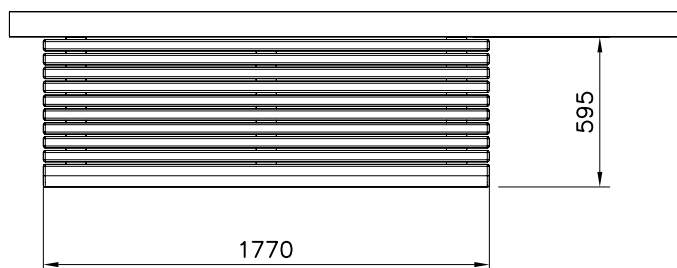
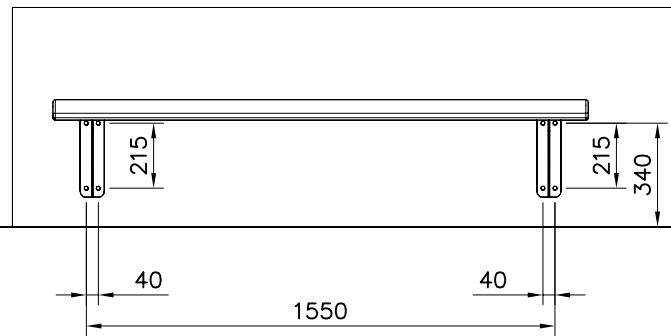
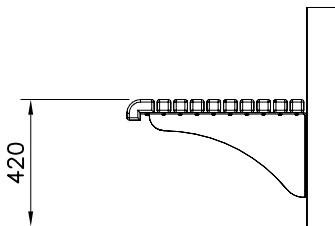

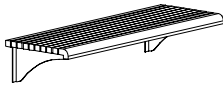
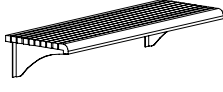
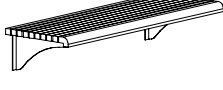
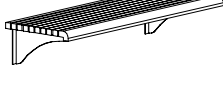
000670	003485 	PCS 1		PCS		PCS		PCS
000670-1	003485-1  GRAY	PCS 1		PCS		PCS		PCS
000670-16	003485-16  CHERRY	PCS 1		PCS		PCS		PCS
000670-17	003485-17  GREEN	PCS 1		PCS		PCS		PCS

BETONIIN KIINNITTÄESSÄ, BETONILAATU VÄHINTÄÄN k25.
FISHCER S-TULPPA S14, KANSIRUUVI 12X90.

MUUNLAISIIN MATERIAALIIN KIINNITTÄESSÄ,
PULTIN/SEINÄN TMS. KESTETTÄVÄ 500kg/PULTTI.