

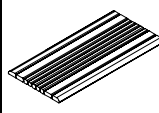

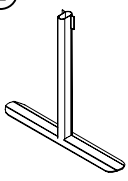

①	PCS	②	PCS
	1		2
③	PCS	④	PCS
	8		16
M8x25		Ø17/8.5 RST	
⑤	PCS		PCS
	8		
M8 A2			
	PCS		PCS



060100	003449 	PCS 1	905215 	PCS 2		PCS		PCS
060100-1	003449-1  GRAY	PCS 1	905215-78  GRAY	PCS 2		PCS		PCS
060100-16	003449-16  CHERRY	PCS 1	905215-80  BEIGE	PCS 2		PCS		PCS
060100-17	003449-17  GREEN	PCS 1	905215-79  GREEN	PCS 2		PCS		PCS
060100-99	003449-99  SPECIAL COLOR	PCS 1	905215-99  SPECIAL COLOR	PCS 2		PCS		PCS

DET 1

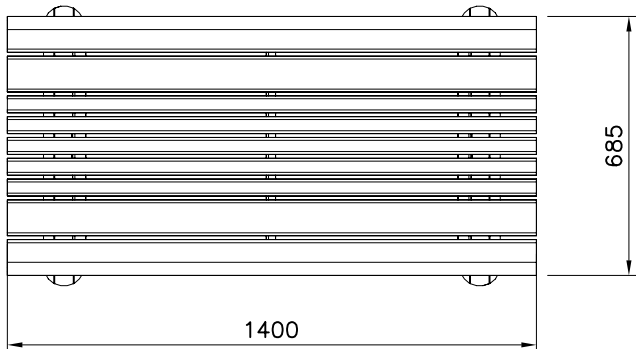
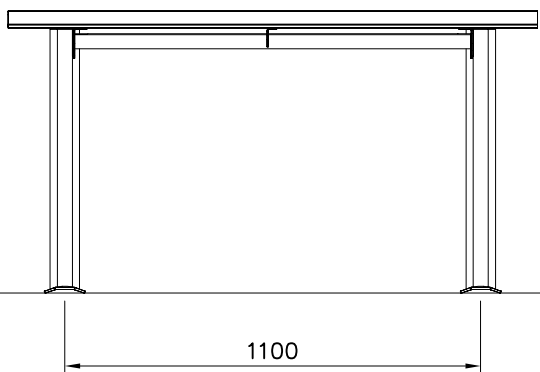
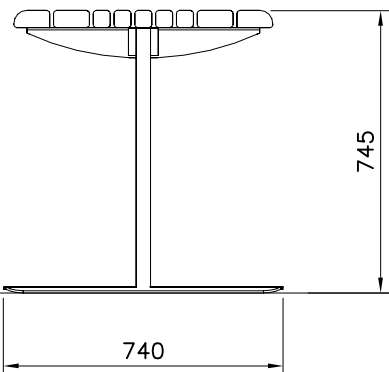
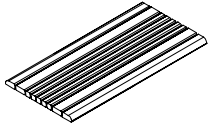
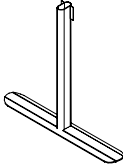
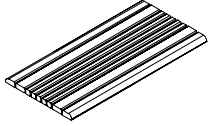
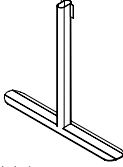
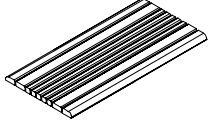
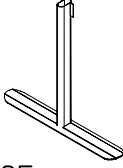
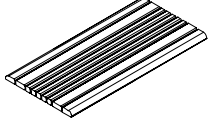
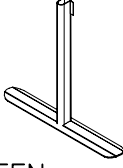
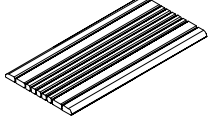
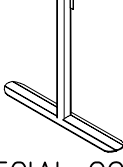
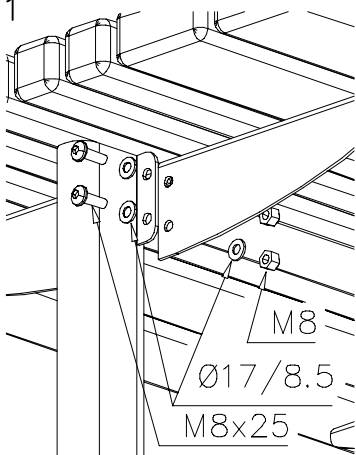

DET 2

DET 3

**Tuotekyltti tulee tuotteen mukana yhdellä seuraavista tavoista:****1) Metallinen tuotekyltti ja kiinnitysruuvit**

- Kiinnitä tuotekyltti ruuveilla tolppaan noin 2 metrin korkeuteen kuvan 1 mukaisesti.

**2) Tuotekylttitarra**

- Puhdista maalattu metalli- tai vaneripinta pölystä ja kosteudesta. Liimaa tarra kuvan 2 mukaisesti.
- Huom. Älä kiinnitä tarraa karheapintaiseen laminaattiin tai maalattuun puuhun.

**Vår produktmärkning levereras på ett av följande sätt:****1) Produktskylt i metall**

- Fäst skylten med de medföljande skruvarna

**2) Självhäftande produktetikett**

- Rengör den pulverlackerade metallytan eller laminatyten så att den blir fri från smuts och fukt. Fäst etiketten enligt fig. 2.
- Obs! Fäst ej etiketten på detaljer med skrovlig yta eller på målat trä.

**Product label is delivered by one of following ways:****1) Metal product label and screws**

- Fasten the label with screws.

**2) Label sticker**

- Clean the painted metal or plywood surface from dirt and moisture. Fasten the sticker as shown in the figure 2.
- Note. Do not attach the sticker to rough surfaced laminate or painted wood.

**La plaque d'informations produit est livrée sous l'une de ces 3 formes :****1) Plaque métallique et vis**

- Fixez la plaque à l'aide des vis.

**2) Etiquette autocollante**

- Avant de coller l'étiquette, nettoyez le composant métallique peint ou la plaque de contreplaqué, de toute saleté. La surface doit être sèche (voir image 2).
- Attention, ne pas coller l'étiquette sur une surface lamellé-collée irrégulière ou sur du bois peint.

**Die Auslieferung des Produktaufklebers erfolgt auf eine dieser Arten:****1) Produkt-Schild aus Metall incl. Schrauben**

- Die Befestigung des Schildes erfolgt mittels der Schrauben.

**2) Aufkleber**

- Entfernen Sie zunächst Schmutz und Feuchtigkeit vom lackierten Metall bzw. von der Holzoberfläche und bringen Sie den Aufkleber wie im Bild oben rechts beschrieben auf den gesäuberten Untergrund auf.
- Beachten Sie: Bringen Sie den Aufkleber nicht auf raues laminiertes oder lackiertes Holz an.