











-  Climbing  
7
-  Dynamic  
1
-  Play panels  
1
-  Roofs  
1
-  Slides  
1
-  Towers  
2

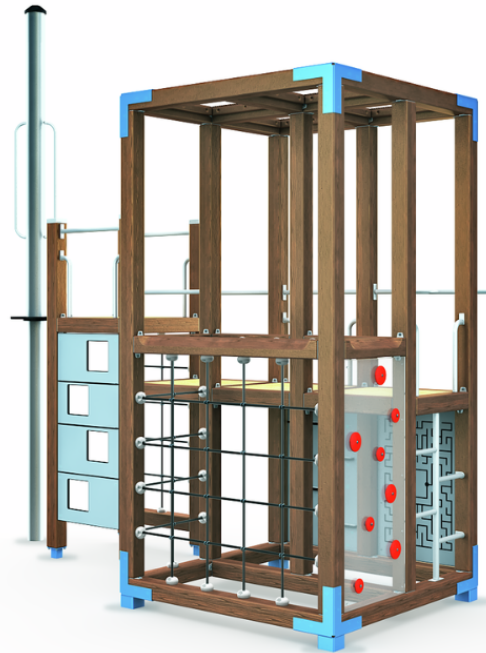
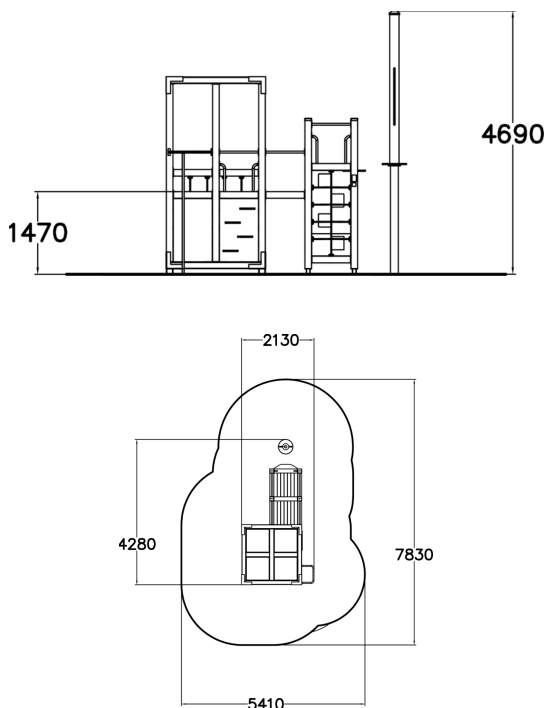

Multifunctional, streamlined tower play with lots of features in a compact space. This equipment includes a climbing wall with square holes, a transparent climbing wall, an ascent with horizontal handles, a ladder rise, four climbing nets, including three vertical nets and one horizontal net, a fireman's pole, a DropZone elevator and a labyrinth game wall. The Drop Zone elevator swirls down and provides a lot of fun play for all ages! The opal white roof of the tower is made of light transmitting cellular plate. Please note, that you can change the deep mounting to surface mounting of the tower part of the product, but the DropZone always requires deep mounting with concrete.



User age	4+
Number of users	18
Product length, mm	4285
Product width, mm	2135
Product height, mm	4685
Impact area, m <sup>2</sup>	33.3
Falling space, m <sup>2</sup>	33.4
Height required, mm	4690
Max. free fall height, mm	1970
Safety info	EN 1176-1 TÜV
Installation time (for 1), H	30
Foundation options	deep_mounting surface_mounting
Wood	
Metal	
Colour of walls and HPL	
Ropes	