

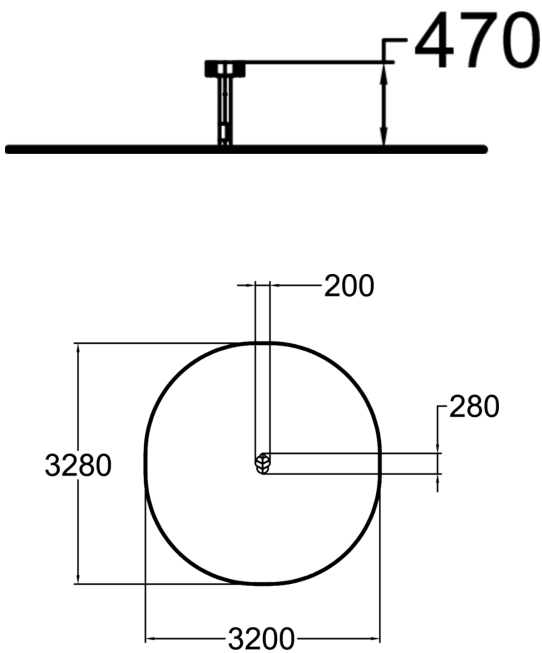

A balancing post with a wooden top on a metal foot. The pretty posts shaped like clover leaves (or pine cones) can be combined, to form balancing routes that are safe even for younger kids thanks to their low height. The posts can be placed in the height of 100-520 mm. With practice, the children will become more adept, increasing their speed and the diversity of their movements! The balancing posts can also be used as seats by children or grown-ups, for a little rest.



User age	3+
Number of users	1
Product length, mm	200
Product width, mm	280
Product height, mm	470
Falling space, m ²	8.6
Height required, mm	2320
Max. free fall height, mm	470
Safety info	EN 1176-1 TÜV
Installation time (for 1), H	1
Foundation options	deep_mounting
Wood	<input checked="" type="checkbox"/>
Metal	<input type="checkbox"/>