







-  Bridges  
1
-  Climbing  
3
-  Play panels  
1
-  Roofs  
2
-  Towers  
2



Activity tower with two towers and a bridge suitable for school yards and parks. Tower can be accessed by ladders, climbing wall or rotating climbing bar, and slide down using the fireman's pole. There is a rubber button under the tower for balancing or hanging out.

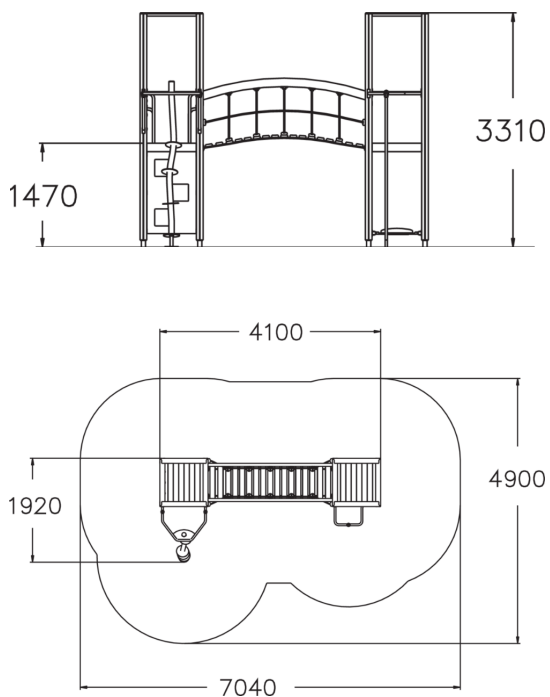
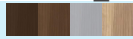

User age	4
Number of users	10
Product length, mm	4100
Product width, mm	1920
Product height, mm	3310
Impact area, m <sup>2</sup>	28.1
Falling space, m <sup>2</sup>	28.1
Height required, mm	3310
Max. free fall height, mm	1580
Safety info	EN 1176-1 TÜV
Installation time (for 1), H	12
Foundation options	deep_mounting surface_mounting
Wood	
Metal	
Colour of walls and HPL	
Ropes	