





-  Climbing
1
-  Roofs
1
-  Slides
2
-  Towers
2



This playground equipment comes with two slides in different sizes. The lower (870 mm) tower can be accessed safely by a ladder. The high (1470 mm) tower can be accessed by rung net, and the exhilarating descent at high speed is via slide. Beneath the tower there is a seat for having a rest amid play.

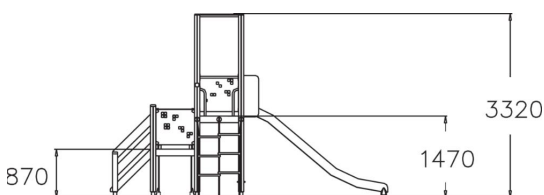
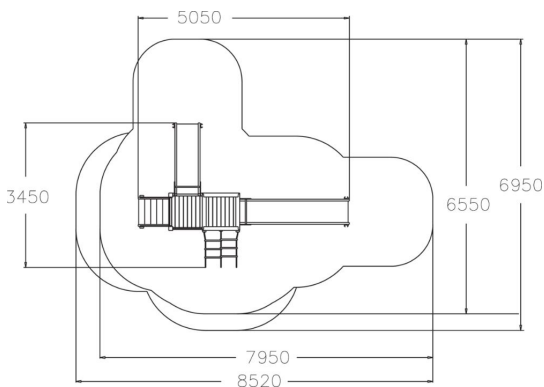

User age	1+
Number of users	8
Product length, mm	5050
Product width, mm	3450
Product height, mm	3320
Impact area, m ²	32.3
Falling space, m ²	35.7
Height required, mm	3360
Max. free fall height, mm	1470
Safety info	EN 1176-1, 3 TÜV
Installation time (for 1), H	10
Foundation options	Deep mounting Surface mounting