







-  Play panels
1
-  Roofs
1
-  Slides
1
-  Towers
1



Playground equipment for younger children, including steps, 870 mm high platform with added play function in the form of a labyrinth wall, and a low slide. Safe and durable, it develops small children's motor skills. An updated version of the traditional slide, which is every child's favourite year after year.

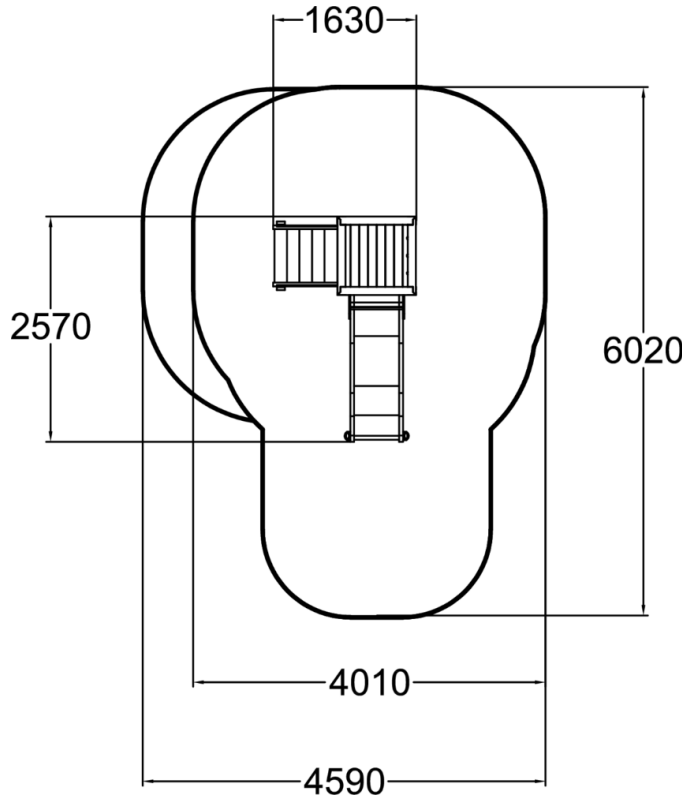
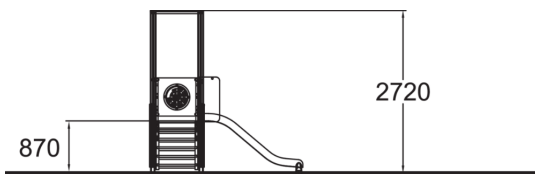

User age	1+
Number of users	3
Product length, mm	1630
Product width, mm	2580
Product height, mm	2720
Impact area, m ²	19
Falling space, m ²	21.2
Height required, mm	2760
Max. free fall height, mm	1000
Safety info	EN 1176-1, 3 TÜV
Installation time (for 1), H	6
Foundation options	deep_mounting surface_mounting
Wood	
Metal	
Colour of walls and HPL	